

Klein®

CATALOG 23.A

Klein

Klein

Klein

Klein



THE NEW WEBSITE IS AN IMPORTANT ACHIEVEMENT SINCE IT LEADS OUR KLEIN BRAND INTO THE DIGITAL WORLD WITH A WHOLE NEW LOOK

sistemiklein.com

The features we have added are crucial for a better experience and faster navigation. Our entire product catalogue is on our website and organised into various sections, all product pages are supported with photos, technical images and details. In 2022 we launched the aluklein.com website dedicated entirely to our tools that work aluminium, plastic and advanced materials.

WHAT'S NEW?

- The main site and the B2B shop are now one single website
- New filters for quick product searches
- Smart search toolbar
- New design and graphics

WHAT ELSE DO WE OFFER?

- Website available in 5 different languages
- Download area with all our catalogues and guides
- Mobile version available
- News about our products and projects



OUR B2B

118166 | Router bits and accessories for CNC machining centers | 02914 Chiusa, 31044-589

COLLET CHUCKS HSK-50F T118

- Supplied with nut (without collet)
- Balanced to 24000 RPM
- Threaded nut DIN 6499 (ER32 - ER40)
- Threaded nut DIN 6388 (EOC25/SVO225/R0035)
- For the spring collets see our item T119 - T123 - T124 - T125. For the clamping nuts see our item Z091 (without ball bearing nut) and/or Z091 (with ball bearing nut). For the wrenches see our item Z092 (standard) and/or Z092 (torque).
- To be used on our adjustable demount device Klein® T129
- These tool holders ensure a maximum error of concentricity between the conical part and the tool's seat of 0,003mm (Runout: 0,0001°)
- The 'A' measure will be determined with clamped tool shanks by using both our spring collets DM6499. The 'A' measure may be subject to variations depending on the diameter of the clamped tools.
- The hollow taper shank is produced according to DIN69892 for inserting the Balluff microchip.
- The ball bearing clamping nut improves the clamping precision thanks to a homogeneous clamping force. It can be used both for the right-hand and left-hand rotation.

[View Catalog](#) [Download PDF](#)

If you are interested in this product:

[CONTACT US](#)

Item	D	Rotation	D1	Spring collets	Clamping nut	Taper	A	Price	Quantity
T118.962.R	42	RH	50	Ø 2-16 (Art. T125/ER25)	Z091.103.R	HSK-50F	60	€146,00 €165,00	Availability 18 Pieces

SHOP PORTAL FOR OUR DEALERS & DISTRIBUTORS

- Prices and item-stock always up-to-date
- Worldwide shipping within 48h
- Private download area with files and catalogues
- Step-by-step tutorial for purchasing
- Complete range of tools for working different materials
- One of the largest selection of tools for the CNC industry

FOLLOW US



Official communications, collaborations and our tools at work



Communications on important events and achievements



Photos and videos of our Klein® tools and partnerships with Influencer and Youtuber



Production videos, tutorial guides and tools at work





**LEADING
MANUFACTURER
OF TOOLS FOR
WOODWORKING,
ALUMINUM AND
PLASTICS FOR
40 YEARS**

OUR HISTORY

Since 1987, the story of Sistemi begins in Pesaro in the Marche region, the land of furniture, kitchen and motors. Like other companies in this area, we initially specialised mostly in supplying equipment and cutting tools for woodworking and wood derivatives, but over the years we have become a leader and reference point in this sector in the world, recognised through our own **Klein** brand.

The company is now a leader in the market thanks to continuous investment in the use of modern and innovative technologies and in the training our staff of specialised technicians, designers and young, dynamic sales experts, who are always ready to meet the demands of global competition.

Today, we export our products to more than 60 countries worldwide, consolidating our presence with the best dealers in the sector, always aiming at "customer satisfaction".



OUR JOB

In order to create products of high quality value, we use the best raw materials.

Their procurement and selection is always managed on an annual basis to ensure a constant supply. In this way, we are able to guarantee more than 10,000 parts ready in stock.

The design of our products starts on CAD stations by specialised technicians who study and design the tools with precision down to the smallest detail in order to always offer a high-performance end product.



OUR PRODUCTION

Production is carried out on state-of-the-art machines, followed by scrupulous inspection using high-precision instruments to guarantee the highest quality of all Klein® products. This makes them suitable for the most scrupulous industry and customers who are increasingly looking for fast production and a highly flexible response to the most varied requirements.

We offer our customers fast and accurate service, speeding up and simplifying delivery, making our customers more and more satisfied every day, not only with our products but also with the service we provide.

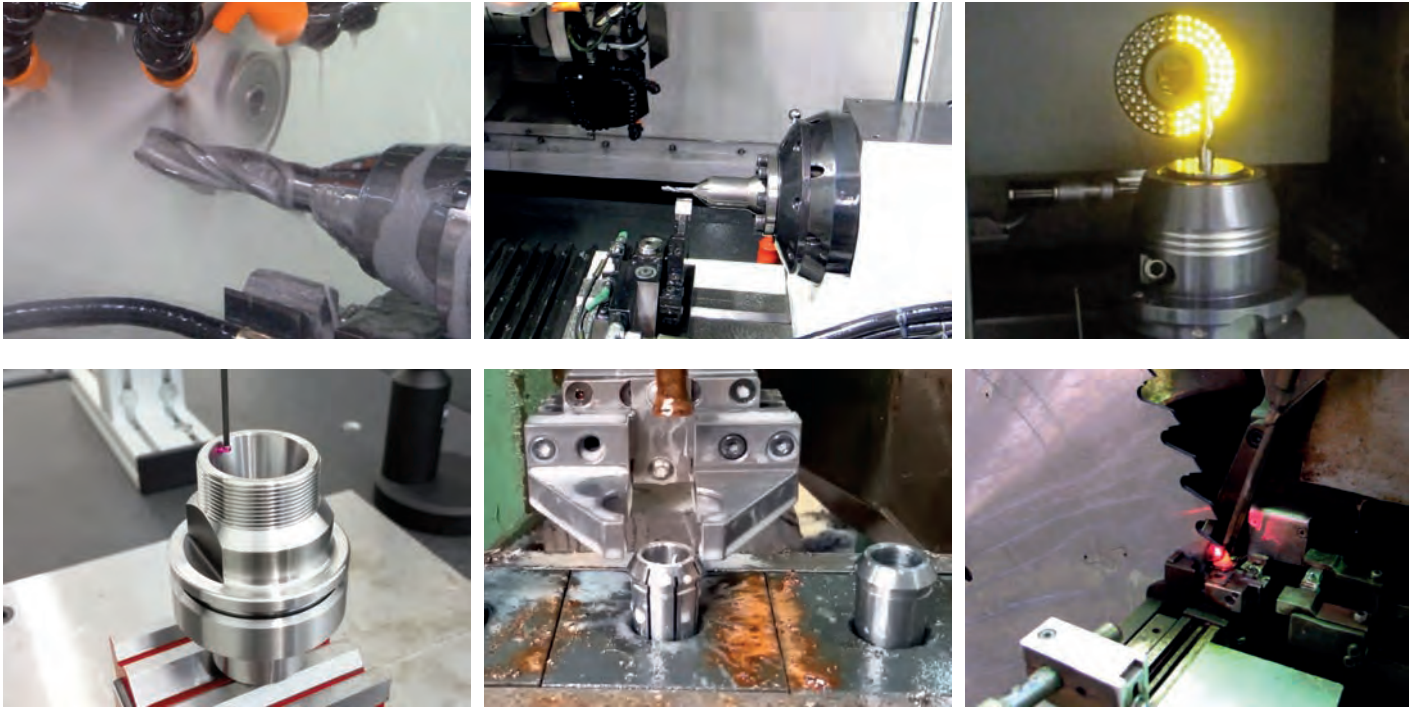

OUR QUALITY AND INNOVATION

We want our company to become a benchmark in our industry. That is why we have made a constant commitment to innovative investments one of the points of our corporate mission. Because we believe that change is necessary to grow and position the company among the market leaders. Our achievement Future Market Inside (FMI) ranked SISTEMI Klein® among the world's leading manufacturers of wood router bits.



■ OUR PHILOSOPHY

At Sistemi, we are customer oriented, we aim for customer satisfaction by carefully examining each stage of the production process and carefully selecting the raw materials that are essential for quality production. Our mission is to bring a valuable product to the market that fully meets your requirements. A high-performance and excellent product that is able to withstand prolonged use, hits and heavy pressure. Our items are made only of the best raw materials and by skilful and experienced people.



Made in
ITALY

■ MADE IN ITALY BY SISTEMI KLEIN®

Quality and 'Made in Italy' are our cornerstones. We are promoters of Italian products throughout the world, and we constantly invest in high quality raw materials and modern machines and cutting-edge production processes. The concept of 'Made in Italy' is recognised all over the world for its study, dedication, technological innovation and the quality that derives from it, elements that we, at Sistemi, place in the manufacture of every single product. We are scrupulous in our choice of high-level product components to create high-performance finished products that do not disappoint our customers' expectations. In addition, we also pay attention to the quality of the tools and we use only presetters and automatic process to check the quality of the final products, because a top-quality collet chuck, sawblade, drill bits and router bits is only such if valuable and innovative equipment is used in the production process.



■ INNOVATION AND MODERNITY

This cannot be possible without the right investments in innovation. Indeed, company and production renewal needs to be carried out periodically in order to adapt the company to the innovations that the market demands. We at Sistemi are constantly investing in the most cutting-edge technology in our industry, so that we can always offer you the best product. Innovation is the key that will project our company into the future and open the doors to new markets and scenarios.

OUR GREEN POLICY

Here at Sistemi, we care about the health and welfare of the planet, and we have been using only recyclable materials for packaging marked with the logo already since some years now. Furthermore, as waste management has increasingly become a problem of global importance, we strive every day to separate waste in order to limit its entry into landfills.



■ PLASTIC

Many types of plastics can be easily recycled, so we have decided that all packaging made of plastic material should be 100% recyclable and identified by the Unicode code, which covers the number identification of recyclable plastics.



■ PAPER AND CARDBOARD

All our packaging using paper and cardboard is Resy branded, which indicates the raw material, paper and cardboard that are 100% recycled and recyclable. In addition, printing our User Manuals, product brochures and price lists in-house has helped us to reduce our consumption of paper for commercial purposes by around 50%.



■ INKS AND GLUES

Everything that is printed for Sistemi uses vegetable oil-based inks and glues that fully meet the company's ecological goal of reducing VOCs (Volatile Organic Compounds) and making printed products easier to recycle.



■ SOLAR PANELS

Ensuring our children a greener future by focusing on renewable energy is what led us at Sistemi to choose a photovoltaic panel solar system. The project is part of the company's increasingly strong commitment to environmental protection and respect. The installation of the photovoltaic solar panels above the factory roof was inaugurated in January 2011 and is aimed at producing green energy for the Company. Thanks to this system, approximately 10,000 kg of CO2 emissions corresponding to 1,500 trees are saved each year.

OUR DISTRIBUTION

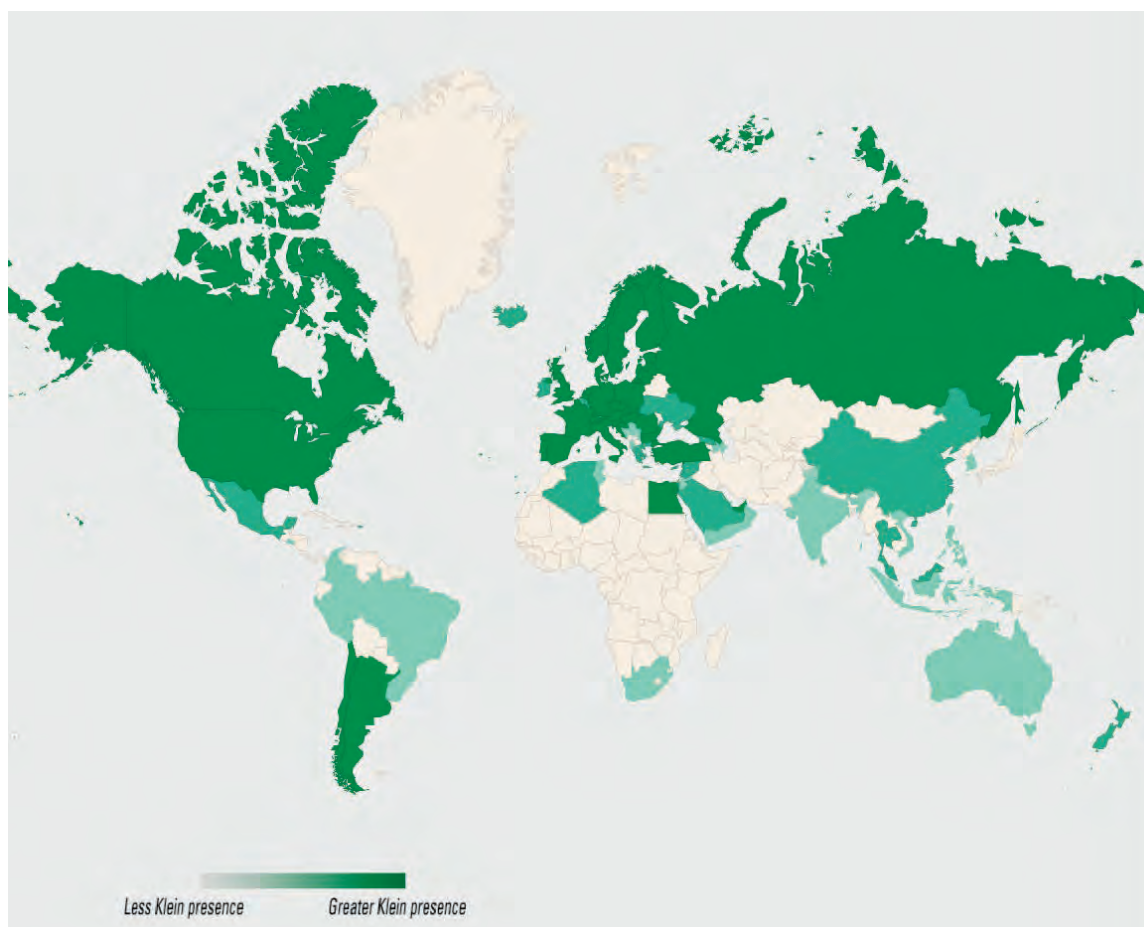

At Sistemi, we export our product to more than 60 countries around the world. We have developed a sales network in the main European Union, Asian and United States of America countries so that we cover the main international markets ready to satisfy every need and demand.



OUR ACHIEVEMENT

- SISTEMI SRL WAS FOUNDED** ● **1987**
- **1990** Sistemi introduced the Electronic Bench for dimensional control of the panel
- Sistemi introduced the **Klein** brand ● **1991**
- **1992** First Xylexpo exhibition in Milan, where Arkade+ Zinkel was presented
- Opening of representative office for the American market ● **1993**
- **1996** Cooperation with m.conti: presets for tool control - new website
- Sistemi completed its equipment for the Arkade+ Zinkel with the Ellix system ● **1997**
- **2000** Sistemi moved to its current headquarters and added circular saw blades to its catalogue
- New Trimatic Super line and the entire Catalogue was also made available online ● **2003**
- **2010** Sistemi opened up to the Chinese market and the gauge line was expanded with radio frequency gauges
- At the Xylexpo exhibition in Milan the new Catalogue 14.A was presented with Tornado® ● **2014**
- **2015** The new version of the online Sistemi Klein® website was launched
- Three new brands were introduced onto the market: KleinDIA® - XtraBore® HotBlock® ● **2016**
- **2020** Future Market Inside (FMI) ranked SISTEMI Klein® among the world's leading manufacturers of wood router bits
- Company expansion and new warehouse for storage to ensure faster shipments ● **2021**
- **2022** ALUKlein® and realisation of the new corporate website
- New WEBSITE ● **2023**

OUR BRANDS

SISTEMI

Since 1987, the story of **SISTEMI** begins in Pesaro in the Marche region, the land of furniture, kitchen and motors.

Klein®

Sistemi introduced the Klein® brand, a trademark of **SISTEMI**

KleinDIA®

KleinDIA® is a DLC (Diamond-like Carbon) anti-friction coating which allows to solve problems of tool abrasion, chip evacuation and chemical attack.

ALUKlein

Full range of tools for the industrial processing of aluminium, PVC, plastic, advanced materials and wood

KleinItaly®

The Klein Italy brand was born from the need to distinguish Klein products in the foreign market as Made in Italy.

trimatic®

The Trimatic® product line was created in 1998 as the first and original drilling jig, to drill 3 or more holes at the same time with centre-to-centre distance suitable for mounting the most well-known hinges (Salice, Blum, Hettich, ...).

Tornado®

The first model of Tornado® was introduced in the market in March 2014 experiencing a great success among worker and machinery operators due to its great results.

HotBlock®

HotBlock® shrink-fit chucks in its catalog, together with the corresponding heat-shrinking machine (K.START.2) and cooling (K.FG.500) machines.

Xtra® bore

















Following the 2016 catalog update, the new ExtraBore® coated solid carbid drill bits for automatic multiboring machines were added.

Xtra® cut

ExtraCut® is the next level of premium quality saw blades. Silents slots are filled with a special synthetic plastic resin placed for greater stability and reduced vibration.

CATALOGUE SECTIONS

The catalogue is divided into **16** sections of which the first **14** dedicated to tools, the n. 15 to measuring instruments and the n.16 to special equipment.

























<p>ROUTER BITS FOR HAND PORTABLE ROUTER MACHINES S=Ø6 - S=Ø1/4" -S=Ø8</p>		<p>1</p> 
<p>ROUTER BITS FOR HAND PORTABLE ROUTER MACHINES S=Ø10 - S=Ø12 - S=Ø1/2"</p>		<p>2</p> 
<p>ROUTER BITS FOR WOOD, CHIPBOARDS AND SOLID SURFACE MATERIALS</p>		<p>3</p> 
<p>ROUTER BITS FOR HANDPORTABLE ROUTER MACHINES "ECONOMY LINE"</p>		<p>4</p> 
<p>DOWEL DRILLS AND BORING BITS FOR AUTOMATIC BORING MACHINES</p>		<p>5</p> 
<p>BORING BITS AND SLOT MORTISING BITS FOR PORTABLE DRILLS</p>		<p>6</p> 
<p>SOLID CARBIDE SPIRAL CUTTERS, TOOLHOLDERS AND ACCESSORIES FOR CNC ROUTER MACHINES</p>		<p>7</p> 
<p>ROUTER BITS FOR ALUMINIUM, PLASTIC AND ADVANCED MATERIALS</p>	 <p>Klein</p>	<p>8</p> 

<p>INSERT KNIVES ROUTER BITS AND DP DIAMOND ROUTER BITS</p>		<p>9</p> 
<p>SPARE PARTS</p>		<p>10</p> 
<p>REVERSIBLE KNIVES AND KNIVES FOR PLANERS</p>		<p>11</p> 
<p>SAWBLADES</p>		<p>12</p> 
<p>CUTTERHEADS</p>		<p>13</p> 
<p>LUBRICANTS, DIAMOND GRINDING WHEELS AND DIAMOND STONES</p>		<p>14</p> 
<p>MEASURING INSTRUMENTS</p>		<p>15</p> 
<p>SPECIAL DEVICES</p>	 	<p>16</p> 

EXPLANATION OF SYMBOLS

Softwood		CORIAN®		Lock ring	
Hardwood		Lumber		O-ring	 
Wood with small metal residues		Paper coated materials		Center bit	
MDF		Fibre cement		Allen keys	
Aluminium wood profiles		Fiberglass		Torx keys	
"Sandwich" panels		HPL		Wrenches	
Single side laminated boards		Plastic materials		Wrenches for collet nut "standard"	
Double side laminated boards		Plexiglass		Torque wrenches for "mini" nuts	
Single side veneer boards		Aluminium		Torque wrenches for "standard" nuts	
Double side veneer boards		PVC		Torque wrenches for TORNADO®	
Playwood		Steel and ferrous materials		Torque hook wrenches	
Chipboard		Cooper		Torque wrenches for "no-noise" nuts	
Plastic coated materials		Brass		Torque wrenches for "torx" screws	
				Torque wrenches for "torx" screws	
				Knives 2 cutting edges	
				Knives 4 cutting edges	
				Spurs	
				Profiled knives	
				Versofix knives	
				Hanging packaging	
				Hanging packaging "Hobby"	
				Shims	
				Ball bearings	
				Spacers	
				Threaded nuts	

EXPLANATION OF SYMBOLS

Spurs	
Washers	
Spring washers	
Seeger	
Spacers	
Wedges	
Cheese head screws	
Countersunk head screws	
Allen screws	
Countersunk flat head screws	
Rounded head screws	
Slotted cheese head screws	
Screws for "Weeke" machines	
Adjustable demount devices	
Electric router	
Work table mounted router	
Drill press	
Portable drill	
CNC	
RPM 12.000	
RPM 24.000	
RPM 34.000	
RPM 36.000	
RPM 40.000	
BALLUFF POCKET	

MATERIALS ABBREVIATIONS (as per norm EN 847-1)

SP	Alloyed tool steel
HL	High-alloy tool steel
HS	High speed steel
HW	Uncoated hardmetal on tungsten carbide base
DP/PCD	Polycrystalline diamond
VHW	Solid tungsten carbide

TECHNICAL ABBREVIATIONS

mm	Millimeter
Z	Number of teeth
\varnothing	Diameter
Sp.	Thickness
RH	Right hand rotation
LH	Left hand rotation
Mat.	Type of material
FF	Hollow end cap
FP	Extended end cap
MK2	Collet chuck with morse taper shank (2)
MK3	Collet chuck with morse taper shank (3)
RPM	Rounds per minute
Nm	Newton / Meter
MAN	Manual feed
MEC	Mechanical feed
CNC	Computered Numerical Control
DIN	German Industry Standard
ISO	International Organization of Standardization
D	Diameter
B	Cutting length
R	Radius
L	Total length
E	Cutting depth
α	Angle
S	Shank
d	Bore
A	Dimension A
B/l	Cutting length/throat reduction
C	Knife thickness
B/c	Teeth kerf/body thickness
V	Spurs
LP	Profilable length
Ch	Keyways

INDUSTRIAL ROUTER BITS FOR HAND PORTABLE ROUTER MACHINE AND ROUTER TABLE



STRAIGHT AND TRIMMING ROUTER BITS
Router bits specially designed to work at different cutting heights and diameters. In addition to the lateral cutting edges, many of them also have a third cutting edge at the head to perform drilling operations (Z=2+1).

See page 1.07-1.09 / 1.14-1.15 / 1.21



SLOT CUTTER AND ASSEMBLY ROUTER BITS
Router bits for all the types of jointing. The ball bearing guide defines the depth of the cut, ideal for grooves, frames, doors and edges.

See page 1.13-1.14



ROUTER BITS WITH INTERCHANGEABLE KNIVES
The interchangeable knife is easy to replace and provide an excellent precision and cutting accuracy with the best quality/price ratio. Longer tool life and better finishing quality.

See page 1.26-1.27



RADIUS AND PROFILE ROUTER BITS
All the router bits with a profile or shape on the cutting edge allow you to decorate the wood as you wish. Some of them have a ball bearing guide.

See page 1.15-1.21



ENGRAVING AND DECORATING ROUTER BITS
Router bits for all the types of jointing. Router bits with a special "V" or "U" head profile let you carve wood easily and precisely. These router bits are useful for lettering, incision signmaking and decorations on wood.

See page 1.11-1.12



SPIRAL ROUTER BITS
The spiral solid carbide router bits have a special design, which guarantees an extremely precise and clean cut because the cutting edges facilitate the wood chips expulsion.

See page 1.09

ROUTER BITS FOR HAND PORTABLE ROUTER MACHINES

S=Ø6 - S=Ø1/4" - S=Ø8



VHW STRAIGHT BITS
Pag. 1.07



VHW STRAIGHT BITS
Pag. 1.07



VHW DOUBLE FLUSH TRIMMING BITS
Pag. 1.08



HW MORTISING PILOT BITS Z=2
Pag. 1.08

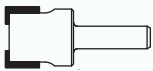

HW HINGE MORTISING BITS Z=2
Pag. 1.08



HW PLUNGE TYPE STRAIGHT BITS Z=2+1
Pag. 1.08



SOLID CARBIDE SPIRAL CUTTERS, UPCUT
FINISH STYLE Z=2
Pag. 1.09



SOLID CARBIDE SPIRAL CUTTERS,
DOWNCUT FINISH STYLE Z=2
Pag. 1.09



SOLID CARBIDE SPIRAL CUTTERS,
FINISH STYLE Z=2
Pag. 1.09



SOLID CARBIDE COMPRESSION
CUTTERS Z=2+2
Pag. 1.09



SOLID CARBIDE COMPRESSION CUTTERS
Z=2+2 WITH DOUBLE BALL BEARING
Pag. 1.09



HW PANEL PILOT BITS Z=1+1
Pag. 1.10



HW DOUBLE PANEL PILOT BITS
Pag. 1.10



HW BEVEL TRIM BITS Z=2
Pag. 1.10



HW BEVEL TRIM BITS Z=2
Pag. 1.10

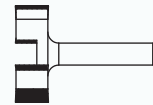

HW ROUTER BITS FOR
PLANING AND RABBETING Z=4
Pag. 1.10

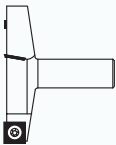

HW INSERT ROUTER BITS FOR
PLANING AND RABBETING Z=3
Pag. 1.10



VHW DOVETAIL BITS Z=2
Pag. 1.11

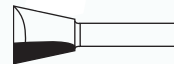

HW DOVETAIL BITS Z=2
Pag. 1.11

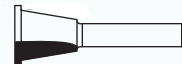

HW DOVETAIL BITS Z=2
Pag. 1.11



HW V-GROOVE AND
SIGNMAKING BITS
Pag. 1.11



VHW V-GROOVE AND
SIGNMAKING BITS Z=1
Pag. 1.11



VHW U-GROOVE AND SIGNMAKING BITS
Pag. 1.12

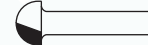

HW CORE BOX BITS Z=2
Pag. 1.12



HW PLUNGING ROUND-OVER BITS Z=2
Pag. 1.12

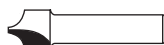

HW PLUNGING ROUND-OVER BITS Z=2
Pag. 1.12



HW PLUNGE TYPE OGEE BITS Z=2
Pag. 1.12



HW PLUNGE TYPE TRADITIONAL
BITS Z=2
Pag. 1.12

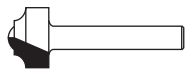

HW PLUNGE TYPE CLASSICAL BITS Z=2
Pag. 1.12



HW BULL NOSE RADIUS BITS Z=2
Pag. 1.13

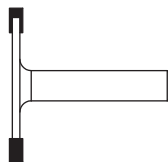

T-SLOT HW CUTTERS Z=4
Pag. 1.13

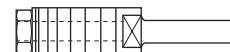

SLOT CUTTER ARBORS
Pag. 1.13

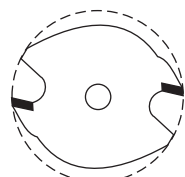

HW SLOT CUTTERS Z=2
Page 1.13

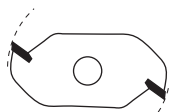

HW SLOT CUTTERS Z=2
Page 1.13

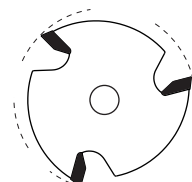

HW SLOT CUTTERS Z=3
Page 1.13

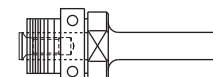

SLOT CUTTER ARBORS
Page 1.14

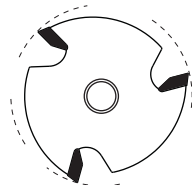

HW SLOT CUTTERS SPECIAL
FIXING SCREW Z=3
Page 1.14



HW TRIMMING BITS
WITH BALL BEARING Z=2
Page 1.14



HW TRIMMING BITS
WITH BALL BEARING Z=2
Page 1.15

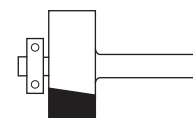

HW RABBETTING BITS
WITH BALL BEARING Z=2
Page 1.15

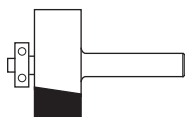

HW RABBETTING BITS WITH
BALL BEARING Z=2
Page 1.15



HW BEVEL TRIM BITS
WITH BALL BEARING Z=2
Page 1.15

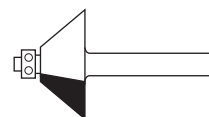

HW BEVEL TRIM BIT WITH
BALL BEARING GUIDE
Page 1.15

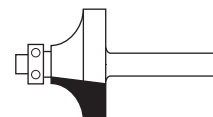

HW CORNER ROUNDING BITS
WITH BALL BEARING Z=2
Page 1.16



HW CORNER ROUNDING BITS WITH
DELRIN® BALL BEARING Z=2
Page 1.16

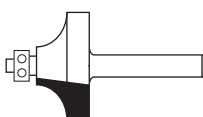

HW BEADING BITS
WITH BALL BEARING GUIDE Z=2
Page 1.16

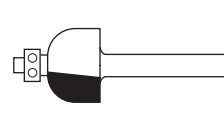

HW COVER BITS
WITH BALL BEARING GUIDE Z=2
Page 1.16

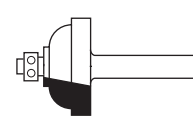

HW DOUBLE FILLET COVE BITS
WITH BALL BEARING GUIDE Z=2
Page 1.17



HW ROMAN OGEE BITS
WITH BALL BEARING GUIDE Z=2
Page 1.17



HW DOUBLE ROMAN OGEE BITS Z=2
Page 1.17



HW OGEE BITS
WITH BALL BEARING GUIDE Z=2
Page 1.17



HW OGEE BITS
WITH BALL BEARING GUIDE Z=2
Page 1.17

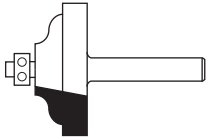

HW OGEE BITS
WITH BALL BEARING GUIDE Z=2
Page 1.18

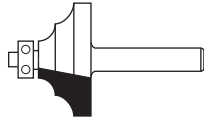

HW CLASSICAL MOULDING BITS
WITH BALL BEARING GUIDE Z=2
Page 1.18



HW CORNER BEADING BITS
WITH BALL BEARING GUIDE Z=2
Page 1.18

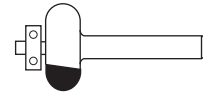

HW EDGE-FLUTING BITS
WITH BALL BEARING GUIDE Z=2
Page 1.18

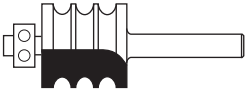

HW MULTI-BEADING BITS
WITH BALL BEARING GUIDE Z=2
Page 1.18



HW FLUSH-TRIM "V" GROOVE BITS WITH
BALL BEARING GUIDE Z=2
Page 1.19

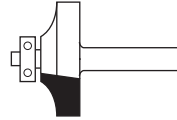

HW FLAT ROUNDING OVER BITS
WITH BALL BEARING GUIDE Z=2
Page 1.19

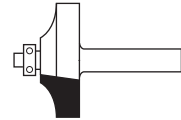

HW FLAT ROUNDING OVER BITS
WITH BALL BEARING GUIDE Z=2
Page 1.19

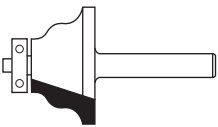

HW PROFILE BITS
WITH BALL BEARING GUIDE
Page 1.19

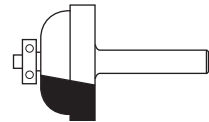

HW FLAT OGEE BITS WITH
BALL BEARING GUIDE Z=2
Page 1.19

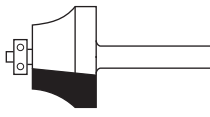

HW OVOLO JOINT BITS WITH
BALL BEARING GUIDE Z=2
Page 1.19



HW OGEE BITS
WITH BALL BEARING GUIDE Z=2
Page 1.20



HW PANEL PILOT BITS WITH
BALL BEARING GUIDE Z=1
Page 1.20



HW FLUSH AND BEVEL TRIM BITS Z=2
Page 1.20

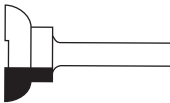

HW FINGER GRIP BITS Z=2
Page 1.20



HW FLUSH AND BEVEL TRIM BITS
WITH BALL BEARING GUIDE Z=2
Page 1.20

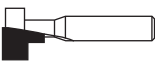

HW KEYHOLE BITS (T-SLOT)
Page 1.20



HW CONVEX EDGING BITS Z=2
Page 1.20

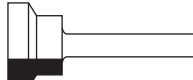

HW DRAWER LOCK BITS Z=2
Page 1.21

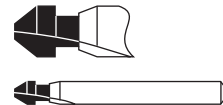

HW SEAL PROFILE BITS Z=2
Page 1.21

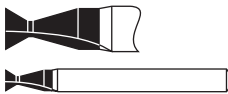

HW DOVETAIL SEAL BITS Z=2
Page 1.21



HW SEAL BITS Z=2
Page 1.21



HW FLUSH TRIM BITS WITH
UPPER BALL BEARING GUIDE Z=2
Page 1.21



HW "MINI" FLUSH TRIM BITS WITH
UPPER BALL BEARING GUIDE Z=2
Page 1.21

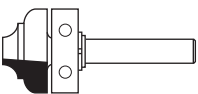

HW FLUSH TRIM BITS WITH
UPPER BALL BEARING GUIDE Z=2
Page 1.22

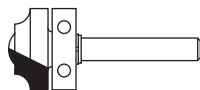

HW FLUSH TRIM BITS WITH
UPPER BALL BEARING GUIDE Z=2
Page 1.22

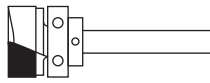

HW FLUSH TRIM BITS WITH
UPPER BALL BEARING GUIDE Z=2
Page 1.22

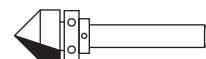

HW GROOVE BITS WITH
UPPER BALL BEARING GUIDE Z=2
Page 1.22

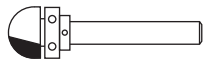

HW CORE BOX BITS WITH UPPER BALL BEARING GUIDE Z=2
Page 1.22

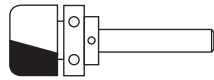

HW BOWL AND TRAY BITS WITH UPPER BALL BEARING Z=2
Page 1.22

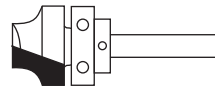

HW FLUSH TRIM BITS WITH UPPER BALL BEARING GUIDE Z=2
Page 1.23

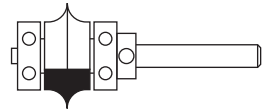

HW "LEAF-EDGE" BEADING BITS WITH DOUBLE BALL BEARING GUIDE Z=2
Page 1.23

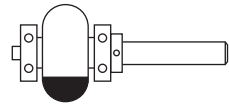

HW "EDGE-FLUTING" BITS WITH DOUBLE BALL BEARING GUIDE Z=2
Page 1.23

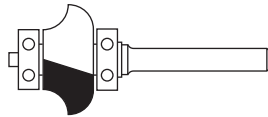

HW RADIUS BITS WITH DOUBLE BALL BEARING GUIDE Z=2
Page 1.23



HW DOUBLE DIAMETER BITS Z=2
Page 1.23

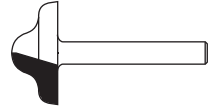

HW DOUBLE RADIUS BITS Z=2
Page 1.24

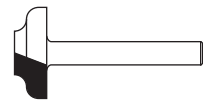

HW DOUBLE RADIUS BITS Z=2
Page 1.24

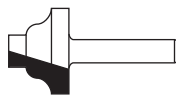

HW DOUBLE RADIUS BITS Z=2
Page 1.24

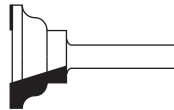

HW DOUBLE RADIUS BITS Z=2
Page 1.24



HW MULTI RADIUS BITS Z=2
Page 1.24

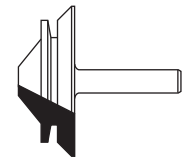

HW 45 DEGREE LOCK MITRE JOINT BITS Z=2
Page 1.24

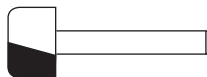

HW BOWL AND TRAY BITS Z=2
Page 1.24

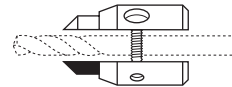

HW ADJUSTABLE COUNTERSINKS Z=2
Page 1.25

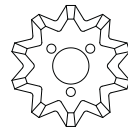

HS FLUSH TRIMMERS FOR TABLE EDGE BANDING MACHINES
Page 1.25

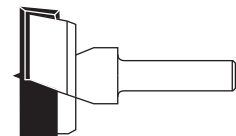

HW BORING BITS
Page 1.25

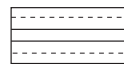

BUSHINGS
Page 1.25



SPACERS
Page 1.25



HW INSERT FLUSH TRIMMING BITS Z=1
Page 1.26

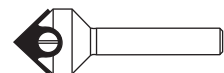

HW INSERT V-GROOVING BITS Z=1
Page 1.26

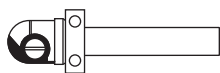

HW INSERT CORE BOX BITS WITH UPPER BALL BEARING Z=1
Page 1.26



HW INSERT FLUSH TRIMMING BITS WITH BALL BEARING
Page 1.26

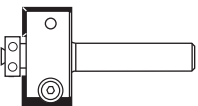

HW INSERT RABBET BITS WITH BALL BEARING Z=2
Page 1.26



HW INSERT FLUSH TRIMMING BITS WITH BALL BEARING Z=2
Page 1.26

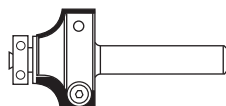

HW INSERT CORNER ROUNDING BITS WITH BALL BEARING Z=2
Page 1.27

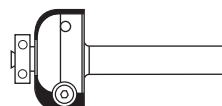

HW INSERT COVER BITS WITH BALL BEARING Z=2
Page 1.27

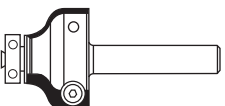

HW INSERT OGEE BITS WITH BALL BEARING Z=2
Page 1.27



HW INSERT FLUSH TRIMMING BITS Z=2
Pag. 1.27



HW INSERT FLUSH TRIMMING BITS Z=2
Pag. 1.27



HW INSERT FLUSH TRIMMING BITS WITH
UPPER ANF LOWER BALL BEARINGS Z=2
Pag. 1.27



6 PIECE STRAIGHT-DOVETAIL INSERT
ROUTER BITS "STARTER SET"
Page 1.28



6 PIECE PROFILE ROUTER
BITS "STARTER SET"
Page 1.28



6 PIECE STRAIGHT BITS
"STARTER SET"
Page 1.29



6 PIECE CORNER ROUNDING
BITS "STARTER SET"
Page 1.29



6 PIECE DOVETAIL BITS
"STARTER SET"
Page 1.30



12 PIECE CLASSICAL ROUTER BITS
"STARTER SET"
Page 1.31



12 PIECE STRAIGHT ROUTER
BITS "ADVANCED SET"
Page 1.32



12 PIECE PROFILE ROUTER BITS
"ADVANCED SET"
Page 1.33



12 PIECE DOVETAIL BITS
"ADVANCED SET"
Page 1.34



12 PIECE CORNER ROUNDING
BITS "ADVANCED SET"
Page 1.35



6 PIECE INSERT ROUTER BITS "SET"
Page 1.36



6 PIECE INSERT ROUTER BITS "SET"
Page 1.36



DISPLAYS
Page 1.37

ROUTER BITS FOR PORTABLE ROUTERS

The router bits KLEIN® are high quality products which can satisfy the most important applications required by the market today. In order to maintain the high quality level achieved during these years, our production departments have been continually equipped with latest technology and machinery along with more versatile and modern management systems. Moreover we always put a constant attention in the choice of raw materials, such as the development of a special TCT in collaboration with our suppliers, which allow our straight router bits KLEIN® to be at the top of the market for performance, precision and cutting life, ensuring excellent results and even better than our competitors'. An important aspect is also the wideness and variety of our range of router bits. In the catalogue KLEIN®, in fact, there are more than a thousand different items which meet any particular requirements, whether in the industrial or handcrafted manufacture.



ANTI-STICK INDUSTRIAL BURNISHED COATING which ensures protection against rust, corrosion and build-up

TRI-METAL BRAZING OPERATION (alloy+copper+alloy) for best performance and maximum resistance to stress

CERTIFIED INDUSTRIAL CARBIDE to guarantee longer lifetime, sharp cutting edge and best finishing

SHEAR-ANGLE especially designed to obtain smoother cuts compared to competitors

ANTI-KICKBACK DESIGN that reduces the problem of the initial kickback of the piece of wood, ensuring maximum safety

LASER MARKING as a guarantee of the operator, a number of specifications are marked on the cutter shank

QUALITY CONTROL

At Klein in order to best ensure the performance and sharpness of each product, we use both a manual and camera Presetter inspection process to minimize the margin of error and ensure technical specifications.



THE PACKAGING

Eco-friendly packaging with 100% recyclable plastic and paper. The internal card displays technical drawing, features and more



MAINTENANCE

A correct cutter care is essential in order to preserve cutter performance and prolong its life. Keeping in mind our advices will guarantee the maximum tool protection, increasing its productive efficiency. Read and download our guide online here



VHW STRAIGHT BITS

ART. A101/2/3 - B101/2/3 - C101/2/3

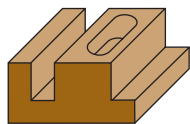
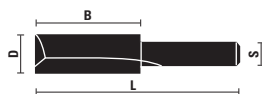

- Solid carbide
- Straight cut and plunging (Z=2+1)
- To be used also for working plastic materials, acrylic, polypropylene, acetates and polycarbonates



S Ø 6	S Ø 1/4" (6,35)	S Ø 8	D	B	L	Z
A101.015.R			1,5	4	46	2+1
A101.020.R	B101.020.R		2	4	46	2+1
	B101.024.R		2,4	6	46	2+1
A101.025.R			2,5	8	48	2+1
A101.030.R	B101.030.R	C101.030.R	3	11	51	2+1
	B101.032.R		3,2	11	51	2+1
A101.040.R	B101.040.R	C101.040.R	4	11	51	2+1
	B101.048.R		4,8	11	51	2+1
A101.050.R		C101.050.R	5	11	51	2+1
A101.060.R	B101.060.R	C101.060.R	6	19	51	2+1
	B101.064.R		6,4	19	51	2+1
A101.070.R	B101.070.R	C101.070.R	7	19	51	2+1
A101.080.R	B101.080.R	C101.080.R	8	19	51	2+1
	B102.048.R		4,8	16	55	2+1
A102.050.R		C102.050.R	5	16	55	2+1
A102.060.R	B102.060.R	C102.060.R	6	25	57	2+1
	B102.064.R		6,4	25	57	2+1
A102.080.R	B102.080.R	C102.080.R	8	25	57	2+1
A103.080.R	B103.080.R	C103.080.R	8	32	63	2+1



Z=2+1

Table for the choice of straight router bits

Items	Soft wood	Hard wood	Composite
A/B/C 101-102 VHW	XXX	XXX	XXX
A/B/C 101-102 HW brazed	XX	XXX	XXX

HW STRAIGHT BITS

ART. A101/2/3 - B101/2/3 - C101/2/3

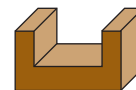
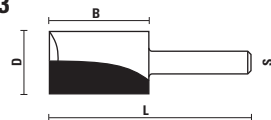

- Straight cut
- Z=2+1 also plunging



S Ø 6	S Ø 1/4" (6,35)	S Ø 8	D	B	L	Z
A101.090.R		C101.090.R	9	19	51	2
	B101.095.R		9,5	19	51	2
A101.100.R	B101.100.R	C101.100.R	10	19	51	2
A101.101.R		C101.101.R	10	19	51	2+1
A101.110.R	B101.110.R	C101.110.R	11	19	51	2
A101.120.R	B101.120.R	C101.120.R	12	19	51	2
A101.121.R		C101.121.R	12	19	51	2+1
	B101.127.R		12,7	19	51	2
A101.130.R		C101.130.R	13	19	51	2
A101.140.R	B101.140.R	C101.140.R	14	19	51	2
A101.141.R		C101.141.R	14	19	51	2+1
A101.150.R	B101.150.R	C101.150.R	15	19	51	2
A101.160.R	B101.160.R	C101.160.R	16	19	51	2
A101.161.R		C101.161.R	16	19	51	2+1
A101.170.R		C101.170.R	17	19	51	2
A101.180.R	B101.180.R	C101.180.R	18	19	51	2
A101.181.R		C101.181.R	18	19	51	2+1
A101.190.R	B101.190.R	C101.190.R	19	19	51	2
		C101.191.R	19	19	51	2+1
A101.200.R	B101.200.R	C101.200.R	20	19	51	2
A101.201.R		C101.201.R	20	19	51	2+1
A101.210.R		C101.210.R	21	19	51	2
A101.220.R	B101.220.R	C101.220.R	22	19	51	2
A101.221.R		C101.221.R	22	19	51	2+1
		C101.240.R	24	19	51	2
A101.250.R		C101.250.R	25	19	51	2
	B101.254.R		25,4	19	51	2
	B102.095.R		9,5	25	57	2
A102.100.R	B102.100.R	C102.100.R	10	25	57	2
A102.101.R		C102.101.R	10	25	57	2+1
A102.120.R	B102.120.R	C102.120.R	12	25	57	2
A102.121.R		C102.121.R	12	25	57	2+1
	B102.127.R		12,7	25	57	2
		C102.140.R	14	25	57	2
A102.160.R	B102.160.R	C102.160.R	16	25	57	2
A102.161.R		C102.161.R	16	25	57	2+1
	B103.095.R		9,5	32	63	2
A103.100.R	B103.100.R	C103.100.R	10	32	63	2
A103.120.R	B103.120.R	C103.120.R	12	32	63	2
	B103.127.R		12,7	32	63	2
A103.150.R			15	32	63	2
A103.160.R	B103.160.R	C103.160.R	16	32	63	2

Straight bits sets in wooden case see page 1.28 and 1.31

VHW DOUBLE FLUSH TRIMMING BITS

ART. A101

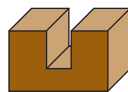

Solid carbide

S Ø 6	D	B	L	Z
A101.031.R	3	11	65	2+1

HW MORTISING PILOT BITS Z=2

ART. A104 - B104 - C104

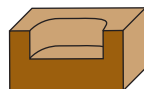
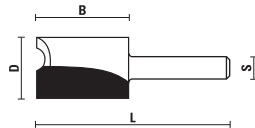

S Ø 6	S Ø 1/4" (6,35)	S Ø 8	D	B	L
A104.127.R	B104.127.R	C104.127.R	12,7	19	51
A104.160.R	B104.160.R	C104.160.R	16	19	51
A104.190.R	B104.190.R	C104.190.R	19	19	51

HW HINGE MORTISING BITS Z=2

ART. A104

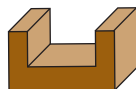
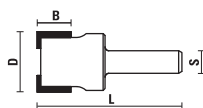

Suitable for routing lateral shallow recesses such as hinge leaves or general large shallow cuts, thanks to the shorter length. Especially made with lateral slots for better chip evacuation.

S Ø 6	D	B	L
A104.580.R	8	9	37
A104.600.R	10	9	37
A104.620.R	12	9	37
A104.630.R	13	9	37
A104.640.R	14	9	37
A104.650.R	15	9	37
A104.660.R	16	9	37
A104.670.R	17	9	37
A104.680.R	18	9	37
A104.700.R	20	9	37
A104.710.R	21	9	37
A104.720.R	22	9	37
A104.730.R	23	9	37
A104.740.R	24	9	37
A104.750.R	25	9	37
A104.800.R	30	9	37

HW PLUNGE TYPE STRAIGHT BITS Z=2+1

ART. C190

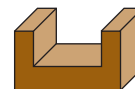
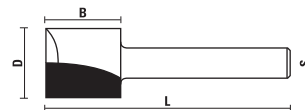

- Straight cut
- Z=2+1 also plunging

S Ø 8	D	B	L	Z
C190.030.R ▲	3	10	55	2+1
C190.040.R ▲	4	12	55	2+1
C190.050.R ▲	5	14	55	2+1
C190.060.R ▲	6	16	55	2+1
C190.070.R ▲	7	18	55	2+1
C190.080.R ▲	8	20	55	2+1
C190.081.R ▲	8	40	90	2+1
C190.090.R ▲	9	20	55	2+1
C190.100.R ▲	10	20	55	2+1
C190.101.R	10	30	70	2+1
C190.102.R	10	40	90	2+1
C190.120.R	12	20	60	2+1
C190.121.R	12	20	100	2+1
C190.122.R	12	30	70	2+1
C190.123.R	12	40	90	2+1
C190.140.R	14	20	60	2+1
C190.141.R	14	20	100	2+1
C190.142.R	14	40	90	2+1
C190.150.R	15	20	70	2+1
C190.160.R	16	20	70	2+1
C190.161.R	16	20	100	2+1
C190.162.R	16	40	90	2+1
C190.163.R	16	30	70	2+1
C190.180.R	18	20	70	2+1
C190.181.R	18	30	70	2+1
C190.182.R	18	40	90	2+1
C190.200.R	20	20	70	2+1
C190.201.R	20	20	100	2+1
C190.202.R	20	30	70	2+1
C190.203.R	20	40	90	2+1
C190.220.R	22	16	70	2+1
C190.221.R	22	20	100	2+1
C190.222.R	22	30	70	2+1
C190.223.R	22	40	90	2+1
C190.240.R	24	16	70	2+1
C190.241.R	24	30	70	2+1
C190.250.R	25	16	70	2+1

▲ Solid Carbide

Z=2+1



VISIT OUR WEBSITE
www.sistemiklein.com



HW SOLID CARBIDE SPIRAL CUTTER FOR PORTABLE AND CNC ROUTERS

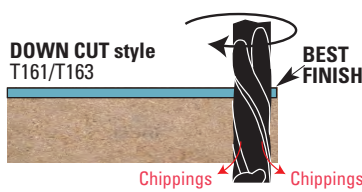
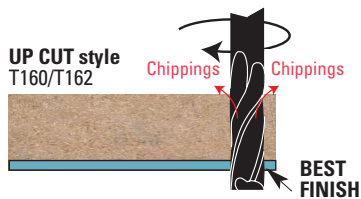
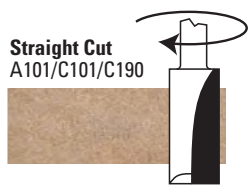

SOLID CARBIDE SPIRAL CUTTERS, UPCUT FINISH STYLE Z=2

ART. T160 - T162

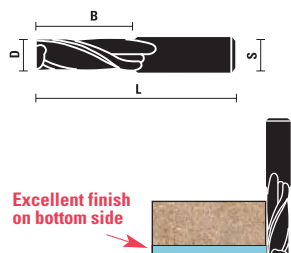

- Can also be used on portable routers
- Right-hand rotation with "UP CUT SPIRAL"



S Ø 6	S Ø 8	D	B	L	Z
T160.030.R	T162.030.R	3	12	60	2
T160.035.R		3,5	14	60	2
T160.040.R	T162.040.R	4	14	60	2
T160.045.R		4,5	16	60	2
T160.050.R	T162.050.R	5	17	60	2
	T162.060.R	6	22	70	2
	T162.070.R	7	32	80	2

SOLID CARBIDE SPIRAL CUTTERS, FINISH STYLE Z=2

ART. T164

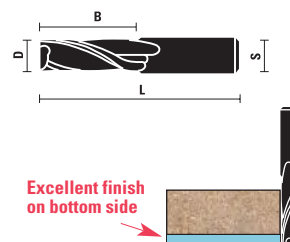

- Can also be used on portable routers
- Right-hand rotation with "UP CUT SPIRAL"

RH rotation	D	B	L	S	Z
T164.032.R	1/8"	1/2"	2"	1/4"	2
T164.048.R	3/16"	3/4"	2"	1/4"	2

SOLID CARBIDE COMPRESSION CUTTERS Z=2+2

ART. T156

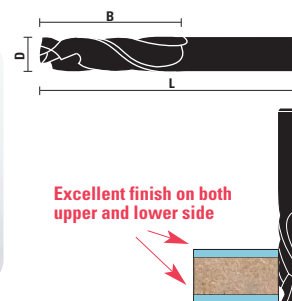

- Right-hand rotation with double flute, compression spiral
- To be used on machining centres, CNC routers and point to point machines



S Ø 8	D	B	L	Z
T156.080.R	8	22	80	2+2
T156.081.R	8	32	80	2+2

SOLID CARBIDE COMPRESSION CUTTERS Z=2+2 WITH DOUBLE BALL BEARING

ART. T166

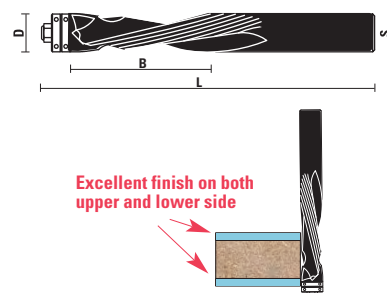

- Right-hand rotation with double flute compression spiral (UP & DOWN).
- Double ball bearings guide for greater precision of trimming
- Special spiral geometry which provides better chip evacuation and smoother cuts on laminate panels.



S Ø 8	D	B	L	Z
T166.080.R NEW	8	36	95	2+2



SOLID CARBIDE SPIRAL CUTTERS, DOWNCUT FINISH STYLE Z=2

ART. T161 - T163

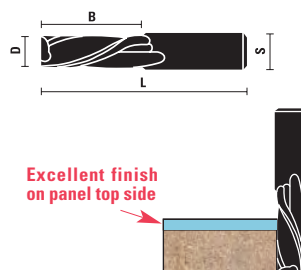

- Can also be used on portable routers
- Right-hand rotation with "DOWN CUT SPIRAL"



S Ø 6	S Ø 8	D	B	L	Z
T161.030.R	T163.030.R	3	12	60	2
T161.035.R		3,5	14	60	2
T161.040.R	T163.040.R	4	14	60	2
T161.045.R		4,5	16	60	2
T161.050.R	T163.050.R	5	17	60	2
	T163.060.R	6	22	70	2
	T163.070.R	7	32	80	2

HW PANEL PILOT BITS Z=1+1

ART. A105 - B105 - C105

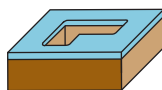

Ideal for working laminated panels

S Ø 6	S Ø 1/4" (6,35)	S Ø 8	D	B	L
A105.060.R ▲			6	19	63
A105.064.R	B105.064.R	C105.064.R	6,4	19	63
		C105.080.R	8	19	63

▲ Solid carbide

HW DOUBLE PANEL PILOT BITS

ART. A106 - C106

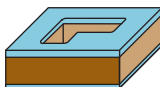
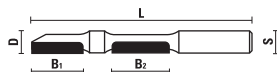

Ideal for working laminated panels top and bottom side

S Ø 6	S Ø 8	D	B1	B2	L
A106.060.R	C106.060.R	6	18	18	75

HW BEVEL TRIM BITS Z=2

ART. A107 - B107 - C107

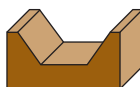
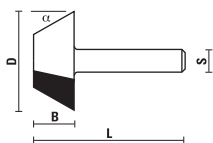

S Ø 6	S Ø 1/4" (6,35)	S Ø 8	D	α	B	L
A107.127.R	B107.127.R		12,7	15°	13	51
A107.143.R	B107.143.R		14,3	10°	16	45
A107.222.R	B107.222.R	C107.222.R	22,2	23°	10	38
A107.254.R	B107.254.R	C107.254.R	25,4	30°	10	38
A107.350.R	B107.350.R	C107.350.R	35	45°	10	38

HW BEVEL TRIM BITS Z=2

ART. A107 - B107 - C107

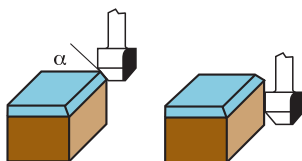
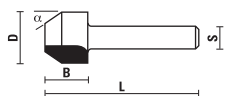

S Ø 6	S Ø 1/4" (6,35)	S Ø 8	D	α	B	L
A107.030.R	B107.030.R	C107.030.R	12,7	30°	12,7	41
A107.045.R	B107.045.R	C107.045.R	12,7	45°	12,7	41

HW ROUTER BITS FOR PLANING AND RABBETING Z=4

ART. C175

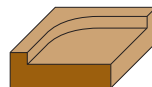
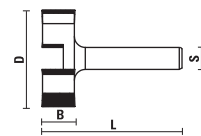

Used for surfacing MDF and particle board and making deep rabbet

S Ø 8	D	B	L	Z
C175.350.R NEW	35	12	51	4

HW INSERT ROUTER BITS FOR PLANING AND RABBETING Z=3

ART. WC190

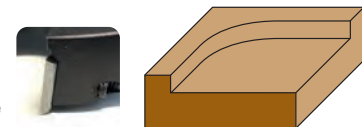
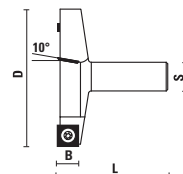

10° shear angle

- Used for surfacing MDF and particle board and making deep rabbet
- 10° shear angle for better performance
- Suitable for processing ever kind of wood with portable router and CNC
- This item is sold complete with a torx key



S Ø 8	D	B	L	Z
WC190.350.R NEW	35	10,5	60	3



Z051.210.R



Z055.016.N



Z052.201.N

VHW DOVETAIL BITS Z=2

ART. A108 - C108



- To use for joints "Hoffmann" system.
- For frames, matchboards, drawers, window and door frames, pallets and wood products in general

S Ø 6	S Ø 8	D	α	B	L	Nr.
A108.053.R ▲		5,3	17°	4	43	1
A108.078.R ▲		7,8	18°	6	43	2
A108.093.R ▲		9,3	19°	7,5	43	3
	C108.161.R	15,8	20°	13	43	4

▲ Solid carbide

Dowel pin nr. 1



Dowel pin nr. 2



Dowel pin nr. 3



Dowel pin nr. 4



HW DOVETAIL BITS Z=2

ART. A108 - B108 - C108

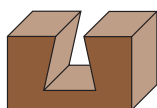
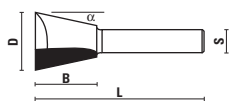

S Ø 6	S Ø 1/4" (6,35)	D	α	B	L
A108.064.R ▲	B108.064.R	6,4	7°	8	63
A108.080.R ▲	B108.080.R	8	9°	9,5	63
A108.095.R	B108.095.R	9,5	9°	9,5	42
A108.127.R	B108.127.R	12,7	14°	13	45
A108.150.R		15	12°	14,5	58
A108.160.R	B108.160.R	16	7°	16	45
A108.190.R	B108.190.R	19	7°	19	65

▲ Solid carbide



S Ø 8	D	α	B	L
C108.064.R	6,4	7°	8	44
C108.080.R	8	9°	9,5	42
C108.095.R	9,5	9°	9,5	47
C108.127.R	12,7	14°	13	49
C108.150.R	15	12°	14,5	61
C108.160.R	16	7°	16	49
C108.190.R	19	14°	19	55
C108.191.R	19	7°	19	60

HW V-GROOVE AND SIGNMAKING BITS

ART. A109 - B109 - C109 / A110 - B110 - C110

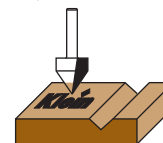
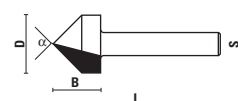

- Item A110.140.R (B110.140.R) C110.140.R are also known as "laser point" for superior incisions
- Suitable for engravings and sign writing with 60°

S Ø 6	S Ø 1/4" (6,35)	S Ø 8	D	α	B	L	Z
A109.060.R ▲		C109.060.R	6	90°	8	45	2
A109.095.R	B109.095.R	C109.095.R	9,5	90°	11	45	2
A109.127.R	B109.127.R	C109.127.R	12,7	90°	13	45	2
A109.160.R	B109.160.R	C109.160.R	16	90°	13	45	2
A109.190.R		C109.190.R	19	90°	16	45	2
A109.254.R	B109.254.R	C109.254.R	25,4	90°	19	48	2
		① C109.380.R	38	90°	20	63	2
A110.127.R	B110.127.R	C110.127.R	12,7	60°	16	45	2
A110.140.R	B110.140.R	C110.140.R	14	60°	22	57	3
		② C110.190.R	19	45°	25	63	2

▲ Solid carbide

①-② Items for working plasterboard panels

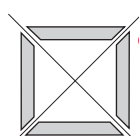

① Bit makes a 45° chamfer that can be used to build square share

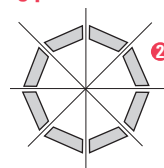

② Bit makes a 22,5° chamfer that can be used to build a B-side box (to an octagonal)

VHW V-GROOVE AND SIGNMAKING BITS Z=1

ART. A109 - B109

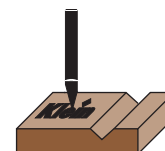

- Suitable for engraving, signmaking and decorative features on wood, plastic, brass, aluminium, copper and different composite material

S Ø 6	S Ø 1/4" (6,35)	D	α	B	L	Z
A109.510.R	B109.510.R	0,1	30°	14	50	1
A109.525.R	B109.525.R	0,25	30°	14	50	1
A109.550.R	B109.550.R	0,5	30°	14	50	1
A109.600.R	B109.600.R	1	30°	14	50	1



HW DOVETAIL BITS Z=2

ART. A108 - B108 - C108

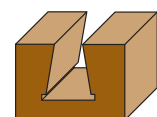
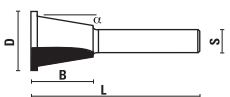

S Ø 6	S Ø 1/4" (6,35)	S Ø 8	D	α	B	L
A108.143.R	B108.143.R	C108.143.R	14,3	13°	13,5	55

Dovetail bits sets in wooden case see page 1.29 and 1.33

VHW U-GROOVE AND SIGNMAKING BITS

ART. A111

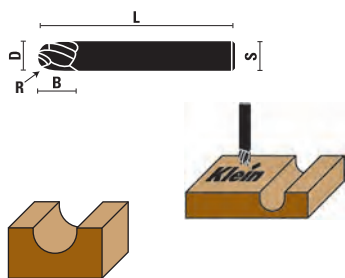

- Solid carbide
- Suitable for engravings and sign writing



S Ø 6	D	R	B	L	Z
A111.060.R	6	3	9	60	3

HW CORE BOX BITS Z=2

ART. A111 - B111 - C111

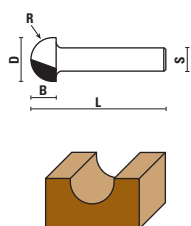

S Ø 6	S Ø 1/4" (6,35)	S Ø 8	D	R	B	L
A111.032.R ▲	B111.032.R	C111.032.R	3,2	1,6	10	44
A111.048.R ▲	B111.048.R	C111.048.R	4,8	2,4	13	44
A111.064.R ▲	B111.064.R	C111.064.R	6,4	3,2	13	44
A111.080.R ▲	B111.080.R	C111.080.R	8	4	13	47
A111.095.R	B111.095.R	C111.095.R	9,5	4,8	7	38
A111.127.R	B111.127.R	C111.127.R	12,7	6,4	10	38
A111.160.R	B111.160.R	C111.160.R	16	8	11	40
A111.180.R	B111.180.R	C111.180.R	18	9	19	47
		C111.190.R	19	9,5	11	47
		C111.200.R	20	10	19	47
		C111.220.R	22	11	14	45
A111.254.R		C111.254.R	25,4	12,7	17	47

▲ Solid carbide

HW PLUNGING ROUND-OVER BITS Z=2

ART. A112 - B112 - C112

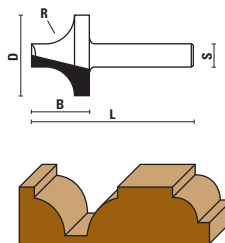

S Ø 6	S Ø 1/4" (6,35)	S Ø 8	D	R	B	L
A112.140.R		C112.140.R	14	4	13	41
A112.160.R		C112.160.R	16	5	13	41
A112.180.R		C112.180.R	18	6	13	41
A112.190.R	B112.190.R	C112.190.R	19	6,4	13	41
A112.220.R		C112.220.R	22	8	14,5	43
A112.254.R	B112.254.R	C112.254.R	25,4	9,5	16	44
		C112.350.R	35	12,7	25,4	63

HW PLUNGING ROUND-OVER BITS Z=2

ART. C112

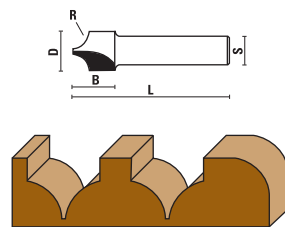

S Ø 8	D	R	B	L
C112.030.R	8	3	10	50
C112.040.R	10	4	10	50
C112.050.R	12	5	10	50

HW PLUNGE TYPE OGEE BITS Z=2

ART. A113 - B113 - C113

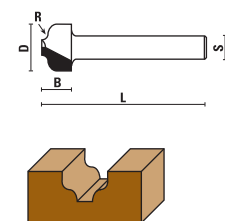

S Ø 6	S Ø 1/4" (6,35)	S Ø 8	D	R	B	L
A113.095.R		C113.095.R	9,5	1,6	8	51
A113.127.R	B113.127.R	C113.127.R	12,7	2	10	51
A113.190.R	B113.190.R	C113.190.R	19	3,5	13	54

HW PLUNGE TYPE TRADITIONAL BITS Z=2

ART. A114 - C114

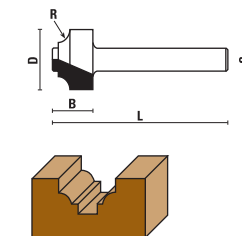

S Ø 6	S Ø 8	D	R	B	L
A114.127.R	C114.127.R	12,7	2	10	51
A114.190.R	C114.190.R	19	3,5	11	52

HW PLUNGE TYPE CLASSICAL BITS Z=2

ART. A115 - B115 - C115

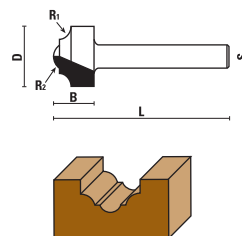

S Ø 6	S Ø 1/4" (6,35)	S Ø 8	D	R1	R2	B	L
A115.127.R	B115.127.R	C115.127.R	12,7	2,5	3,5	10	51
A115.190.R	B115.190.R	C115.190.R	19	3,7	4	13	54
		C115.254.R	25,4	5	6,4	17,5	73

HW BULL NOSE RADIUS BITS Z=2

ART. A116 - B116 - C116

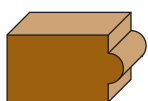
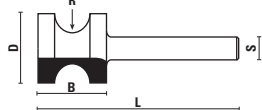

S Ø 6	S Ø 1/4" (6,35)	S Ø 8	D	R	B	L
A116.135.R	B116.135.R	C116.135.R	13,5	2	13	41
A116.150.R	B116.150.R	C116.150.R	15	2,8	13	42
A116.167.R	B116.167.R	C116.167.R	16,7	3,6	19	48
A116.222.R	B116.222.R	C116.222.R	22,2	5,2	19	48
A116.260.R Selling out		C116.260.R	26	6,8	25	54

T-SLOT HW CUTTERS Z=4

ART. C173

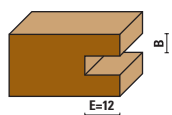
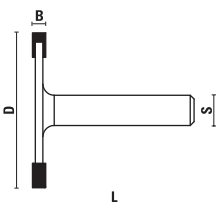

Four wings t-slot cutters for working wood, plastic material and aluminum

S Ø 8	D	B	L
C173.020.R	41	2	43
C173.025.R	41	2,5	43
C173.030.R	41	3	44
C173.035.R	41	3,5	44
C173.040.R	41	4	45
C173.045.R	41	4,5	45
C173.050.R	41	5	46

SLOT CUTTER ARBORS

ART. A117 - B117 - C117 - E117 - G117

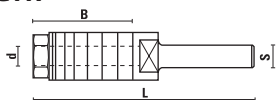

Used with cutters Art. A118 - C118, spacers Art. Z057 and ball bearing Art. Z050 (see section 10)



S Ø 6	S Ø 1/4" (6,35)	S Ø 8	d	B	L
A117.060.R	B117.060.R		6	17	52
A117.080.R	B117.080.R		7,94	34	67
		C117.060.R	6	17	57
		C117.079.R	7,94	34	70
		C117.080.N	7,94	53	96
		C117.081.N	7,94	66	102
		C117.082.N	7,94	38	74

S Ø 12	S Ø 12,7 (1/2")	d	B	L
E117.120.N	G117.120.R	7,94	53	96
E117.121.N	G117.121.R	7,94	66	108
E117.122.N	G117.122.R	7,94	38	80
E117.123.N	G117.123.R	7,94	38	80

HW SLOT CUTTERS Z=2

ART. A118

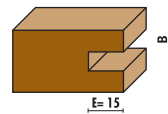
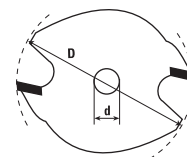

Bore Ø 6	d	D	B	Z
A118.015.R	6	40	1,5	2
A118.018.R	6	40	1,8	2
A118.020.R	6	40	2	2
A118.025.R	6	40	2,5	2
A118.030.R	6	40	3	2
A118.035.R	6	40	3,5	2
A118.040.R	6	40	4	2
A118.050.R	6	40	5	2
A118.060.R	6	40	6	2

HW SLOT CUTTERS Z=2

ART. C118

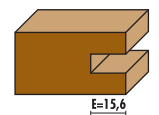
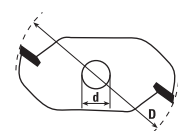

Item	d	D	B	Z
C118.216.R	7,94	47,6	1,6	2
C118.220.R	7,94	47,6	2	2
C118.224.R	7,94	47,6	2,4	2
C118.230.R	7,94	47,6	3	2
C118.232.R	7,94	47,6	3,2	2
C118.240.R	7,94	47,6	4	2
C118.248.R	7,94	47,6	4,8	2
C118.250.R	7,94	47,6	5	2
C118.260.R	7,94	47,6	6	2
C118.264.R	7,94	47,6	6,4	2

HW SLOT CUTTERS Z=3

ART. C118

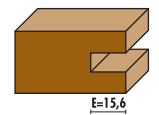
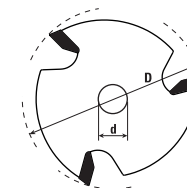

Item	d	D	B	Z
C118.316.R	7,94	47,6	1,6	3
C118.320.R	7,94	47,6	2	3
C118.324.R	7,94	47,6	2,4	3
C118.330.R	7,94	47,6	3	3
C118.332.R	7,94	47,6	3,2	3
C118.340.R	7,94	47,6	4	3
C118.348.R	7,94	47,6	4,8	3
C118.350.R	7,94	47,6	5	3
C118.360.R	7,94	47,6	6	3
C118.364.R	7,94	47,6	6,4	3

SLOT CUTTER ARBORS

ART. A117 - B117 - C117 - E117 - G117

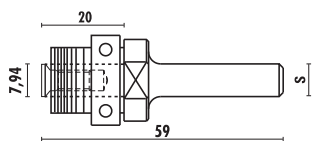

S Ø 6 **S Ø 1/4" (6,35)** **S Ø 8** **S Ø 12** **S Ø 1/2" (12,7)**

A117.280.R B117.280.R C117.280.R E117.280.R G117.280.R

With ball bearing



Z050.008.N



Z051.015.R



nr. 2 - Z057.002.N - 1 mm
nr. 2 - Z057.003.N - 0,5 mm
nr. 5 - Z057.004.N - 0,1 mm
nr. 2 - Z057.005.N - 3 mm

Change the ball bearing to get different cutting depths (see page 10.05)

S Ø 6 **S Ø 1/4" (6,35)** **S Ø 8** **S Ø 12** **S Ø 1/2" (12,7)**

A117.281.R B117.281.R C117.281.R E117.281.R G117.281.R

Without ball bearing



Z051.015.R



nr. 3 - Z057.002.N - 1 mm
nr. 2 - Z057.003.N - 0,5 mm
nr. 6 - Z057.004.N - 0,1 mm
nr. 2 - Z057.005.N - 3 mm
nr. 1 - Z057.006.N - 6 mm

HW SLOT CUTTERS SPECIAL FIXING SCREW Z=3

ART. C118

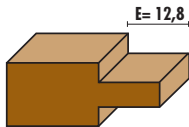
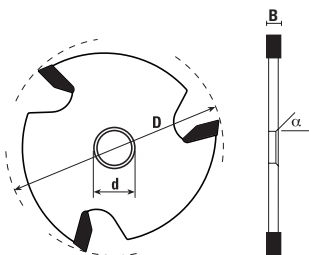

- To be used with slot cutter arbors
- $\alpha = 45^\circ$ bore



Item	d	D	B	Z
C118.830.R	7,94	47,6	3	3
C118.832.R	7,94	47,6	3,2	3
C118.840.R	7,94	47,6	4	3
C118.848.R	7,94	47,6	4,8	3
C118.850.R	7,94	47,6	5	3
C118.860.R	7,94	47,6	6	3
C118.864.R	7,94	47,6	6,4	3

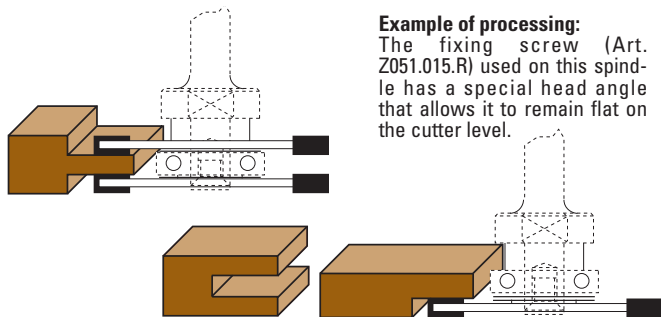

Example of processing:
The fixing screw (Art. Z051.015.R) used on this spindle has a special head angle that allows it to remain flat on the cutter level.

HW TRIMMING BITS WITH BALL BEARING Z=2

ART. A119 - B119 - C119

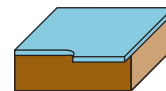
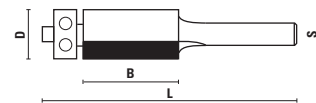

Ideal for working laminated panels

S Ø 6 **S Ø 1/4" (6,35)** **D** **B** **L**

A119.064.R B119.064.R 6,4 13 53



Z050.017.N



Z051.006.N

S Ø 6 **S Ø 1/4" (6,35)** **S Ø 8** **D** **B** **L**

A119.095.R B119.095.R C119.095.R 9,5 13 54



Z050.002.N



Z053.002.N



Z054.002.N



Z051.002.R

S Ø 6 **S Ø 1/4" (6,35)** **S Ø 8** **D** **B** **L**

A119.127.R B119.127.R C119.127.R 12,7 13 60



Z050.003.N



Z053.002.N



Z054.002.N



Z051.002.R

HW TRIMMING BITS WITH BALL BEARING Z=2

ART. A119 - B119 - C119

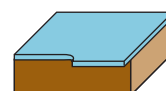
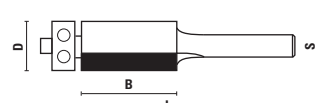

- Ideal for working laminated panels
- Shear angle cutting edge

S Ø 6 **S Ø 1/4" (6,35)** **S Ø 8** **D** **B** **L**

A119.160.R B119.160.R C119.160.R 16 16 56



Z050.004.N



Z053.004.N



Z054.002.N



Z051.002.R

S Ø 6 **S Ø 1/4" (6,35)** **S Ø 8** **D** **B** **L**

A119.190.R B119.190.R C119.190.R 19 16 60

A119.191.R B119.191.R C119.191.R 19 25 72



Z050.005.N



Z053.002.N



Z051.004.R



HW TRIMMING BITS WITH BALL BEARING Z=2

ART. A120 - B120 - C120

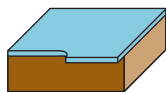
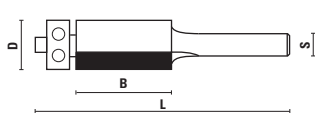

Ideal for working laminated panels

S Ø 6	S Ø 1/4" (6,35)	S Ø 8	D	B	L
A120.064.R	B120.064.R	C120.064.R	6,4	25	67



Z050.017.N

Z051.006.N

S Ø 6	S Ø 1/4" (6,35)	S Ø 8	D	B	L
A120.095.R	B120.095.R	C120.095.R	9,5	25	67



Z050.002.N

Z053.002.N

Z054.002.N

Z051.002.R

S Ø 6	S Ø 1/4" (6,35)	S Ø 8	D	B	L
A120.127.R	B120.127.R	C120.127.R	12,7	25	67



Z050.003.N

Z053.003.N

Z054.002.N

Z051.002.R

HW RABBETING BITS WITH BALL BEARING Z=2

ART. A121 - B121 - C121

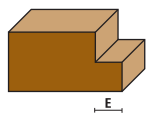
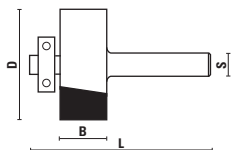

S Ø 6	S Ø 1/4" (6,35)	S Ø 8	D	B	E	L
A121.240.R	B121.240.R	C121.240.R	24	13	4	54



Z050.011.N

Z054.003.N

Z051.004.N

S Ø 6	S Ø 1/4" (6,35)	S Ø 8	D	B	E	L
A121.317.R	B121.317.R	C121.317.R	31,7	13	9,5	51
A121.350.R	B121.350.R	C121.350.R	35	13	11	51



Z050.003.N

Z053.003.N

Z054.002.N

Z051.002.R



ART. A122 - B122 - C122

HW RABBETING BITS WITH BALL BEARING Z=2

ART. A121 - B121 - C121

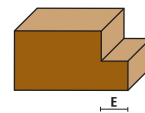
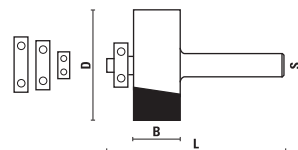

Supplied with nr. 4 ball bearings
in order to obtain E= 8 - 9,5 - 11 - 12,7

SET



S Ø 6	S Ø 1/4" (6,35)	S Ø 8	D	B	E	L
A121.850.R	B121.850.R	C121.850.R	35	13	8/9,5/11/12,7	51



E=8 Z050.023.N

E=9,5 Z050.022.N

E=11 Z050.003.N

E=12,7 Z050.002.N

Z051.002.R

HW BEVEL TRIM BITS WITH BALL BEARING Z=2

ART. A122 - B122

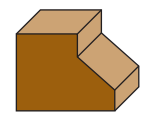
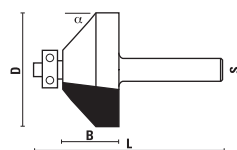

S Ø 6	S Ø 1/4" (6,35)	D	α	B	L
A122.350.R	B122.350.R	35	45°	18	57



Z050.003.N

Z053.003.N

Z054.002.N

Z051.002.R

HW BEVEL TRIM BITS WITH BALL BEARING GUIDE

ART. A122 - B122 - C122

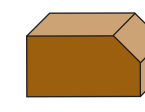
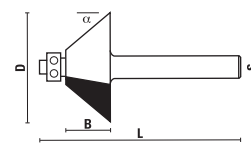

S Ø 6	S Ø 1/4" (6,35)	S Ø 8	D	α	B	L	Z
A122.010.R	B122.010.R	C122.010.R	17,5	10°	10	49	3
A122.015.R	B122.015.R	C122.015.R	19	15°	10	49	3
A122.025.R	B122.025.R	C122.025.R	22	25°	10	49	3
A122.045.R	B122.045.R	C122.045.R	30	45°	10	49	3



Z050.004.N

Z053.004.N

Z054.002.N

Z051.002.R

S Ø 6	S Ø 1/4" (6,35)	S Ø 8	D	α	B	L	Z
A122.130.R	B122.130.R	C122.130.R	13	15°	12,7	46	2
A122.190.R	B122.190.R	C122.190.R	19	25°	12,7	46	2
A122.317.R	B122.317.R	C122.317.R	31,7	45°	13	51	2



Z050.001.N

Z053.001.N

Z054.001.N

Z051.001.R

HW CORNER ROUNDING BITS WITH BALL BEARING Z=2

ART. A123 - B123 - C123

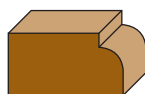
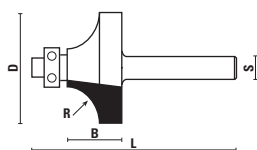

S Ø 6	S Ø 1/4" (6,35)	S Ø 8	D	R	B	L
A123.160.R	B123.160.R	C123.160.R	16	1,6	8	46
A123.167.R	B123.167.R	C123.167.R	16,7	2	8	47
A123.187.R		C123.187.R	18,7	3	9,5	49
A123.190.R	B123.190.R	C123.190.R	19	3,2	10	48
A123.207.R	B123.207.R	C123.207.R	20,7	4	10	49
A123.222.R	B123.222.R	C123.222.R	22,2	4,8	13	51
A123.227.R		C123.227.R	22,7	5	12	51
A123.247.R		C123.247.R	24,7	6	12	51
A123.254.R	B123.254.R	C123.254.R	25,4	6,4	13	51
A123.286.R	B123.286.R	C123.286.R	28,6	8	13	51
A123.318.R	B123.318.R	C123.318.R	31,8	9,5	16	56
A123.327.R		C123.327.R	32,7	10	16	55
A123.354.R	B123.354.R	C123.354.R	35,4	11	17	57
A123.367.R		C123.367.R	36,7	12	20	57
A123.380.R	B123.380.R	C123.380.R	38	12,7	19	57



Z050.003.N



Z053.003.N



Z054.002.N



Z051.002.R

Corner rounding bits sets in wooden case see page 1.29

HW CORNER ROUNDING BITS WITH DELRIN® BALL BEARING Z=2

ART. C323

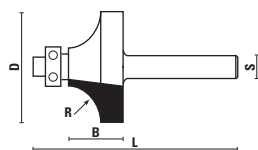

- Complete with Delrin® ball bearing to avoid marking and scratches
- Suitable for working composite material

S Ø 8	D	R	B	L
C323.167.R	16,7	2	8	47
C323.187.R	18,7	3	9,5	49
C323.190.R	19	3,2	10	48
C323.222.R	22,2	4,8	13	51
C323.254.R	25,4	6,4	13	51
C323.286.R	28,6	8	13	51
C323.318.R	31,8	9,5	16	56
C323.354.R	35,4	11	17	57
C323.380.R	38	12,7	19	57



Z050.100.N



Z054.002.N



Z051.002.R

HW BEADING BITS WITH BALL BEARING GUIDE Z=2

ART. A124 - B124 - C124

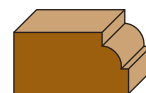
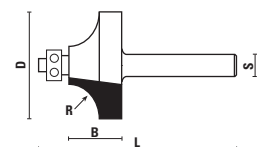

S Ø 6	S Ø 1/4" (6,35)	S Ø 8	D	R	B	L
A124.160.R	B124.160.R	C124.160.R	16	1,6	8	46
A124.167.R		C124.167.R	16,7	2	8	47
A124.187.R		C124.187.R	18,7	3	9,5	49
A124.190.R	B124.190.R	C124.190.R	19	3,2	10	48
A124.207.R	B124.207.R	C124.207.R	20,7	4	10	49
A124.222.R	B124.222.R	C124.222.R	22,2	4,8	13	51
A124.227.R		C124.227.R	22,7	5	12	51
A124.247.R		C124.247.R	24,7	6	12	51
A124.254.R	B124.254.R	C124.254.R	25,4	6,4	13	51
A124.286.R	B124.286.R	C124.286.R	28,6	8	13	51
A124.318.R	B124.318.R	C124.318.R	31,8	9,5	16	56
A124.327.R		C124.327.R	32,7	10	16	55
A124.367.R		C124.367.R	36,7	12	20	57
A124.380.R	B124.380.R	C124.380.R	38	12,7	19	57



Z050.002.N



Z053.002.N



Z054.002.N



Z051.002.R

HW COVE BITS WITH BALL BEARING GUIDE Z=2

ART. A125 - B125 - C125

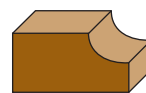
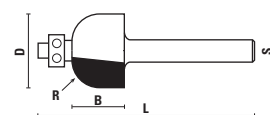

S Ø 6	S Ø 1/4" (6,35)	S Ø 8	D	R	B	L
A125.160.R	B125.160.R	C125.160.R	16	3,2	13	51
A125.190.R	B125.190.R	C125.190.R	19	4,8	14	51
A125.222.R	B125.222.R	C125.222.R	22,2	6,4	14	51
A125.254.R	B125.254.R	C125.254.R	25,4	8	14	51
A125.286.R	B125.286.R	C125.286.R	28,6	9,5	14	51
A125.350.R	B125.350.R	C125.350.R	35	12,7	16	54



Z050.001.N



Z053.001.N



Z054.001.N



Z051.001.R

HW DOUBLE FILLET COVE BITS WITH BALL BEARING GUIDE Z=2

ART. A126 - B126 - C126

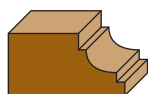
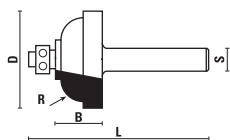

S Ø 6	S Ø 1/4" (6,35)	S Ø 8	D	R	B	L
A126.286.R	B126.286.R	C126.286.R	28,6	4,8	13	51
A126.350.R	B126.350.R	C126.350.R	35	8	16	54



Z050.003.N



Z053.003.N



Z054.002.N



Z051.002.R

HW ROMAN OGEE BITS WITH BALL BEARING GUIDE Z=2

ART. A127 - B127 - C127

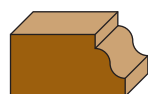
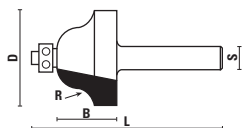

S Ø 6	S Ø 1/4" (6,35)	S Ø 8	D	R	B	L
A127.254.R	B127.254.R	C127.254.R	25,4	4	16	54
A127.350.R	B127.350.R	C127.350.R	35	6,4	20	57



Z050.001.N



Z053.001.N



Z054.001.N



Z051.001.R

HW DOUBLE ROMAN OGEE BITS Z=2

ART. A128 - B128 - C128

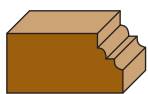
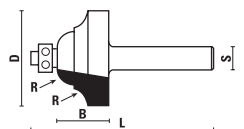

S Ø 6	S Ø 1/4" (6,35)	S Ø 8	D	R	B	L
A128.254.R	B128.254.R	C128.254.R	25,4	4	16	53
A128.350.R	B128.350.R	C128.350.R	35	6,4	20	57



Z050.001.N



Z053.001.N



Z054.001.N



Z051.001.R

HW OGEE BITS WITH BALL BEARING GUIDE Z=2

ART. A129 - B129 - C129 / A130 - B130 - C130

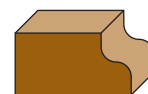
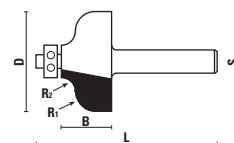

S Ø 6	S Ø 1/4" (6,35)	S Ø 8	D	R1	R2	B	L
A129.286.R	B129.286.R	C129.286.R	28,6	4,5	4	13	51
A129.350.R	B129.350.R	C129.350.R	35	6	5	18	55



Z050.003.N



Z053.003.N



Z054.002.N



Z051.002.R

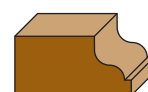

A130.286.R	B130.286.R	C130.286.R	28,6	4,5	4	13	51
A130.350.R	B130.350.R	C130.350.R	35	6	5	18	55



Z050.002.N



Z053.002.N



Z054.002.N



Z051.002.R

HW OGEE BITS WITH BALL BEARING GUIDE Z=2

ART. A131 - B131 - C131 / A132 - B132 - C132

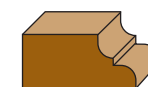
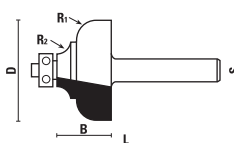

S Ø 6	S Ø 1/4" (6,35)	S Ø 8	D	R1	R2	B	L
A131.286.R	B131.286.R	C131.286.R	28,6	4	4	13	51
A131.350.R	B131.350.R	C131.350.R	35	6,4	4,8	18	56



Z050.003.N



Z053.003.N



Z054.002.N



Z051.002.R

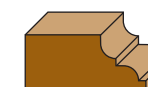

A132.286.R	B132.286.R	C132.286.R	28,6	4	4	13	51
A132.350.R	B132.350.R	C132.350.R	35	6,4	4,8	18	56



Z050.002.N



Z053.002.N



Z054.002.N



Z051.002.R

HW OGEE BITS WITH BALL BEARING GUIDE Z=2

ART. A133 - B133 - C133 / A134 - B134 - C134

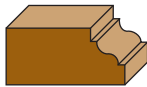
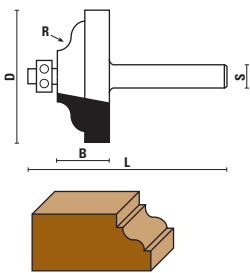

S Ø 6	S Ø 1/4" (6,35)	S Ø 8	D	R	B	L
A133.350.R	B133.350.R	C133.350.R	35	4	14	52
Z050.002.N	Z053.002.N	Z054.002.N	Z051.002.R			

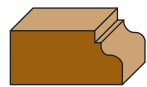

A134.350.R	B134.350.R	C134.350.R	D	R	B	L
			35	4	14	52
Z050.003.N	Z053.003.N	Z054.002.N	Z051.002.R			

HW CLASSICAL MOULDING BITS WITH BALL BEARING GUIDE Z=2

ART. A135 - B135 - C135 / A136 - B136 - C136

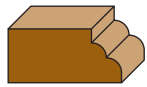
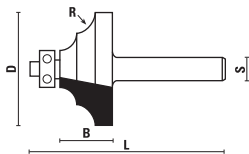

S Ø 6	S Ø 1/4" (6,35)	S Ø 8	D	R	B	L
A135.286.R	B135.286.R	C135.286.R	28,6	4	13	51
A135.350.R	B135.350.R	C135.350.R	35	5,5	18	60
Z050.003.N	Z053.003.N	Z054.002.N	Z051.002.R			



A136.286.R	B136.286.R	C136.286.R	D	R	B	L
			28,6	4	13	51
A136.350.R	B136.350.R	C136.350.R	35	5,5	18	60
Z050.002.N	Z053.002.N	Z054.002.N	Z051.002.R			

HW CORNER BEADING BITS WITH BALL BEARING GUIDE Z=2

ART. A137 - B137 - C137

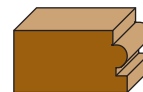
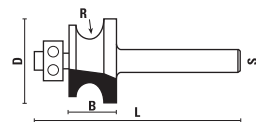

S Ø 6	S Ø 1/4" (6,35)	S Ø 8	D	R	B	L
A137.220.R	B137.220.R	C137.220.R	22	3,2	14	54
Z050.003.N	Z053.003.N	Z054.002.N	Z051.002.R			

S Ø 6	S Ø 1/4" (6,35)	S Ø 8	D	R	B	L
A137.280.R	B137.280.R	C137.280.R	28	4,8	16	57
A137.320.R	B137.320.R	C137.320.R	32	6,4	19	58
Z050.004.N	Z053.004.N	Z054.002.N	Z051.002.R			

HW EDGE-FLUTING BITS WITH BALL BEARING GUIDE Z=2

ART. A138 - B138

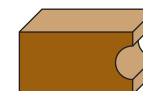
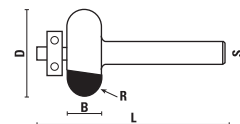

S Ø 6	S Ø 1/4" (6,35)	D	R	B	L
A138.210.R	B138.210.R	21	4	8	47
A138.230.R	B138.230.R	23	5	10	49
A138.250.R	B138.250.R	25	6	12	51
Z050.003.N	Z053.003.N	Z054.002.N	Z051.002.R		

HW MULTI-BEADING BITS WITH BALL BEARING GUIDE Z=2

ART. B139

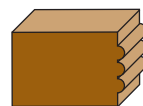
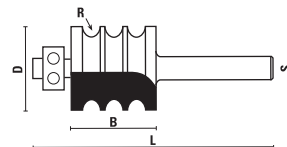

S Ø 1/4" (6,35)	D	R	B	L
B139.220.R*	22	3	25	65
Z050.004.N	Z053.004.N	Z054.002.N	Z051.002.R	

* Selling out

HW FLUSH-TRIM "V" GROOVE BITS WITH BALL BEARING GUIDE Z=2

ART. A141 - B141

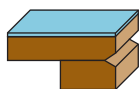
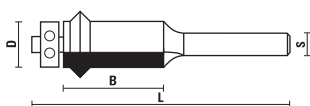

- Ideal for working laminated and melamine panels
- V-decor along the joints of the two wood pieces



S Ø 6	S Ø 1/4" (6,35)	D	B	L
A141.127.R	B141.127.R	12,7	25,4	67



Z050.003.N



Z053.003.N



Z054.002.N



Z051.002.R

HW FLAT ROUNDING OVER BITS WITH BALL BEARING GUIDE Z=2

ART. A142 - B142

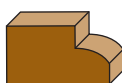
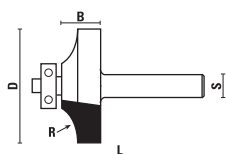

S Ø 6	S Ø 1/4" (6,35)	D	R	B	L
A142.300.R	B142.300.R	30	12	10	48



Z050.003.N



Z053.003.N



Z054.002.N



Z051.002.R

HW FLAT ROUNDING OVER BITS WITH BALL BEARING GUIDE Z=2

ART. A143 - B143

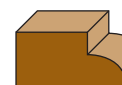
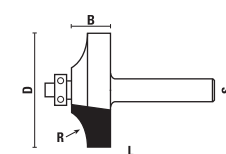

S Ø 6	S Ø 1/4" (6,35)	D	R	B	L
A143.300.R	B143.300.R	30	12	10	48



Z050.002.N



Z053.002.N



Z054.002.N



Z051.002.R

HW PROFILE BITS WITH BALL BEARING GUIDE

ART. A144 - B144

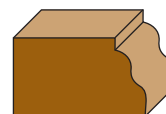
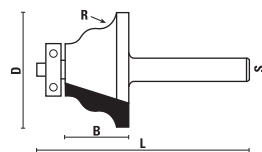

S Ø 6	S Ø 1/4" (6,35)	D	R	B	L
A144.318.R	B144.318.R	31,8	4	17,5	57



Z050.003.N



Z053.003.N



Z054.002.N



Z051.002.R

HW FLAT OGEE BITS WITH BALL BEARING GUIDE Z=2

ART. A145 - C145

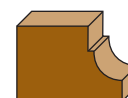
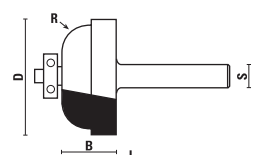

S Ø 6	S Ø 8	D	R	B	L
A145.286.R*	C145.286.R	28,6	4,8	13	51
A145.350.R*	C145.350.R	35	8	16	55

* Selling out



Z050.003.N



Z053.003.N



Z054.002.N



Z051.002.R

HW OVOLO JOINT BITS WITH BALL BEARING GUIDE Z=2

ART. A146 - C146

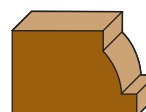
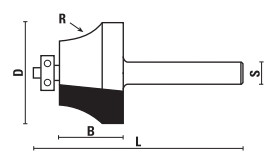

S Ø 6	S Ø 8	D	R	B	L
A146.270.R		27	17	17	57
A146.335.R*	C146.335.R*	33,5	9	15	57

* Selling out



Z050.002.N



Z053.002.N



Z054.002.N



Z051.002.R

HW OGEE BITS WITH BALL BEARING GUIDE Z=2

ART. A147 - B147 - C147

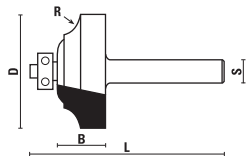

S Ø 6	S Ø 1/4" (6,35)	S Ø 8	D	R	B	L
A147.318.R*		C147.318.R*	31,8	5	13	51
A147.380.R	B147.380.R		38	6	16	54

* Selling out



Z050.003.N



Z053.003.N



Z054.002.N



Z051.002.R

HW PANEL PILOT BITS WITH BALL BEARING GUIDE Z=1

ART. A150 - C150

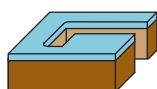
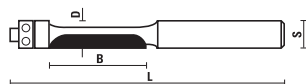

Ideal for working laminated panels

S Ø 6	S Ø 8	D	B	L
A150.064.R	C150.064.R	6,4	19	57



Z050.017.N

HW FLUSH AND BEVEL TRIM BITS Z=2

ART. A151 - C151

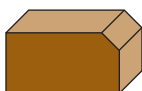
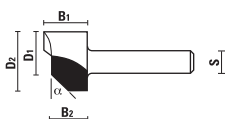

S Ø 6	S Ø 8	D1	D2	B1	B2	α
A151.200.R	C151.200.R	20	24	15	11	0°/45°

HW FINGER GRIP BITS Z=2

ART. A155

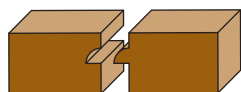
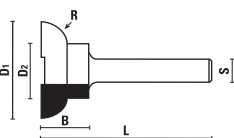
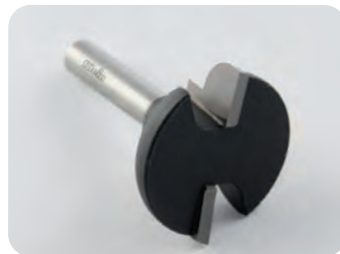

S Ø 6	D1	D2	R	B	L
A155.280.R	28	15	6,4	13	41

HW FLUSH AND BEVEL TRIM BITS WITH BALL BEARING GUIDE Z=2

ART. A152 - C152

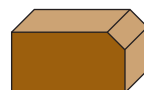
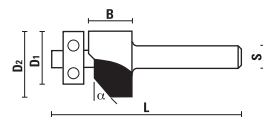

S Ø 6	S Ø 8	D1	D2	B	L	α
A152.190.R	C152.190.R	19	26	15	53	0°/45°



Z050.006.N

HW KEYHOLE BITS (T-SLOT)

ART. A153 - B153 - C153

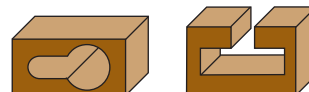
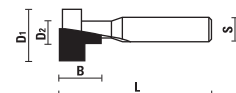

S Ø 6	S Ø 1/4" (6,35)	S Ø 8	D1	D2	B	L	Z
A153.098.R	B153.098.R	C153.098.R	9,8	5	9,8	38,1	1
A153.127.R	B153.127.R	C153.127.R	12,7	8	9,8	38,1	1
		C153.135.R NEW	13,5	8,6	14	52	2



Single flute cutters specifically made for making keyhole slots (smaller T-slots) in picture frames and other wall hanging wood products. Use the plunge tip for the first working step. Use on hand held, table mounted portable router and CNC routers.

HW CONVEX EDGING BITS Z=2

ART. A154 - C154

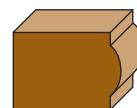
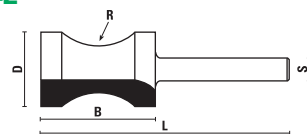

S Ø 6	S Ø 8	D	R	B	L
A154.202.R*	C154.202.R	20,2	18	32	62,6

* Selling out

HW DRAWER LOCK BITS Z=2

ART. A156

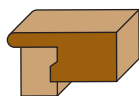
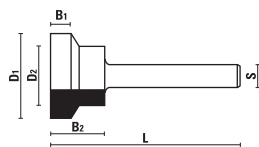
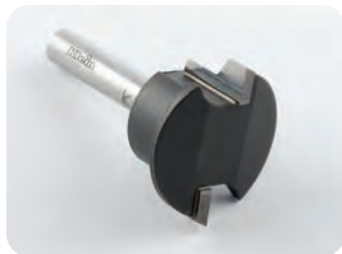

S Ø 6	D1	D2	B1	B2	L
A156.254.R	25,4	18,5	4	13	49

HW SEAL PROFILE BITS Z=2

ART. A157 - B157

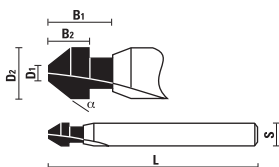

S Ø 6	S Ø 1/4" (6,35)	D1	D2	α	B1	B2	L
A157.055.R	B157.055.R	2	5,5	38°	8	4	65

HW DOVETAIL SEAL BITS Z=2

ART. A158 - B158

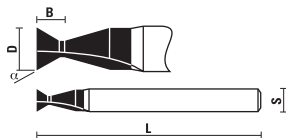

S Ø 6	S Ø 1/4" (6,35)	D	α	B	L
A158.051.R	B158.051.R	5,1	25°	4	60

HW SEAL BITS Z=2

ART. A159 - B159

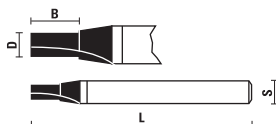

S Ø 6	S Ø 1/4" (6,35)	D	B	L
A159.030.R	B159.030.R	3	8	55

HW FLUSH TRIM BITS WITH UPPER BALL BEARING GUIDE Z=2

ART. A160 - B160 - C160

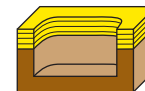
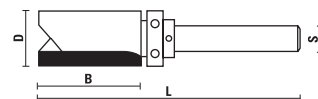

- Suitable for trimming and milling on every type of wood

S Ø 6	S Ø 1/4" (6,35)	D	B	L
A160.125.R	B160.125.R	12,7	13	55
A160.126.R	B160.126.R	12,7	19	55
A160.127.R	B160.127.R	12,7	25,4	63
A160.128.R	B160.128.R	12,7	32	69



S Ø 6	S Ø 1/4" (6,35)	D	B	L
A160.160.R	B160.160.R	16	25,4	63



S Ø 8	D	B	L
C160.161.R	16	32	69



S Ø 6	S Ø 1/4" (6,35)	D	B	L
A160.190.R	B160.190.R	19	25,4	63



HW "MINI" FLUSH TRIM BITS WITH UPPER BALL BEARING GUIDE Z=2

ART. A160 - C160

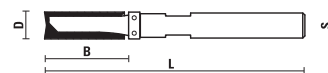

- Suitable for trimming and milling on every type of wood
- Specially designed for small fine work because can fit into tight spaces and corners
- Perfect for guitar makers



S Ø 6	S Ø 8	D	B	L
A160.048.R NEW		4,8	12	51
A160.064.R NEW		6,4	19	62
	C160.080.R NEW	8	19	62



HW FLUSH TRIM BITS WITH UPPER BALL BEARING GUIDE Z=2

ART. A161 - B161

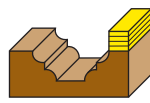
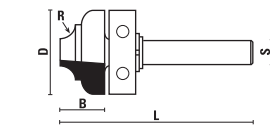

S	Ø 6	S	Ø 1/4" (6,35)	D	R	B	L
A161.220.R		B161.220.R		22	3,5	11	51

ART. A162 - B162

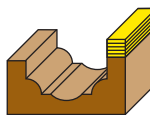
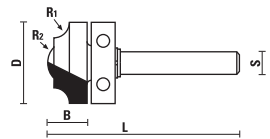

S	Ø 6	S	Ø 1/4" (6,35)	D	R1	R2	B	L
A162.220.R		B162.220.R		22	4	5,5	12	51



Z050.008.N



DIN 471-15

HW FLUSH TRIM BITS WITH UPPER BALL BEARING GUIDE Z=2

ART. A163 - B163

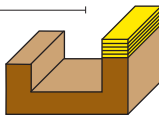
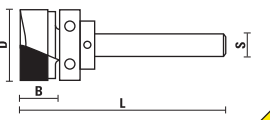

If shank Ø8 mm is needed, use bushings Art. Z001 see page 10.03

S	Ø 6	S	Ø 1/4" (6,35)	D	B	L
A163.190.R		B163.190.R		19	11	56



Z050.005.N



Z058.001.N



Z051.005.R

HW GROOVE BITS WITH UPPER BALL BEARING GUIDE Z=2

ART. A164 - B164

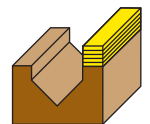
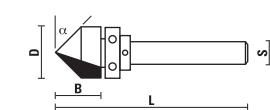

S	Ø 6	S	Ø 1/4" (6,35)	D	α	B	L
A164.127.R		B164.127.R		12,7	45°	13	51



Z050.007.N



Z058.001.N



Z052.005.N



Z051.005.R

HW CORE BOX BITS WITH UPPER BALL BEARING GUIDE Z=2

ART. A165 - B165 - C165

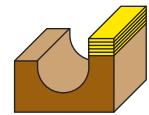
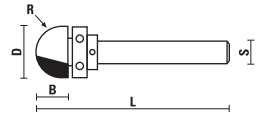

Suitable for cutting round-bottom groove that can be both decorative and functional on every type of wood.



S	Ø 6	S	Ø 1/4" (6,35)	D	R	B	L
A165.127.R		B165.127.R		12,7	6,4	9,5	51



Z050.007.N



Z058.001.N



Z051.005.R

S	Ø 6	S	Ø 8	D	R	B	L
A165.160.R			C165.160.R	16	8	11	54



Z050.018.N



Z058.004.N



Z051.005.R

S	Ø 6	D	R	B	L
A165.190.R		19	9,5	11	54



Z050.006.N



Z058.005.N



Z051.005.R

S	Ø 8	D	R	B	L
	C165.190.R	19	9,5	11	54



Z050.026.N



Z058.006.N



Z051.005.R

HW BOWL AND TRAY BITS WITH UPPER BALL BEARING GUIDE Z=2

ART. A166 - B166 - C166

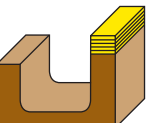
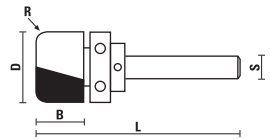

Suitable for making custom bowls, boxes, plates in any shape you can cut template for



S	Ø 6	S	Ø 1/4" (6,35)	D	R	B	L
A166.127.R		B166.127.R		12,7	3,2	13	54



Z050.007.N



Z058.001.N



Z051.005.R

S	Ø 6	S	Ø 1/4" (6,35)	D	R	B	L
A166.190.R		B166.190.R		19	6,4	16	59



Z050.005.N



Z058.001.N



Z051.005.R

S	Ø 8	D	R	B	L
	C166.190.R	19	6,4	16	67



Z050.026.N



Z058.006.N



Z051.005.R

HW FLUSH TRIM BITS WITH UPPER BALL BEARING GUIDE Z=2

ART. A167 - B167

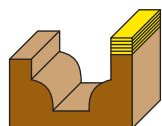
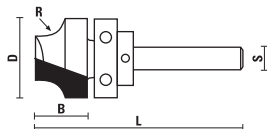

S Ø 6	S Ø 1/4" (6,35)	D	R	B	L
-------	-----------------	---	---	---	---

A167.127.R B167.127.R 12,7 3 9,5 48



Z050.007.N



Z058.001.N



Z051.005.R

S Ø 6	S Ø 1/4" (6,35)	D	R	B	L
-------	-----------------	---	---	---	---

A167.220.R B167.220.R 22 5 12 55



Z050.008.N



Z058.001.N



Z051.005.R

S Ø 6	D	R	B	L
-------	---	---	---	---

A167.286.R 28,6 8 15 58



Z050.015.N



Z058.003.N



Z051.005.R

HW "LEAF-EDGE" BEADING BITS WITH DOUBLE BALL BEARING GUIDE Z=2

ART. A168 - B168

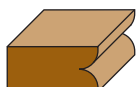
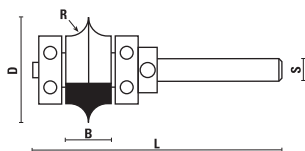

S Ø 6	S Ø 1/4" (6,35)	D	R	B	L
-------	-----------------	---	---	---	---

A168.254.R B168.254.R 25,4 4,8 13 66



Z050.011.N



Z058.001.N



Z053.002.N



Z051.004.R



Z051.005.R

HW "EDGE-FLUTING" BITS WITH DOUBLE BALL BEARING GUIDE Z=2

ART. A169 - B169

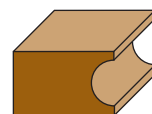
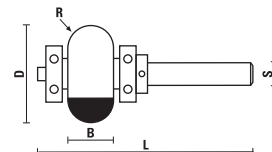

S Ø 6	S Ø 1/4" (6,35)	D	R	B	L
-------	-----------------	---	---	---	---

A169.230.R B169.230.R 23 5 10 61



Z050.007.N superiore



Z058.001.N

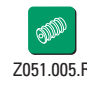

Z051.005.R



Z050.003.N inferiore



Z053.003.N

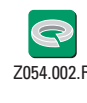

Z054.002.R



Z051.002.R

HW RADIUS BITS WITH DOUBLE BALL BEARING GUIDE Z=2

ART. A170 - C170

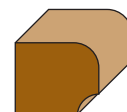
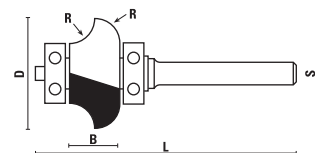

Patent

S Ø 6	S Ø 8	D	R	B	L
-------	-------	---	---	---	---

A170.285.R* C170.285.R* 28,5 6,4 14 66

A170.320.R* C170.320.R* 32 8 17 69

A170.350.R* C170.350.R* 35 9,5 20 72

* Selling out



Z050.018.N



Z058.001.N



Z051.005.R

HW DOUBLE DIAMETER BITS Z=2

ART. A180 - B180

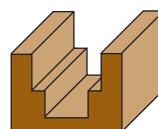
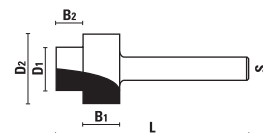

S Ø 6	S Ø 1/4" (6,35)	D1	D2	B1	B2	L
-------	-----------------	----	----	----	----	---

A180.127.R B180.127.R 12,7 19 9,5 6,4 51

HW DOUBLE RADIUS BITS Z=2

ART. A181 - C181

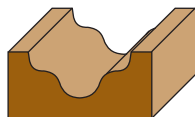
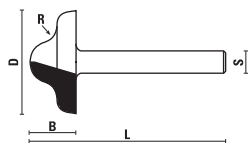

S Ø6	S Ø8	D	R	B	L
A181.270.R*	C181.270.R	27	6	12	52

* Selling out

HW DOUBLE RADIUS BITS Z=2

ART. A182 - C182

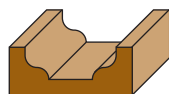
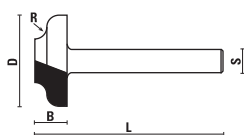

S Ø6	S Ø8	D	R	B	L
A182.254.R*	C182.254.R	25,4	3,2	9,5	50

* Selling out

HW DOUBLE RADIUS BITS Z=2

ART. A185

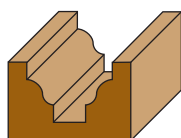
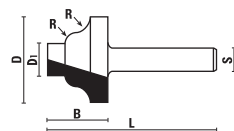

S Ø6	D	D ₁	R	B	L
A185.210.R*	21	8	3,2	13	42
A185.250.R*	25	8	4	17	45

* Selling out

HW DOUBLE RADIUS BITS Z=2

ART. A186 - B186

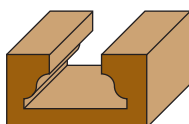
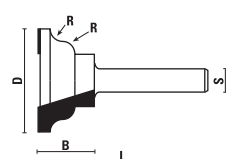

S Ø6	S Ø1/4" (6,35)	D	D ₁	R	B	L
A186.250.R	B186.250.R	25	12	3,2	13	42
A186.290.R*		29	12	4	17	45

* Selling out

HW MULTI RADIUS BITS Z=2

ART. A191

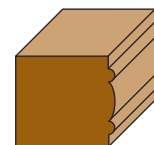
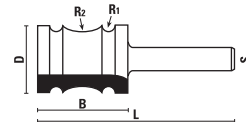

S Ø6	D	R1	R2	B	L
A191.190.R	19	2	6	25	55

HW 45 DEGREE LOCK MITRE JOINT BITS Z=2

ART. A195 - B195

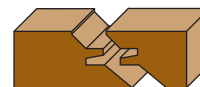
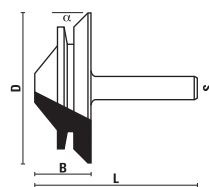

S Ø6	S Ø1/4" (6,35)	D	α	B	L
A195.420.R	B195.420.R	42	45°	16	45

HW BOWL AND TRAY BITS Z=2

ART. A196 - B196 - C196

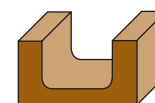
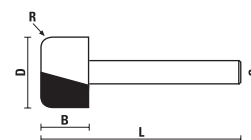

Suitable for cutting hollows into bowls, boxes, plates, serving trays and spoon



S Ø6	S Ø1/4" (6,35)	S Ø8	D	R	B	L
		C196.110.R	11	3	12,7	54
A196.190.R	B196.190.R	C196.190.R	19	6,4	16	60



HW ADJUSTABLE COUNTERSINKS Z=2

ART. A199

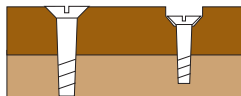
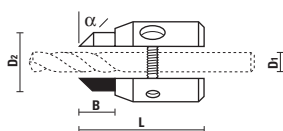

Spare key supplied; single packed

Item	D1	D2	α	B	L
A199.030.R	3/7	11/15	45°	12	32
A199.060.R	6/10	15,5/19,5	45°	12	34

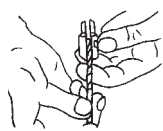

Insert the tool



Adjust the boring depth

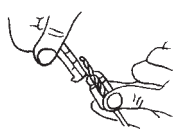

Line up the cutting edges of countersink and tool



Tighten the screws

HS FLUSH TRIMMERS FOR TABLE EDGE BANDING MACHINES

ART. AG

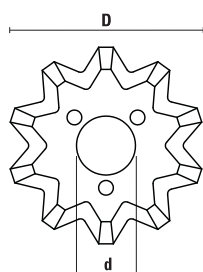

To be used on "VITAP" machines

Item	D	d	B	Z
AG040.01012	40	12	1,1	10

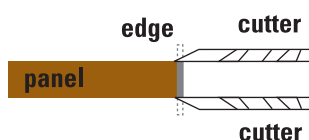

HW BORING BITS

ART. C192

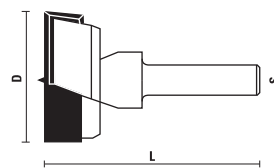

Without spurs

S Ø 8	D	L
C192.250.R	25	57
C192.260.R	26	57
C192.300.R	30	57
C192.350.R	35	57

BUSHINGS

ART. Z001

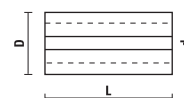

Item	D	d	L	Item	D	d	L
Z001.001.N	8	6	25	Z001.006.N	12	6	25
Z001.002.N	9,5	6	25	Z001.007.N	12	10	25
Z001.003.N	9,5	8	25	Z001.008.N	16	13	40
Z001.004.N	10	8	25	Z001.009.N	8	6,4	25
Z001.005.N	12	8	25	Z001.010.N	12	9,5	25
Z001.006.N	12	6	25	Z001.011.N	10	6	25
Z001.009.N	8	6,4	25	Z001.012.N	8	5	25
Z001.011.N	10	6	25	Z001.013.N	8	4	25
Z001.017.N	9,5	6,4	25	Z001.014.N	8	3	25
Z001.019.N	12,7	8	25	Z001.015.N	10	5	25
Z001.020.N	12,7	6,4	25	Z001.016.N	10	4	25
Z001.001.N	8	6	25	Z001.017.N	9,5	6,4	25
Z001.002.N	9,5	6	25	Z001.018.N	12,7	9,5	25
Z001.003.N	9,5	8	25	Z001.019.N	12,7	8	25
Z001.004.N	10	8	25	Z001.020.N	12,7	6,4	25
Z001.005.N	12	8	25				

SPACERS

ART. Z057

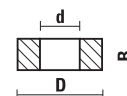

Item	D	d	B
Z057.001.N	16	7,94	3,6
Z057.002.N	16	7,94	1
Z057.003.N	16	7,94	0,5
Z057.004.N	16	7,94	0,1
Z057.005.N	16	7,94	3
Z057.006.N	16	7,94	6
Z057.007.N	16	7,94	0,4
Z057.008.N	16	7,94	0,05
Z057.009.N	16	7,94	5,3
Z057.010.N	9,5	6,4	2,2
Z057.101.N	10	6	1
Z057.102.N	10	6	1,5
Z057.103.N	10	6	3

INSERT ROUTER BITS FOR PORTABLE ROUTERS

Always looking for innovative products and most useful solutions, **SISTEMI** has developed a new line of **Klein** router bits with interchangeable carbide knives, which have a higher hardness than the tips used in traditional brazed router bits. The main advantages granted by the use of HW reversible knives and the possibility of their easy replacement are:

- Longer tool life
- Better Quality/Price ratio
- Better finish quality
- Environmental friendly
- Higher measures precision

HW INSERT FLUSH TRIMMING BITS Z=1

ART. WC101

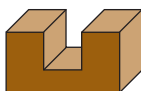
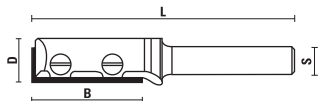

Complete with reversible knives



S Ø 8	D	B	L
WC101.120.R	12	29,5	66
Z055.330.N	Z051.501.R		

HW INSERT V-GROOVING BITS Z=1

ART. WC109

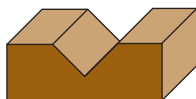
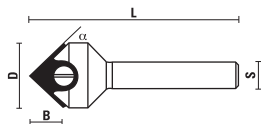

Complete with reversible knives



S Ø 8	D	B	α	L
WC109.176.R	17,6	8,5	45°	53
Z055.001.N	Z051.501.R			

HW INSERT CORE BOX BITS WITH UPPER BALL BEARING Z=1

ART. WC111

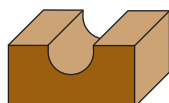
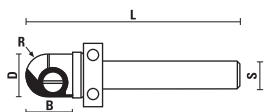

Complete with reversible knives



S Ø 8	D	B	R	L
WC111.127.R	12,7	13	6	59
Z050.018.N	Z055.550.N	Z051.501.R		

HW INSERT FLUSH TRIMMING BITS WITH BALL BEARING

ART. WC120

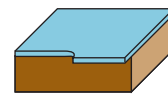
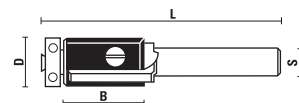

Complete with reversible knives



S Ø 8	D	B	L	Z
WC120.127.R	12,7	20	62	2
Z050.003.N	Z055.551.N	Z051.503.N Screw for ball bearing	Z051.501.R Screw for knives	

HW INSERT RABBIT BITS WITH BALL BEARING Z=2

ART. WC121

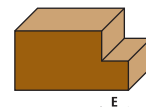
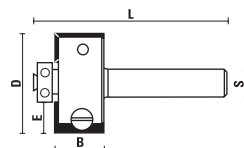

Complete with reversible knives



S Ø 8	D	B	E	L
WC121.286.R	28,6	13,2	7,95	48
Z050.002.N	Z055.552.N	Z051.503.N Screw for ball bearing	Z051.501.R Screw for knives	

HW INSERT FLUSH TRIMMING BITS WITH BALL BEARING Z=2

ART. WC122

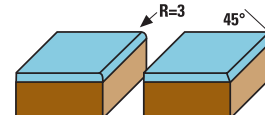
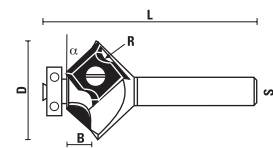

- Complete with reversible knives

- The same knives can be used for both 45° and R= 3 bevel



S Ø 8	D	B	R	α	L
WC122.273.R	27,3	5,7	3	45°	59
Z050.003.N	Z055.553.N	Z051.503.N Screw for ball bearing	Z051.501.R Screw for knives		

HW INSERT CORNER ROUNDING BITS WITH BALL BEARING Z=2

ART. WC123

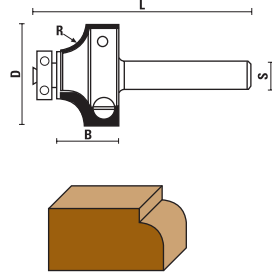

Complete with reversible knives



S Ø 8	D	B	R	L
WC123.260.R	26	15,7	6	55
Z050.003.N	Z055.554.N	Z051.503.N	Z051.501.R	Screw for ball bearing Screw for knives

HW INSERT COVER BITS WITH BALL BEARING Z=2

ART. WC125

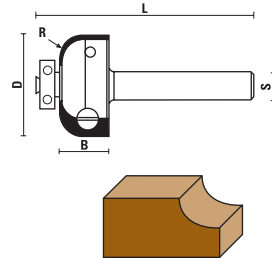

Complete with reversible knives



S Ø 8	D	B	R	L
WC125.260.R	26	12,7	6	55
Z050.003.N	Z055.555.N	Z051.503.N	Z051.501.R	Screw for ball bearing Screw for knives

HW INSERT OGEE BITS WITH BALL BEARING Z=2

ART. WC129

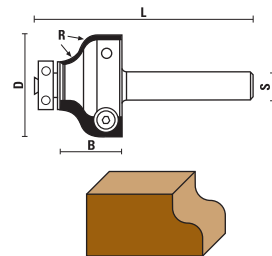

Complete with reversible knives



S Ø 8	D	B	R	L
WC129.260.R	26	15,7	4,5	55
Z050.003.N	Z055.556.N	Z051.503.N	Z051.501.R	Screw for ball bearing Screw for knives

HW INSERT FLUSH TRIMMING BITS Z=2

ART. W113

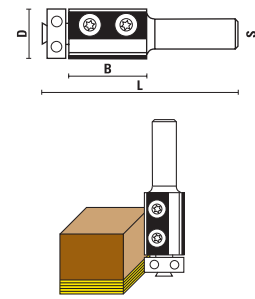

- Lower ball bearing
- This item is sold complete with a torx key



S Ø 8	D	B	L	Z	
W113.160.R	16	30	70	2	
W113.190.R	19	30	70	2	
Z555.008.N	Z050.004.N (D=16)	Z050.006.N (D=19)	Z052.201.N	Z051.017.R (for ball bearing)	Z051.010.R (for knives)

HW INSERT FLUSH TRIMMING BITS Z=2

ART. W115

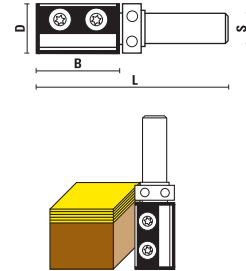

- Upper ball bearing
- This item is sold complete with a torx key



S Ø 8	D	B	L	Z
W115.190.R	19	30	70	2
Z555.008.N	Z050.012.N	Z052.201.N	Z051.017.R (for ball bearing)	Z051.010.R (for knives)

HW INSERT FLUSH TRIMMING BITS WITH UPPER ANF LOWER BALL BEARINGS Z=2

ART. W117

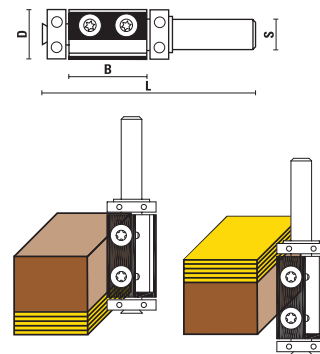

- Suitable for trimming with template on the upper and/or lower side
- This item is sold complete with a torx key



S Ø 8	D	B	L		
W117.190.R	19	30	85		
Z555.008.N	Z050.006.N (lower ball bearing)	Z050.012.N (upper ball bearing)	Z052.201.N	Z051.017.R (for ball bearing)	Z051.010.R (for knives)

6 PIECE STRAIGHT-DOVETAIL INSERT ROUTER BITS "STARTER SET"

ART. X001



- Set including the 6 most popular T.C.T. router bits in a robust and practical wooden box.
- Ideal to have always on hand the right bit for straight cuts, trimming and engraving.

S Ø 6	S Ø 1/4" (6,35)	S Ø 8
X001.006.R	X001.064.R	X001.008.R
6-pcs router bit set:	6-pcs router bit set:	6-pcs router bit set:
A101.060.R	B101.064.R	C101.060.R
A101.160.R	B101.160.R	C101.160.R
A105.064.R	B105.064.R	C105.064.R
A108.127.R	B108.127.R	C108.127.R
A109.127.R	B109.127.R	C109.127.R
A119.127.R	B119.127.R	C119.127.R

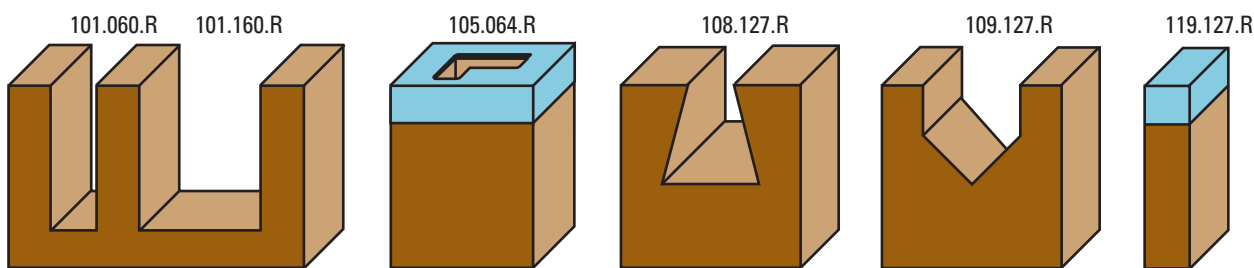

Scale 1:1

6 PIECE PROFILE ROUTER BITS "STARTER SET"

ART. X002



- Set including the 6 most popular T.C.T. router bits in a robust and practical wooden box.
- Ideal to have always on hand the right bit for straight cuts, trimming and profiling.

S Ø 6	S Ø 1/4" (6,35)	S Ø 8
X002.006.R	X002.064.R	X002.008.R
6-pcs router bit set:	6-pcs router bit set:	6-pcs router bit set:
A101.060.R	B101.064.R	C101.060.R
A119.127.R	B119.127.R	C119.127.R
A122.317.R	B122.317.R	C122.317.R
A123.254.R	B123.254.R	C123.254.R
A125.254.R	B125.254.R	C125.254.R
A127.254.R	B127.254.R	C127.254.R

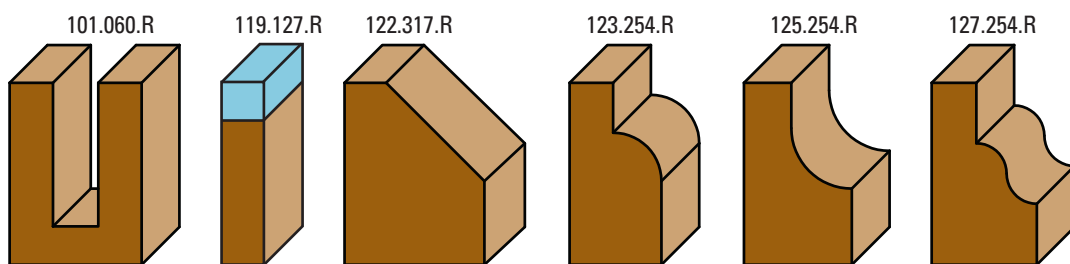

Scale 1:1

6 PIECE STRAIGHT BITS "STARTER SET"

ART. X003



- Set including the 6 most popular T.C.T. router bits in a robust and practical wooden box.
- Ideal to have always on hand the right bit for straight cuts.

S Ø 6	S Ø 1/4" (6,35)	S Ø 8
X003.006.R	X003.064.R	X003.008.R
6-pcs router bit set:	6-pcs router bit set:	6-pcs router bit set:
A101.030.R	B101.030.R	C101.030.R
A101.040.R	B101.040.R	C101.040.R
A101.060.R	B101.060.R	C101.060.R
A101.080.R	B101.080.R	C101.080.R
A103.100.R	B103.100.R	C103.100.R
A103.120.R	B103.120.R	C103.120.R

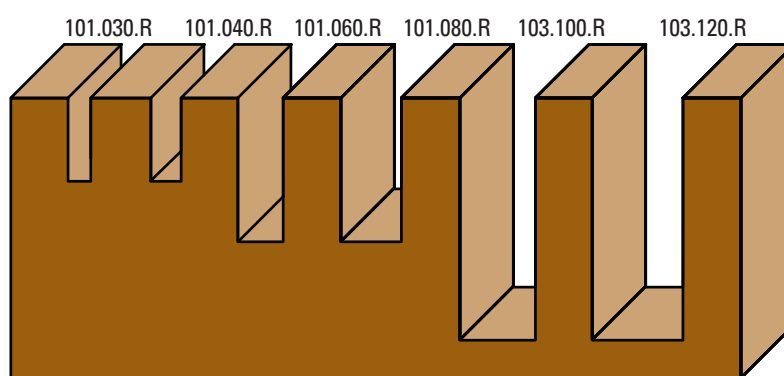

Scale 1:1

6 PIECE CORNER ROUNDING BITS "STARTER SET"

ART. X011



- Set including the 6 most popular T.C.T. router bits in a robust and practical wooden box.
- Ideal to have always on hand the right bit to produce corner roundings.

S Ø 6	S Ø 1/4" (6,35)	S Ø 8
X011.006.R	X011.064.R	X011.008.R
6-pcs router bit set:	6-pcs router bit set:	6-pcs router bit set:
A123.167.R	B123.167.R	C123.167.R
A123.187.R	B123.187.R	C123.187.R
A123.207.R	B123.207.R	C123.207.R
A123.227.R	B123.227.R	C123.227.R
A123.247.R	B123.247.R	C123.247.R
A123.286.R	B123.286.R	C123.286.R

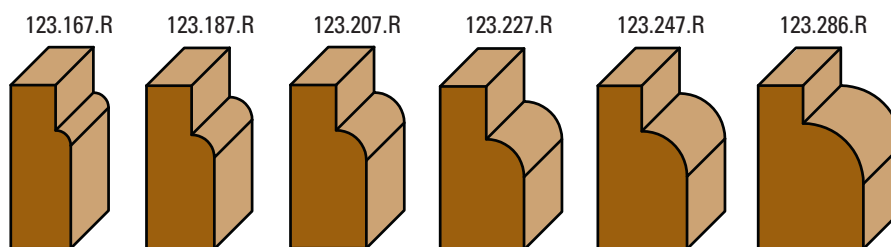

Scale 1:1

6 PIECE DOVETAIL BITS "STARTER SET"

ART. X012



- Set including the 6 most popular T.C.T. router bits in a robust and practical wooden box.
- Ideal to have the right bit for straight cuts and dovetail joints.

S Ø 6	S Ø 1/4" (6,35)	S Ø 8
X012.006.R	X012.064.R	X012.008.R
6-pcs router bit set:	6-pcs router bit set:	6-pcs router bit set:
A101.060.R	B101.060.R	C101.060.R
A102.080.R	B102.080.R	C102.080.R
A108.064.R	B108.064.R	C108.064.R
A108.095.R	B108.095.R	C108.095.R
A108.150.R	B108.150.R	C108.150.R
A108.190.R	B108.190.R	C108.190.R

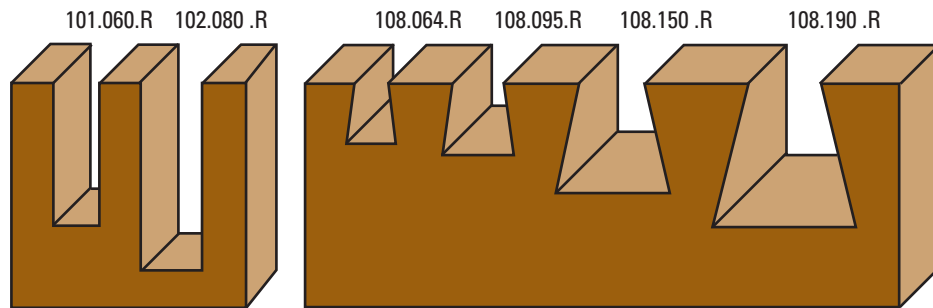

Scale 1:1

12 PIECE CLASSICAL ROUTER BITS "STARTER SET"

ART. X005



- Set including the 12 most popular T.C.T. router bits in a robust and practical wooden box.
- Ideal to have always on hand the right bit for straight cuts, trimming, engraving and profiling.

S Ø 6	S Ø 1/4" (6,35)	S Ø 8
X005.006.R	X005.064.R	X005.008.R
12-pcs router bit set:	12-pcs router bit set:	12-pcs router bit set:
A101.060.R	B101.064.R	C101.060.R
A101.120.R	B101.127.R	C101.120.R
A101.200.R	B101.190.R	C101.200.R
A105.064.R	B105.064.R	C105.064.R
A108.127.R	B108.127.R	C108.127.R
A109.127.R	B109.127.R	C109.127.R
A111.127.R	B111.127.R	C111.127.R
A119.127.R	B119.127.R	C119.127.R
A122.317.R	B122.317.R	C122.317.R
A123.254.R	B123.254.R	C123.254.R
A125.254.R	B125.254.R	C125.254.R
A127.254.R	B127.254.R	C127.254.R

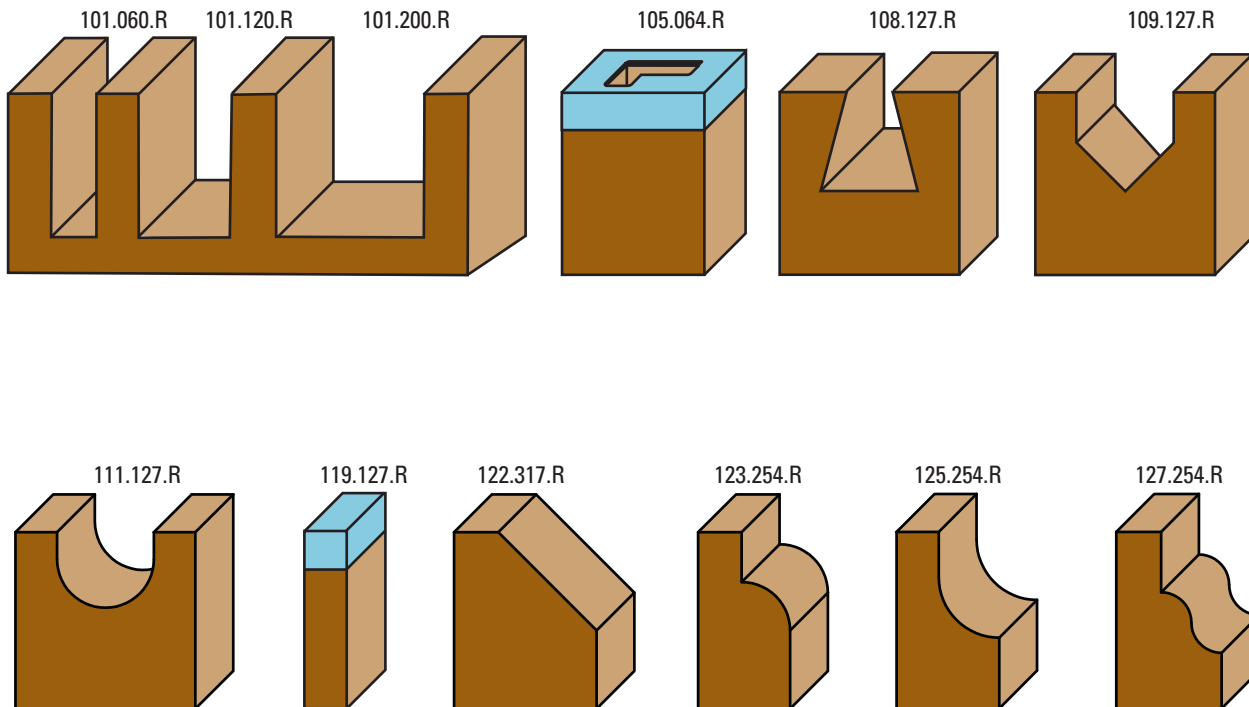

Scale 1:1

12 PIECE STRAIGHT BITS "ADVANCED SET"

ART. X006



- Set including the 12 most popular T.C.T. router bits in a robust and practical wooden box.
- Ideal to have always on hand the right bit for straight cuts.

S Ø 6	S Ø 1/4" (6,35)	S Ø 8
X006.006.R	X006.064.R	X006.008.R
12-pcs router bit set:	12-pcs router bit set:	12-pcs router bit set:
A101.030.R	B101.030.R	C101.030.R
A101.040.R	B101.040.R	C101.040.R
A101.060.R	B101.060.R	C101.060.R
A101.080.R	B101.080.R	C101.080.R
A101.100.R	B101.100.R	C101.100.R
A101.120.R	B101.120.R	C101.120.R
A102.060.R	B102.060.R	C102.060.R
A102.080.R	B102.080.R	C102.080.R
A102.100.R	B102.100.R	C102.100.R
A103.080.R	B103.080.R	C103.080.R
A103.100.R	B103.100.R	C103.100.R
A103.120.R	B103.120.R	C103.120.R

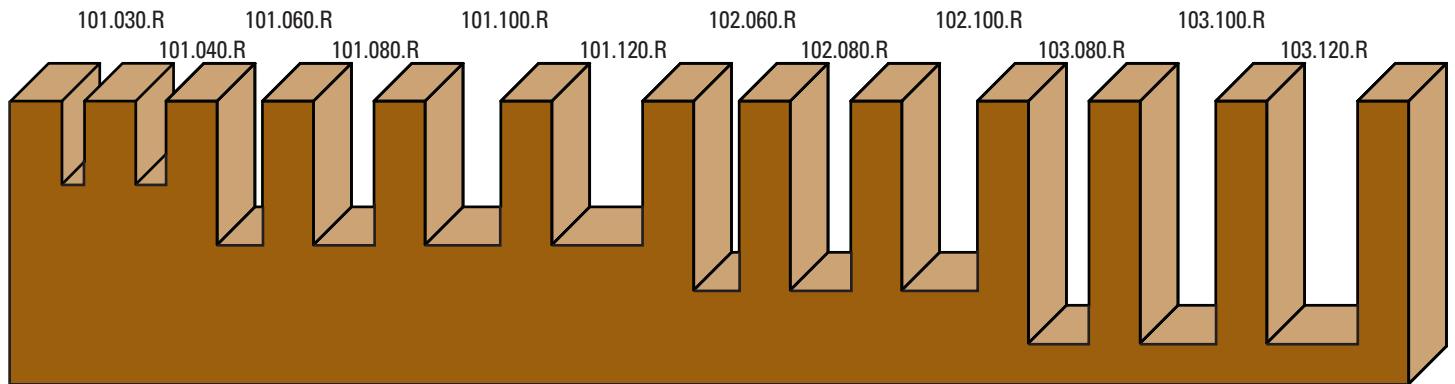

Scale 1:1

12 PIECE PROFILE ROUTER BITS "ADVANCED SET"

ART. X007



- Set including the 12 most popular T.C.T. router bits in a robust and practical wooden box.
- Ideal to have always on hand the right bit for trimming and profiling.

S Ø 6	S Ø 1/4" (6,35)	S Ø 8
X007.006.R	X007.064.R	X007.008.R
12-pcs router bit set:	12-pcs router bit set:	12-pcs router bit set:
A119.190.R	B119.190.R	C119.190.R
A120.127.R	B120.127.R	C120.127.R
A121.317.R	B121.317.R	C121.317.R
A122.317.R	B122.317.R	C122.317.R
A123.167.R	B123.167.R	C123.167.R
A123.187.R	B123.187.R	C123.187.R
A123.207.R	B123.207.R	C123.207.R
A123.227.R	B123.227.R	C123.227.R
A123.247.R	B123.247.R	C123.247.R
A123.286.R	B123.286.R	C123.286.R
A125.254.R	B125.254.R	C125.254.R
A127.254.R	B127.254.R	C127.254.R

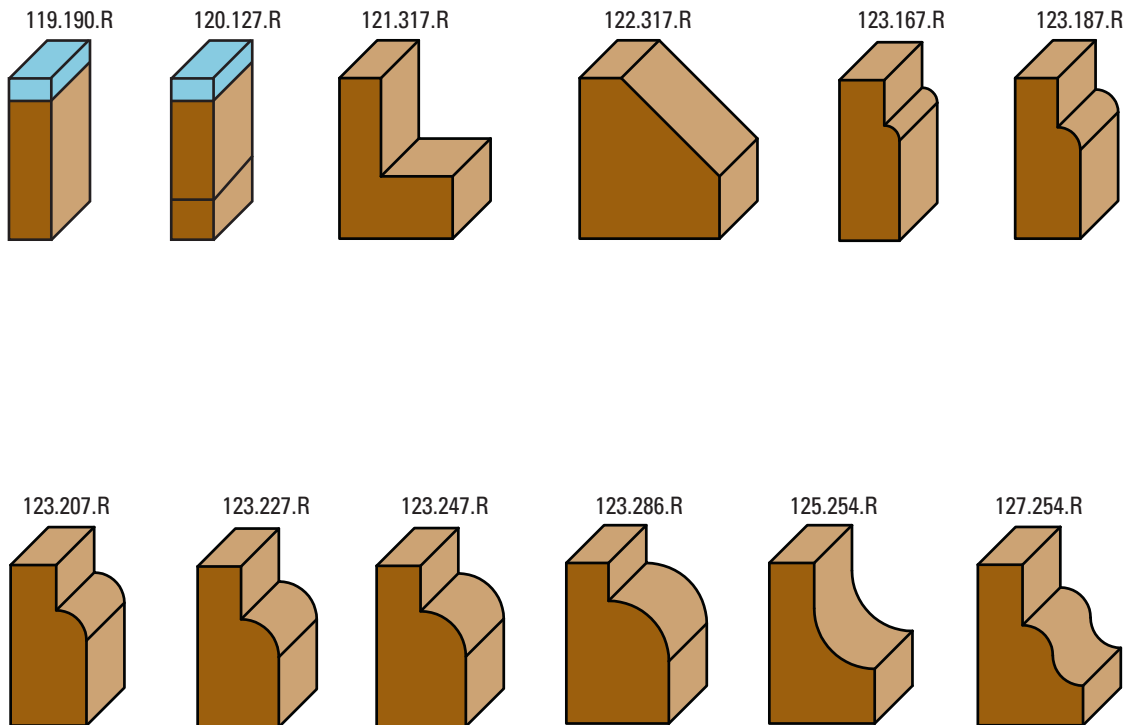

Scale 1:1

12 PIECE DOVETAIL BITS "ADVANCED SET"

ART. X008



- Set including the 12 most popular T.C.T. router bits in a robust and practical wooden box.
- Ideal to have the right bit for straight cuts and dovetail joints.

S Ø 6	S Ø 1/4" (6,35)	S Ø 8
X008.006.R	X008.064.R	X008.008.R
12-pcs router bit set:	12-pcs router bit set:	12-pcs router bit set:
A101.030.R	B101.030.R	C101.030.R
A101.040.R	B101.040.R	C101.040.R
A102.060.R	B102.060.R	C102.060.R
A102.080.R	B102.080.R	C102.080.R
A108.064.R	B108.064.R	C108.064.R
A108.080.R	B108.080.R	C108.080.R
A108.095.R	B108.095.R	C108.095.R
A108.127.R	B108.127.R	C108.127.R
A108.143.R	B108.143.R	C108.143.R
A108.150.R	B108.150.R	C108.150.R
A108.160.R	B108.160.R	C108.160.R
A108.190.R	B108.190.R	C108.190.R

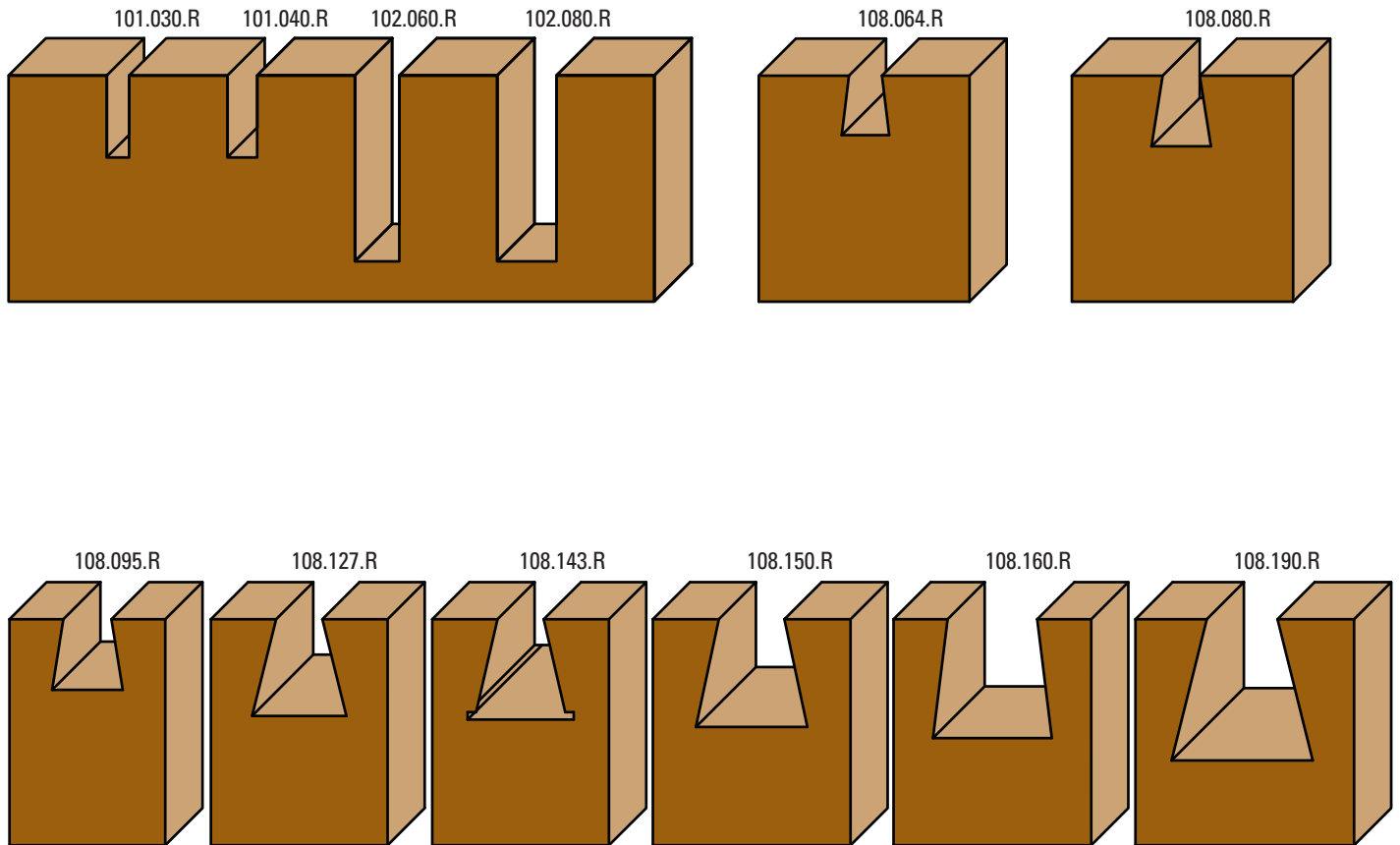

Scale 1:1

12 PIECE CORNER ROUNDING BITS "ADVANCED SET"

ART. X013



- Set including the 12 most popular T.C.T. router bits in a robust and practical wooden box.
- Ideal to have always on hand the right bit to produce corner roundings.

S Ø 6	S Ø 8
X013.006.R	X013.008.R
12-pcs router bit set:	12-pcs router bit set:
A123.160.R	C123.160.R
A123.167.R	C123.167.R
A123.187.R	C123.187.R
A123.190.R	C123.190.R
A123.207.R	C123.207.R
A123.222.R	C123.222.R
A123.227.R	C123.227.R
A123.247.R	C123.247.R
A123.254.R	C123.254.R
A123.286.R	C123.286.R
A123.318.R	C123.318.R
A123.327.R	C123.327.R

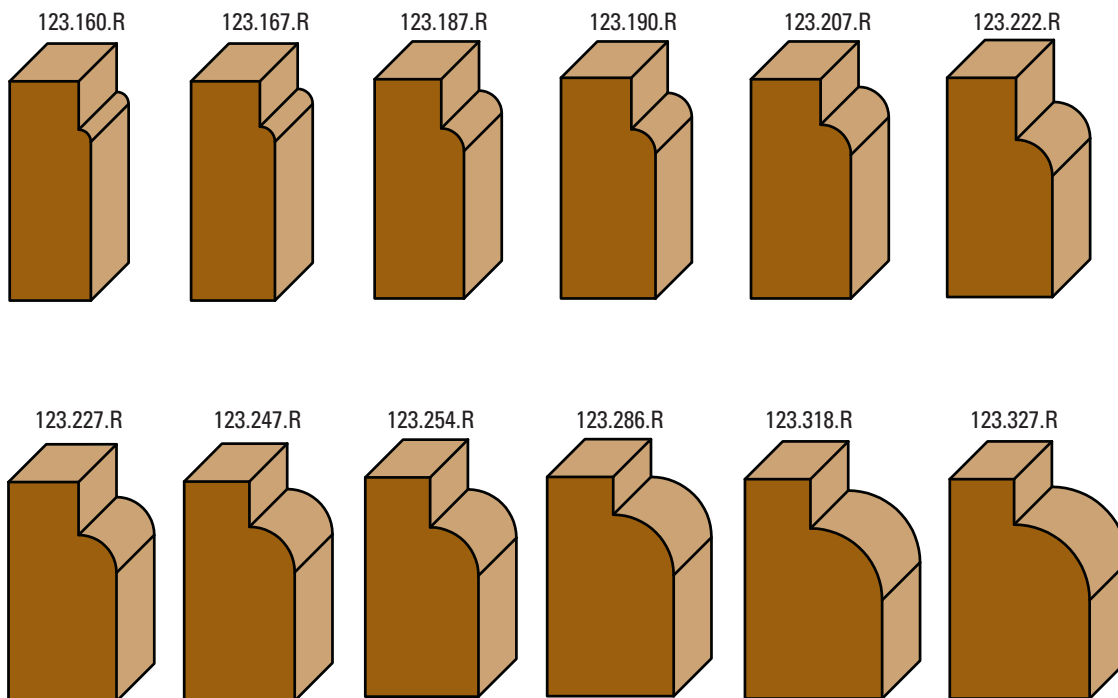

Scale 1:1

6 PIECE INSERT ROUTER BITS "SET"

ART. XWC



- Set including the 6 most popular HW router bits in S=8 in a robust and practical wooden box.
- Ideal to have always on hand the right bit for straight cuts, trimming and engraving.
- Router bits complete with reversible knives

S Ø 8

XWC.001.R

6-pcs router bit set:

WC101.120.R

WC109.176.R

WC111.127.R

WC120.127.R

WC121.286.R

WC122.273.R

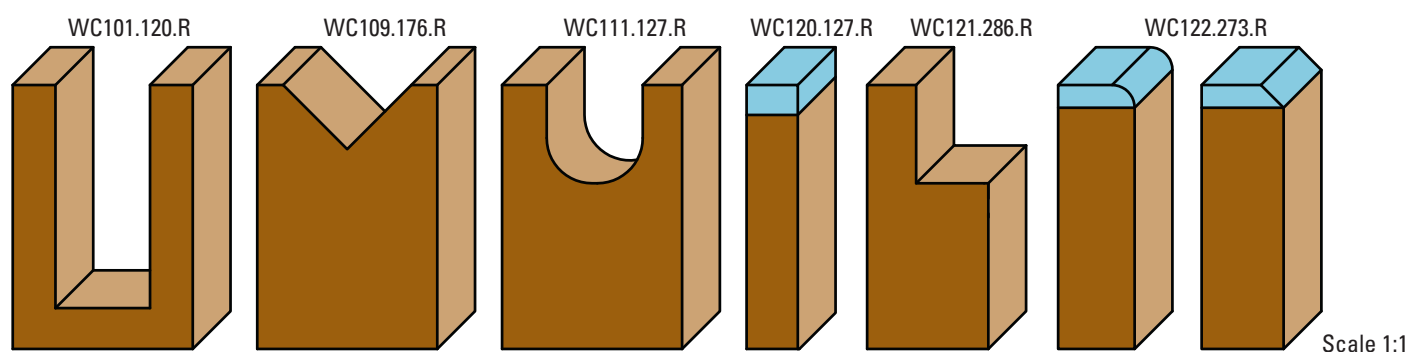

6 PIECE INSERT ROUTER BITS "SET"

ART. XWC



- Set including the 6 most popular HW router bits in S=8 in a robust and practical wooden box.
- Ideal to have always on hand the right bit for trimming and profiling.
- Router bits complete with reversible knives

S Ø 8

XWC.002.R

6-pcs router bit set:

WC120.127.R

WC121.286.R

WC122.273.R

WC123.260.R

WC125.260.R

WC129.260.R

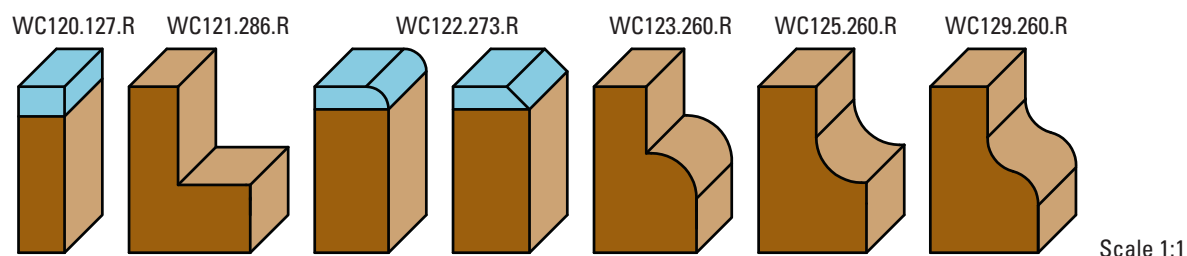

BASE

1 modular panel

Small display, ideal for starting with a basic assortment
Dimensions (cm): 110 (L) x 90 (H) x 30 (P)



Display code **Base 01**
 includes:
 Router bits S=6/8
 for portable routers
60 positions



Display code **Base 02**
 includes:
 Router bits S=12
 for portable routers
30 positions

**Display
 customizable**

STANDARD

2 modular panels

Consisting of two displays "BASE", can be composed according to customers' needs.
 Suitable for those who want a good variety of products waiting to increase and improve the offer range.

Dimensions (cm): 110 (L) x 145 (H) x 36 (P)

Display code **Standard 01**
 includes:
 Router bits S=6/8 for portable routers
120 positions

Display code **Standard 02**
 includes:
 Router bits S=12 for portable routers
60 positions

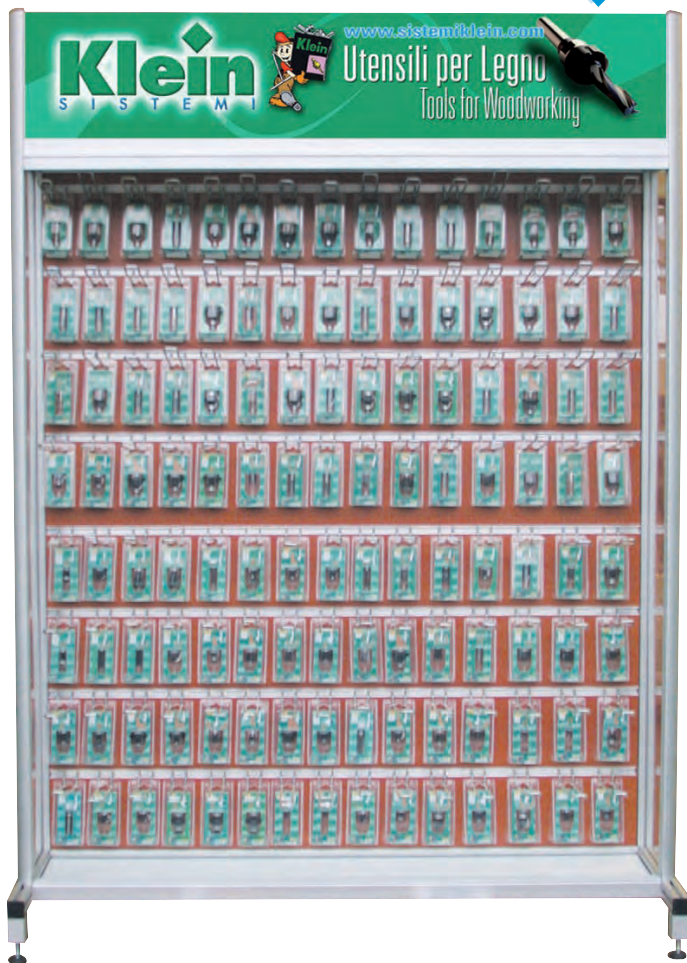

PROFESSIONAL

3 modular panels

Big display consisting of three panels BASE, allows you to display a large variety of items.
With two or more displays you get the complete assortment to meet all the needs of professional woodworkers.
Dimensions (cm): 110 (L) x 200 (H) x 36 (P)

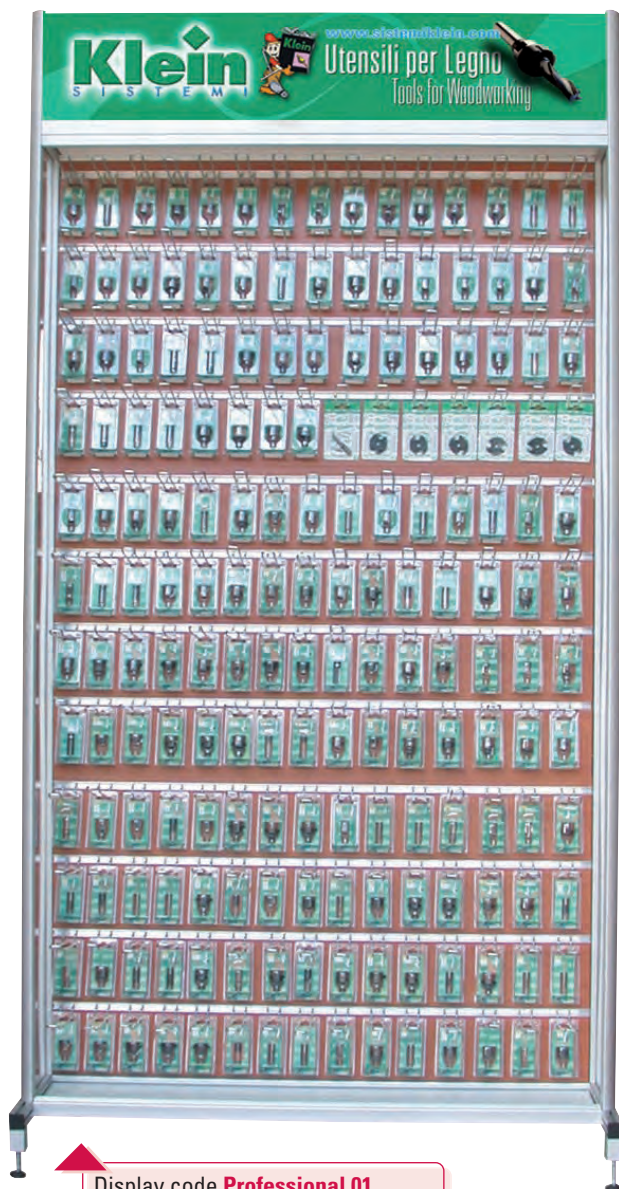

Display code **Professional 01**
includes:
Router bits for portable routers
S= 6/8 - 180 positions

Display
customizable

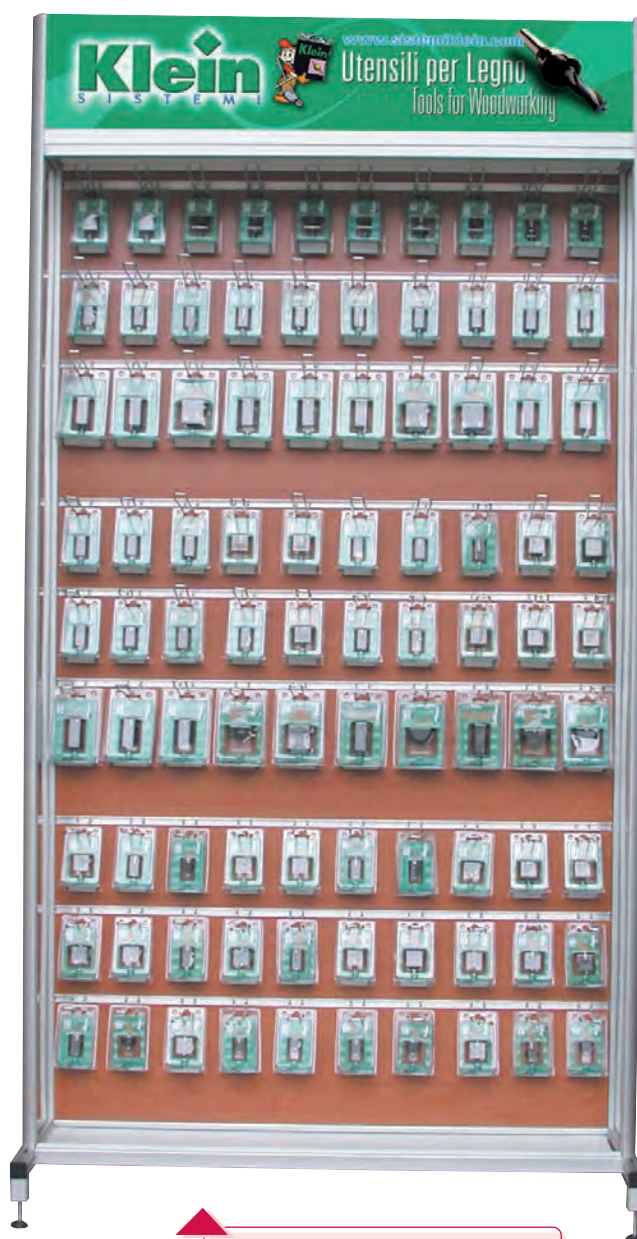

Display code **Professional 02**
includes:
Router bits for portable routers
S= 12 - 90 positions

ROUTER BITS FOR HAND PORTABLE ROUTER MACHINES S=Ø10 - S=Ø12 - S=Ø1/2"

2



HW STRAIGHT BITS Z=2+1
Page 2.07



HW STRAIGHT BITS LONG TYPE Z=2+1
Page 2.07



HW STRAIGHT BITS Z=2+1
Page 2.07



HW STRAIGHT BITS Z=2
Page 2.07



HW STRAIGHT BITS LONG TYPE Z=2
Page 2.08

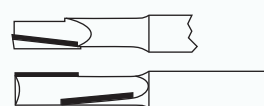

HW STAGGER BITS Z=2
Page 2.08



HW PANEL PILOT BITS Z=1+1
Page 2.08



HW PLUNGE TYPE OGEE BITS Z=2
Page 2.08



HW PLUNGE TYPE OGEE BITS Z=2
Page 2.08

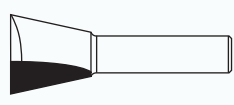

HW DOVETAIL BITS Z=2
Page 2.08

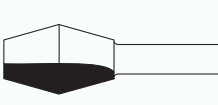

HW 14° BUTTERFLY SPLINE BITS Z=2
Page 2.09

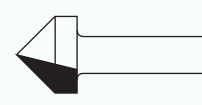

HW V-GROOVE BITS Z=2
Page 2.09



HW CORE BOX BITS Z=2
Page 2.09

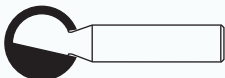

HW BALL AND PLUNGE BITS Z=2
Page 2.09



HW PLUNGING ROUND-OVER
BITS Z=2
Page 2.09

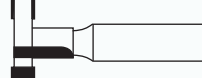

HW T-SLOT ROUTER BITS Z=2
Page 2.09



HW BULL NOSE RADIUS BITS Z=2
Page 2.10

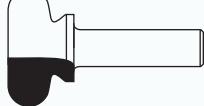

HW FINGER GRIP BITS Z=2
Page 2.10



HW FINGER GRIP BITS Z=2
Page 2.10



HW DRAWER LOCK BITS Z=2
Page 2.10

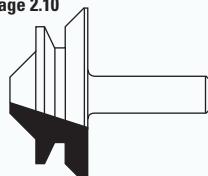

HW 45° MITER BITS Z=2
Page 2.10

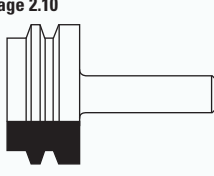

HW GLUE JOINT BITS Z=2
Page 2.10

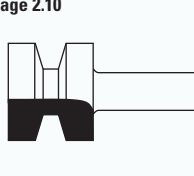

HW WEDGE TONGUE
AND GROOVE BITS Z=2
Page 2.11

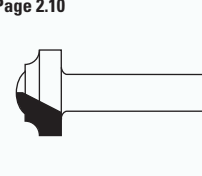

HW PROFILE BITS Z=2
Page 2.11



HW CROWN MOULDING BITS Z=2
Page 2.11



HW CROWN MOULDING BITS Z=2
Page 2.11

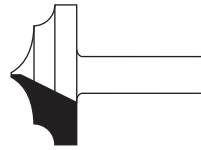

HW PROFILE BITS Z=2
Page 2.11



HW PROFILE BITS Z=2
Page 2.11

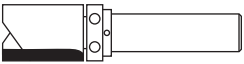

HW FLUSH TRIM BITS WITH
UPPER BALL BEARING GUIDE Z=2
Page 2.12

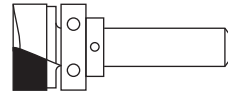

HW PLUNGE BITS WITH
UPPER BALL BEARING GUIDE Z=2
Page 2.12

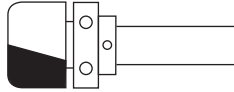

HW BOWL AND TRAY BITS WITH
UPPER BALL BEARING GUIDE Z=2
Page 2.12

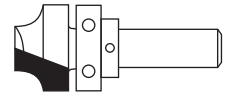

HW BEADING BITS WITH
UPPER BALL BEARING GUIDE Z=2
Page 2.12

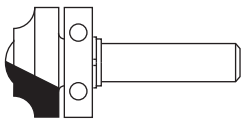

HW CLASSICAL PLUNGE BITS WITH
UPPER BALL BEARING GUIDE Z=2
Page 2.12

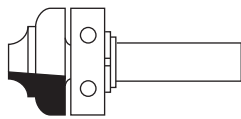

HW CLASSICAL PLUNGE BITS WITH
UPPER BALL BEARING GUIDE Z=2
Page 2.13

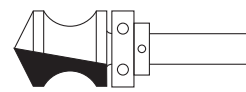

HW HAND GRIP PLUNGE BITS WITH
UPPER BALL BEARING GUIDE Z=2
Page 2.13



HW WINDOW SILL EDGE BITS Z=2
Page 2.13

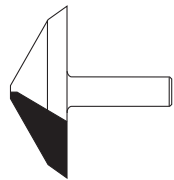

HW RAISED PANEL BITS Z=2
Page 2.13



HW DOUBLE RADIUS BITS Z=2
Page 2.13

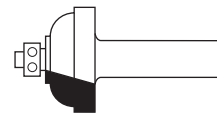

HW COVE BITS Z=2
Page 2.13

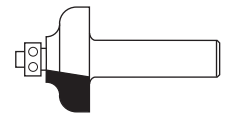

HW FLAT SUNK BEAD BITS Z=2
Page 2.14



HW SUNK BEAD BITS Z=2
Page 2.14

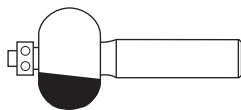

HW SUNK BEAD BITS Z=2
Page 2.14



HW FLAT ROUNDING-OVER BITS Z=2
Page 2.14

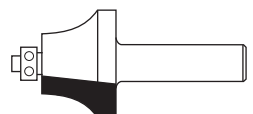

HW SUNK BEAD BITS Z=2
Page 2.14



HW COVE BITS WITH
BALL BEARING GUIDE
Page 2.14

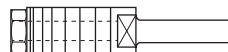

SLOT CUTTER ARBORS
Pag. 2.15

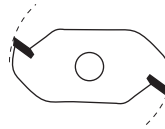

HW SLOT CUTTERS Z=2
Page 2.15

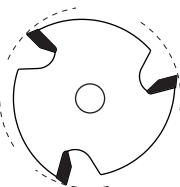

HW SLOT CUTTERS Z=3
Page 2.15

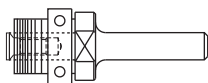

SLOT CUTTER ARBORS
Page 2.15

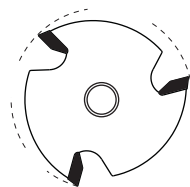

HW SLOT CUTTERS SPECIAL
FIXING SCREW Z=3
Page 2.15



HW FLUSH TRIM BITS WITH
BALL BEARING GUIDE Z=2
Page 2.16



HW FLUSH TRIM BITS WITH UPPER
AND LOWER BALL BEARING Z=2
Page 2.16



**SOLID CARBIDE COMPRESSION CUTTERS
Z=2+2 WITH DOUBLE BALL BEARING**
Pag. 2.16



**VHW FLUSH TRIM BITS WITH DOUBLE
BALL BEARINGS Z=2**
Page 2.16



HW INSERT FLUSH TRIMMING BITS Z=2
Page 2.16



HW FLUSH INSERT TRIMMING BITS Z=2
Page 2.17

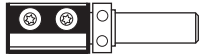

**HW INSERT FLUSH TRIMMING BITS WITH
UPPER AND LOWER BALL BEARINGS Z=2**
Page 2.17

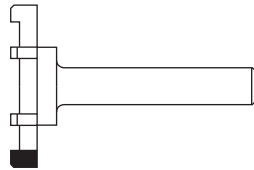

HW SPOILBOARD BITS Z=6
Page 2.17

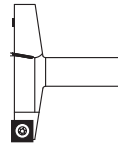

**HW INSERT ROUTER BITS FOR
PLANING AND RABBETING Z=3**
Page 2.17

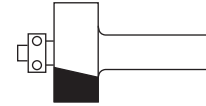

**HW RABBETING BITS WITH
BALL BEARING GUIDE Z=2**
Page 2.18

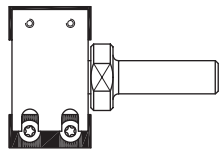

HW INSERT RABBETING BITS Z=2
Page 2.18

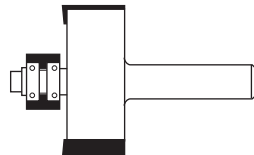

**HW RABBETING BITS WITH
BALL BEARING GUIDE Z=2**
Page 2.18

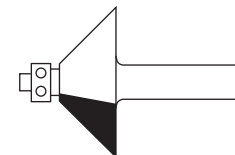

**HW BEVEL TRIM BITS WITH
BALL BEARING GUIDE Z=2**
Page 2.18

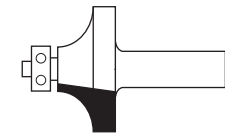

**HW CORNER ROUNDING BITS WITH
BALL BEARING GUIDE Z=2**
Page 2.19

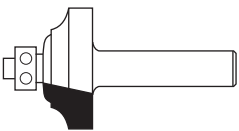

**HW CLASSICAL BITS WITH BALL
BEARING GUIDE Z=2**
Page 2.19

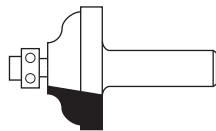

**HW OGEE BITS WITH BALL BEARING
GUIDE Z=2**
Page 2.19

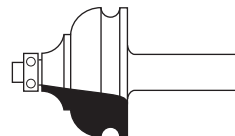

**HW MOULDING BITS WITH
BALL BEARING GUIDE Z=2**
Page 2.19

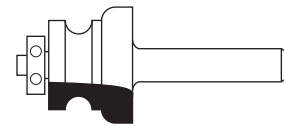

**HW MOULDING BITS WITH
BALL BEARING GUIDE Z=2**
Page 2.19



**HW MOULDING BITS WITH
BALL BEARING GUIDE Z=2**
Page 2.20

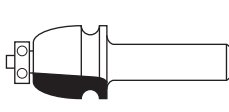

**HW DRAWING LINE BITS WITH
BALL BEARING GUIDE Z=2**
Page 2.20



**HW ROMAN OGEE BITS WITH
BALL BEARING GUIDE Z=2**
Page 2.20



**HW CLASSICAL OGEE BITS WITH
BALL BEARING GUIDE Z=2**
Page 2.20



**HW DRAWING LINE BITS WITH
BALL BEARING GUIDE Z=2**
Page 2.21



**HW ARCHITECTURAL MOULDING LINE
BITS WITH BALL BEARING GUIDE Z=2**
Page 2.21



**HW ARCHITECTURAL MOULDING LINE
BITS WITH BALL BEARING GUIDE Z=2**
Page 2.21



HW MULTI RADIUS BITS Z=2
Page 2.21

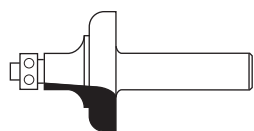

HW MULTIPLE PROFILE BITS Z=2
Page 2.21

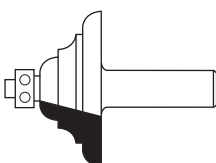

HW MULTIPLE PROFILE BITS Z=2
Page 2.21

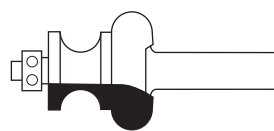

HW MULTIPLE PROFILE BITS Z=2
Page 2.21



**HW BEADING BITS FOR RADIUS
WINDOW Z=2**
Page 2.22

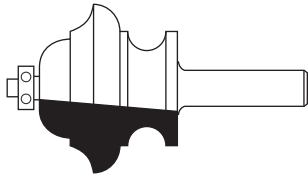

HW CLASSICAL MULTI-FORM BITS
WITH BALL BEARING GUIDE Z=2
Page 2.22



HW HANDRAIL BITS WITH
BALL BEARING GUIDE Z=2
Page 2.22

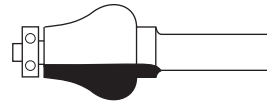

HW HANDRAIL BITS WITH
BALL BEARING GUIDE Z=2
Page 2.23

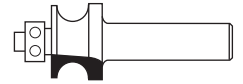

HW EDGE BEADING BITS Z=2
Page 2.23

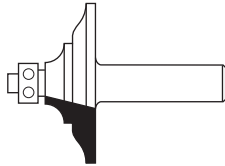

HW HANDRAIL AND TABLE EDGE BITS Z=2
Page 2.23

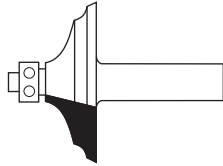

HW HANDRAIL AND TABLE EDGE BITS Z=2
Page 2.23

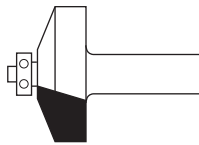

HW RAISED PANEL BITS WITH
BALL BEARING GUIDE Z=2
Page 2.23

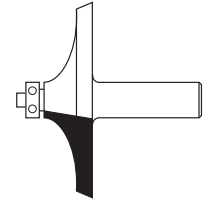

HW HANDRAIL-TABLE EDGE BITS
WITH BALL BEARING GUIDE Z=2
Page 2.23

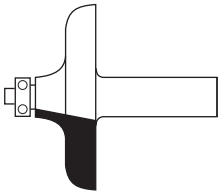

HW HANDRAIL-TABLE EDGE BITS
WITH BALL BEARING GUIDE Z=2
Page 2.24

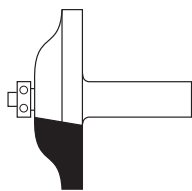

HW RAISED PANEL BITS WITH
BALL BEARING GUIDE Z=2
Page 2.24

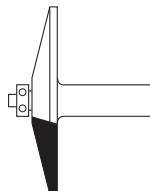

HW RAISED PANEL BITS WITH
BALL BEARING GUIDE Z=2
Page 2.24

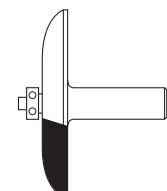

HW RAISED PANEL BITS WITH
BALL BEARING GUIDE Z=2
Page 2.24

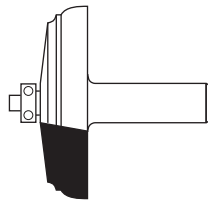

HW RAISED PANEL BITS WITH
BALL BEARING GUIDE Z=2
Page 2.24

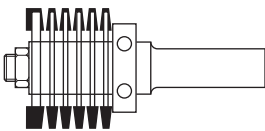

HW FINGER JOINT ASSEMBLY
WITH BALL BEARING GUIDE Z=2
Page 2.25

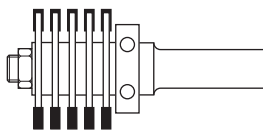

HW FINGER JOINT ASSEMBLY
WITH BALL BEARING GUIDE Z=3
Page 2.25

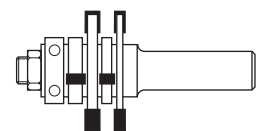

HW SLOT CUTTER SET WITH
BALL BEARING GUIDE Z=2
Page 2.26

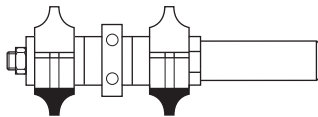

HW DOUBLE CORNER ROUND ASSEMBLY
WITH BALL BEARING GUIDE Z=3
Page 2.26

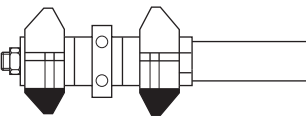

HW DOUBLE CHAMFER ASSEMBLY WITH
BALL BEARING GUIDE Z=3
Page 2.27

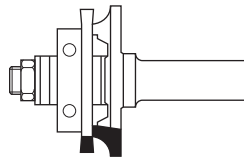

HW BEAD PANELING ASSEMBLY
WITH BALL BEARING GUIDE Z=2
Page 2.27

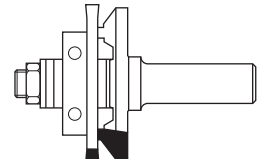

HW V PANELING ASSEMBLY
WITH BALL BEARING GUIDE Z=2
Page 2.28

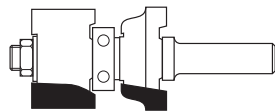

HW OGEE WINDOW SASH ASSEMBLY WITH
BALL BEARING GUIDE Z=2
Page 2.28

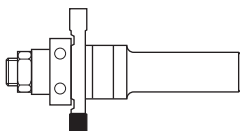

HW TONGUE AND GROOVE ASSEMBLY
WITH BALL BEARING GUIDE Z=2
Page 2.29

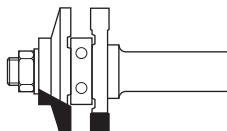

HW STILE AND RAIL ASSEMBLY
WITH BALL BEARING GUIDE Z=2
Page 2.29

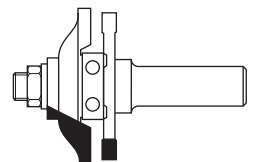

HW STILE AND RAIL ASSEMBLY
WITH BALL BEARING GUIDE Z=2
Page 2.30

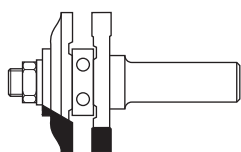

HW STILE AND RAIL ASSEMBLY WITH
BALL BEARING GUIDE Z=2
Page 2.30

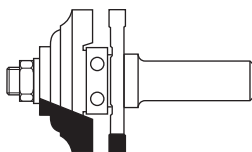

HW STILE AND RAIL ASSEMBLY WITH
BALL BEARING GUIDE Z=2
Page 2.31

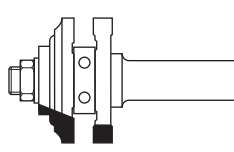

HW STILE AND RAIL ASSEMBLY WITH
BALL BEARING GUIDE Z=2
Page 2.31



2 PIECE SET FOR CABINET DOORS
MAKER "TYPE 1"
Page 2.32



2 PIECE SET FOR CABINET DOORS
MAKER "TYPE 2"
Pag. 2.32



2 PIECE SET FOR CABINET DOORS
MAKER "TYPE 3"
Pag. 2.33



3 PIECE SET FOR CABINET DOORS
MAKER AND JOINTS "TYPE 1"
Pag. 2.33



3 PIECE SET FOR CABINET DOORS MAKER
AND JOINTS "TYPE 2"
Page 2.34



3 PIECE SET FOR CABINET DOORS
MAKER AND JOINTS "TYPE 3"
Page 2.34

INDUSTRIAL ROUTER BITS FOR HAND PORTABLE ROUTER MACHINE AND ROUTER TABLE



STRAIGHT AND TRIMMING ROUTER BITS

Router bits specially designed to work at different cutting heights and diameters. In addition to the lateral cutting edges, many of them also have a third cutting edge at the head to perform drilling operations (Z=2+1).

See page 2.07-2.08 / 2.12 / 2.16



SLOT CUTTER AND ASSEMBLY ROUTER BITS

Router bits for all the types of jointing. The ball bearing guide defines the depth of the cut, ideal for grooves, frames, doors and edges.

See page 2.15 / 2.25-2.34



ROUTER BITS WITH INTERCHANGEABLE KNIVES

The interchangeable knife is easy to replace and provide an excellent precision and cutting accuracy with the best quality/price ratio. Longer tool life and better finishing quality.

See page 2.17-2.18



RADIUS AND PROFILE ROUTER BITS

All the router bits with a profile or shape on the cutting edge allow you to decorate the wood as you wish. Some of them have a ball bearing guide.

See page 2.09-2.14 / 2.18-2.24



ENGRAVING AND DECORATING ROUTER BITS

Router bits for all the types of jointing. Router bits with a special "V" or "U" head profile let you carve wood easily and precisely. These router bits are useful for lettering, incision signmaking and decorations on wood.

See page 2.09



SPIRAL ROUTER BITS

The spiral solid carbide router bits have a special design, which guarantees an extremely precise and clean cut because the cutting edges facilitate the wood chips expulsion.

See page 2.16 or go to section 7

HW STRAIGHT BITS Z=2+1

ART. D101

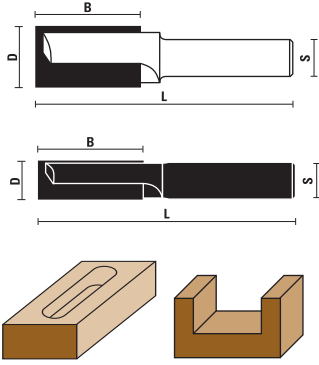

- Straight cut Z=2+1, plunging
- To be used also for working plastic materials, acrylic, polypropylene, HDPE, acetates and polycarbonates



S Ø 10	D	B	L
D101.040.R ▲	4	13	49
D101.050.R ▲	5	15	49
D101.060.R ▲	6	16	53
D101.070.R ▲	7	20	55
D101.080.R ▲	8	23	60
D101.090.R ▲	9	23	60
D101.100.R ▲	10	23	70
D101.120.R	12	23	70
D101.140.R	14	23	70
D101.150.R	15	23	70
D101.160.R	16	23	70
D101.180.R	18	23	70
D101.200.R	20	23	70
D101.220.R	22	23	70
D101.240.R	24	23	70

▲ Solid carbide

HW STRAIGHT BITS LONG TYPE Z=2+1

ART. D102

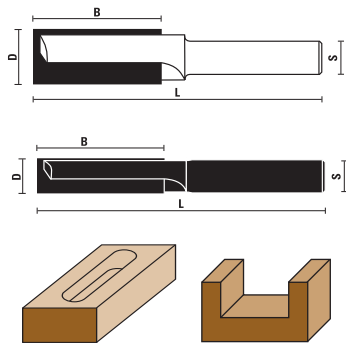

- Straight cut Z=2+1, plunging
- To be used also for working plastic materials, acrylic, polypropylene, HDPE, acetates and polycarbonates



S Ø 10	D	B	L
D102.100.R ▲	10	40	87
D102.120.R	12	40	87
D102.140.R	14	40	87
D102.160.R	16	45	87
D102.180.R	18	45	87
D102.200.R	20	45	87

▲ Solid carbide

Z=2+1

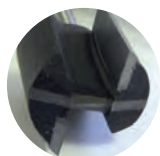

HW STRAIGHT BITS Z=2+1

ART. D103

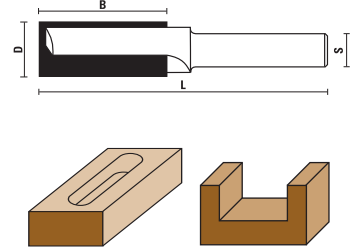

- Straight cut Z=2+1, plunging
- To be used also for working plastic materials, acrylic, polypropylene, HDPE, acetates and polycarbonates



S Ø 12	D	B	L
D103.100.R	10	35	90
D103.120.R	12	35	90
D103.121.R	12	45	90
D103.140.R	14	35	90
D103.141.R	14	50	100
D103.160.R	16	35	90
D103.161.R	16	50	100
D103.180.R	18	35	90
D103.181.R	18	50	100
D103.200.R	20	35	90
D103.201.R	20	50	100
D103.220.R	22	35	90
D103.240.R	24	35	90

HW STRAIGHT BITS Z=2

ART. E101 - G101

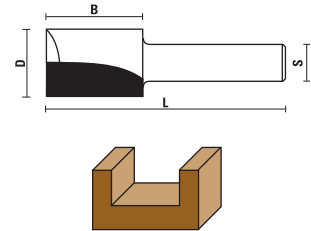

S Ø 12	S Ø 1/2" (12,7)	D	B	L
E101.040.R		4	11	63
E101.050.R		5	11	60
E101.060.R	G101.060.R	6	19	63
	G101.064.R	6,4	19	63
E101.070.R		7	19	63
E101.080.R	G101.080.R	8	19	63
	G101.095.R	9,5	25	70
E101.100.R	G101.100.R	10	25	70
E101.120.R		12	25	70
	G101.127.R	12,7	25	66
E101.140.R		14	32	73
	G101.143.R	14,3	32	73
E101.150.R		15	25	66
E101.160.R	G101.160.R	16	32	73
E101.170.R		17	32	73
E101.180.R		18	32	73
E101.190.R		19	32	73
E101.200.R		20	32	73
E101.220.R		22	32	73
E101.250.R		25	32	73
	G101.254.R	25,4	32	73
E101.300.R		30	32	73
E101.350.R		35	32	73
E101.400.R		40	32	73

HW STRAIGHT BITS Z=2 LONG TYPE

ART. E102 - G102 / E103 - G103

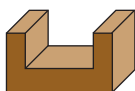
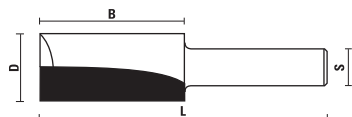

S Ø 12	S Ø 1/2"(12,7)	D	B	L
E102.080.R		8	25	70
	G102.095.R	9,5	32	76
E102.100.R	G102.100.R	10	32	76
E102.120.R	G102.120.R	12	38	80
	G102.127.R	12,7	38	80
E102.160.R	G102.160.R	16	38	80
E102.190.R	G102.190.R	19	38	80
E103.120.R	G103.120.R	12	50	108
	G103.127.R	12,7	50	108
E103.180.R		18	50	92
E103.200.R		20	50	92
E103.220.R		22	50	92

HW STAGGER BITS Z=2

ART. E104 - G104

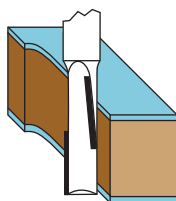
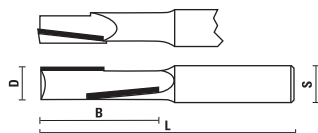

- Excellent for working laminated, panel, melaminic, veneered and plywood
- Good finishing top/bottom



S Ø 12	S Ø 1/2"(12,7)	D	B	L
E104.127.R	G104.127.R	12,7	38	79
E104.128.R	G104.128.R	12,7	54	108

HW PANEL PILOT BITS Z=1+1

ART. E105 - G105

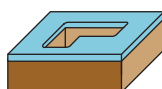
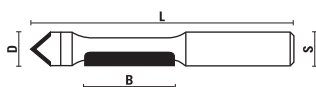

S Ø 12	S Ø 1/2"(12,7)	D	B	L
E105.127.R	G105.127.R	12,7	30	90

HW PLUNGE TYPE OGEE BITS Z=2

ART. E106 - G106

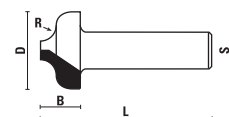

S Ø 12	S Ø 1/2"(12,7)	D	R	B	L
E106.190.R	G106.190.R	19	3,5	13	68
E106.254.R	G106.254.R	25,4	3,2	9,5	50
E106.350.R	G106.350.R	35	3,2	9,5	59

HW PLUNGE TYPE OGEE BITS Z=2

ART. E107 - G107

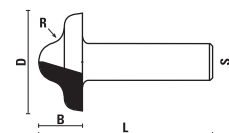

S Ø 12	S Ø 1/2"(12,7)	D	R	B	L
E107.270.R	G107.270.R	27	6	12	57

HW DOVETAIL BITS Z=2

ART. E108 - G108

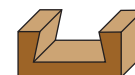
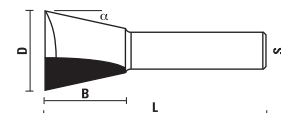

S Ø 12	S Ø 1/2"(12,7)	D	α	B	L
E108.161.R	G108.161.R	16	7°	22	65
E108.190.R	G108.190.R	19	14°	19	65
E108.191.R	G108.191.R	19	7°	22	65
E108.220.R	G108.220.R	22	14°	22	67
E108.221.R	G108.221.R	22	7°	22	60
E108.254.R	G108.254.R	25,4	14°	25,4	70

HW 14° BUTTERFLY SPLINE BITS Z=2

ART. E109 - G109

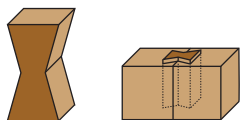
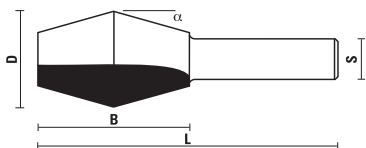

S Ø 12	S Ø 1/2" (12,7)	D	α	B	L
E109.280.R	G109.280.R	28	14°	46	84

HW V-GROOVE BITS Z=2

ART. E110 - G110

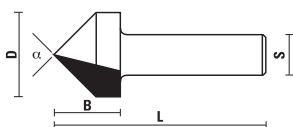

S Ø 12	S Ø 1/2" (12,7)	D	α	B	L
E110.127.R	G110.127.R	12,7	90°	13	54
E110.160.R	G110.160.R	16	90°	13	51
E110.190.R	G110.190.R	19	90°	16	54
E110.254.R	G110.254.R	25,4	90°	19	57
E110.320.R	G110.320.R	32	90°	25	64
E110.381.R	G110.381.R	38,1	90°	32	70
E110.501.R	G110.501.R	51	90°	44	83

HW CORE BOX BITS Z=2

ART. E111 - G111

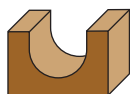
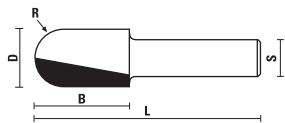

S Ø 12	S Ø 1/2" (12,7)	D	R	B	L
E111.127.R	G111.127.R	12,7	6,4	32	73
E111.160.R	G111.160.R	16	8	32	70
E111.190.R	G111.190.R	19	9,5	32	70
E111.220.R	G111.220.R	22	11	32	70
E111.254.R	G111.254.R	25,4	12,7	32	70
E111.317.R	G111.317.R	32	16	32	70
E111.380.R	G111.380.R	38	19	32	70
E111.500.R	G111.500.R	50	25	32	70

HW BALL AND PLUNGE BITS Z=2

ART. E112 - G112

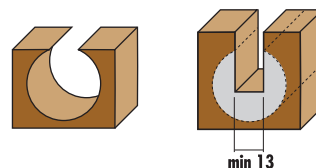
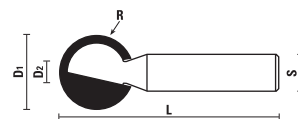

These tools can produce grooves for sliding panels or electrical wires, after a first groove which allows the tool shank moving



S Ø 12	S Ø 1/2" (12,7)	D1	D2	R	L
E112.127.R	G112.127.R	12,7	6,5	6,4	57
E112.160.R	G112.160.R	16	7,5	8	60
E112.190.R	G112.190.R	19	8,5	9,5	64
E112.254.R	G112.254.R	25,4	9	12,7	70
E112.286.R*		28,6	10,3	14,3	70
E112.320.R	G112.320.R	32	12,7	16	73

* Selling out

HW PLUNGING ROUND-OVER BITS Z=2

ART. E113 - G113

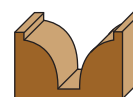
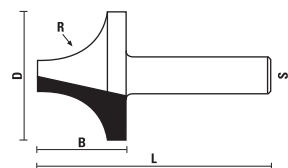

S Ø 12	S Ø 1/2" (12,7)	D	R	B	L
E113.160.R	G113.160.R	16	5	11	49
E113.190.R	G113.190.R	19	6,4	13	51
E113.220.R	G113.220.R	22	8	14	52
E113.254.R	G113.254.R	25,4	9,5	16	54
E113.349.R	G113.349.R	34,9	12,7	25,4	63,5
E113.445.R	G113.445.R	44,5	16	31,8	70
E113.510.R	G113.510.R	51	19	36	75

HW T-SLOT ROUTER BITS Z=2

ART. E114 - G114

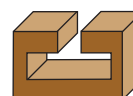
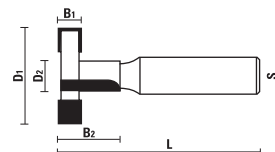

S Ø 12	S Ø 1/2" (12,7)	D1	D2	B1	B2	L
E114.280.R	G114.280.R	28	9,5	8	21	65
E114.350.R	G114.350.R	35	13	9,5	22	65

HW BULL NOSE RADIUS BITS Z=2

ART. E115 - G115

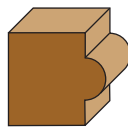
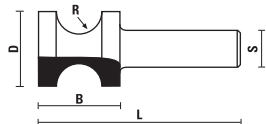

S Ø 12	S Ø 1/2"(12,7)	D	R	B	L
E115.220.R	G115.220.R	22	5	19	57
E115.260.R	G115.260.R	26	6,8	25	63
E115.280.R	G115.280.R	28	8	25	64
E115.333.R	G115.333.R	33,3	9,5	35	73
E115.429.R	G115.429.R	42,9	12,7	40	78
E115.510.R	G115.510.R	51	16	50	88
E115.600.R	G115.600.R - max RPM 18.000	60	19	50	88

HW FINGER GRIP BITS Z=2

ART. E116 - G116

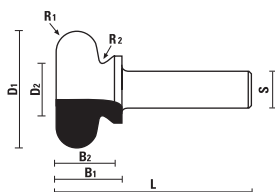

S Ø 12	S Ø 1/2"(12,7)	D1	D2	R1	R2	B1	B2	L
E116.190.R	G116.190.R	19	10	4,8	2,5	19	14	57
E116.381.R	G116.381.R	38,1	17	6	2	21	18	59
E116.445.R	G116.445.R	44,5	17	8	2	25	22	63

HW FINGER GRIP BITS Z=2

ART. E118 - G118

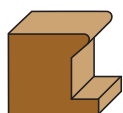
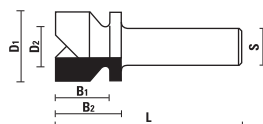

S Ø 12	S Ø 1/2"(12,7)	D1	D2	B1	B2	L
E118.220.R	G118.220.R	22	13	17	21	59

HW DRAWER LOCK BITS Z=2

ART. E119 - G119

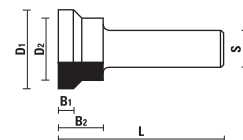

S Ø 12	S Ø 1/2"(12,7)	D1	D2	B1	B2	L
E119.254.R	G119.254.R	25,4	18,5	4	13	49

HW 45° LOCK MITER BITS Z=2

ART. E120 - G120

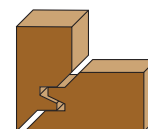
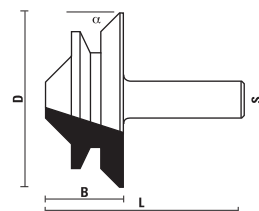
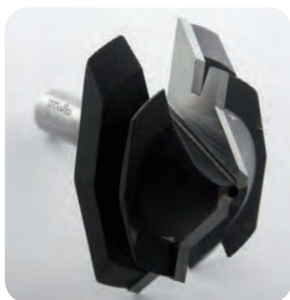

S Ø 12	S Ø 1/2"(12,7)	D	α	B	L
E120.445.R	G120.445.R	44,5	45°	20	58
E120.680.R	G120.680.R - max RPM 18.000	68	45°	29,5	68

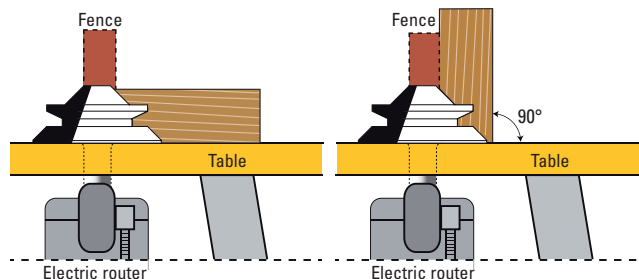

HW GLUE JOINT BITS Z=2

ART. E121 - G121

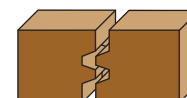
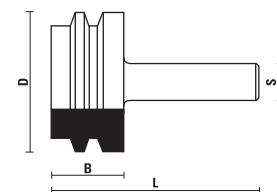

S Ø 12	S Ø 1/2"(12,7)	D	B	L
E121.470.R	G121.470.R	47	28	66

HW WEDGE TONGUE AND GROOVE BITS Z=2

ART. E122 - G122 / E123 - G123

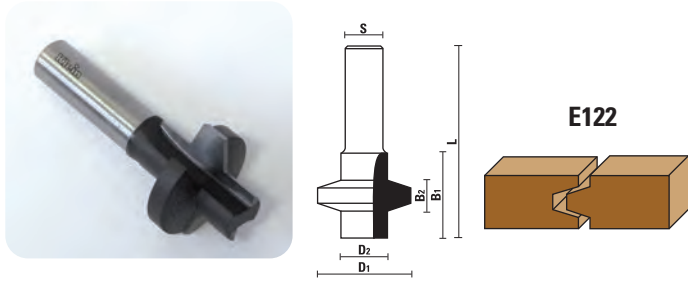

E122

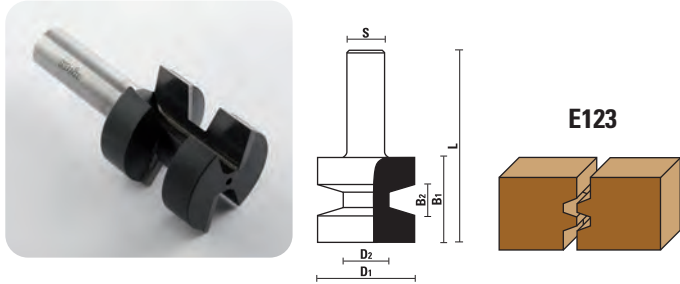

E123



S Ø 12	S Ø 1/2" (12,7)	D1	D2	α	B1	B2	L
E122.320.R	G122.320.R	32	14	15°	32	11	70
E123.320.R	G123.320.R	32	14	15°	32	11	70

HW PROFILE BITS Z=2

ART. E124 - G124

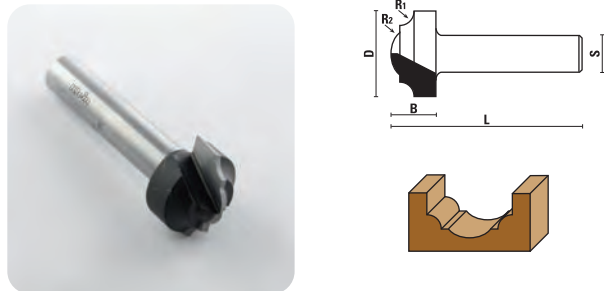

S Ø 12	S Ø 1/2" (12,7)	D	R1	R2	B	L
E124.190.R	G124.190.R	19	3,6	4	13	70
E124.254.R	G124.254.R	25,4	5	6,4	17,5	73

HW CROWN MOULDING BITS Z=2

ART. E125 - G125



S Ø 12	S Ø 1/2" (12,7)	D	B	L
E125.320.R*	G125.320.R*	32	58	96

* Selling out

HW CROWN MOULDING BITS Z=2

ART. E127 - G127



S Ø 12	S Ø 1/2" (12,7)	D	B	L
E127.320.R	G127.320.R	32	58	96

HW PROFILE BITS Z=2

ART. E128 - G128

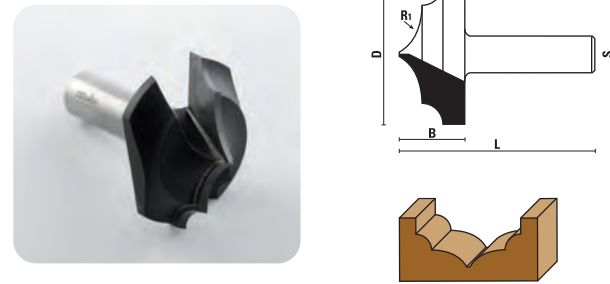

For producing ornaments

S Ø 12	S Ø 1/2" (12,7)	D	R1	R2	B	L
E128.410.R	G128.410.R	41	6,4	15	18	56

HW PROFILE BITS Z=2

ART. E129 - G129

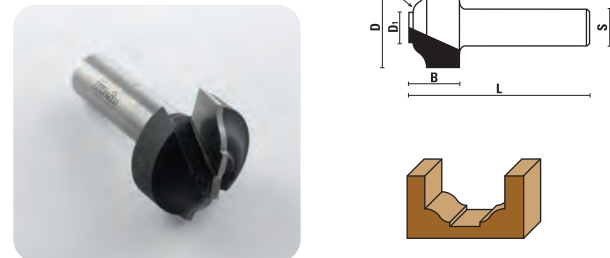

S Ø 12	S Ø 1/2" (12,7)	D	D1	R	B	L
E129.254.R	G129.254.R	25,4	9,5	4,8	15	53
E129.300.R	G129.300.R	30	12	6	15	53

HW FLUSH TRIM BITS WITH UPPER BALL BEARING GUIDE Z=2

ART. E130 - G130

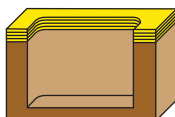
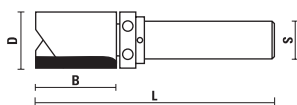

S Ø 12	S Ø 1/2" (12,7)	D	B	L
E130.190.R	G130.190.R	19	25,4	77
E130.191.R	G130.191.R	19	51	92



Z050.012.N



Z058.002.N



Z051.005.N

S Ø 12	S Ø 1/2" (12,7)	D	B	L
E130.254.R	G130.254.R	25,4	45	95



Z050.009.N



Z058.002.N



Z051.005.N

HW PLUNGE BITS WITH UPPER BALL BEARING GUIDE Z=2

ART. E131 - G131

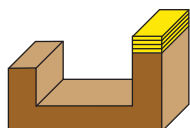
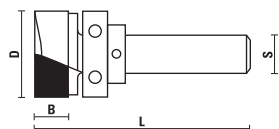

S Ø 12	S Ø 1/2" (12,7)	D	B	L
E131.190.R	G131.190.R	19	11	64



Z050.012.N



Z058.002.N



Z051.005.N

S Ø 12	S Ø 1/2" (12,7)	D	B	L
E131.254.R	G131.254.R	25,4	11	64



Z050.009.N



Z058.002.N



Z051.005.N

S Ø 12	S Ø 1/2" (12,7)	D	B	L
E131.380.R	G131.380.R	38	16	69



Z050.013.N



Z058.003.N



Z051.005.N

HW BOWL AND TRAY BITS WITH UPPER BALL BEARING GUIDE Z=2

ART. E132 - G132

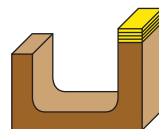
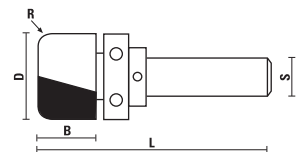

S Ø 12	S Ø 1/2" (12,7)	D	R	B	L
E132.190.R	G132.190.R	19	6,4	16	67



Z050.012.N



Z058.002.N



Z051.005.N

S Ø 12	S Ø 1/2" (12,7)	D	R	B	L
E132.286.R	G132.286.R	28,6	6,4	16	67



Z050.015.N



Z058.003.N



Z051.005.N

HW BEADING BITS WITH UPPER BALL BEARING GUIDE Z=2

ART. E133

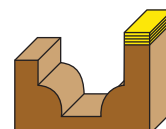
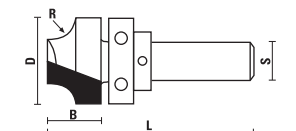

S Ø 12	D	R	B	L
E133.286.R*	28,6	8	15	58

* Selling out



Z050.015.N



Z058.003.N



Z051.005.N

HW CLASSICAL PLUNGE BITS WITH UPPER BALL BEARING GUIDE Z=2

ART. E134 - G134

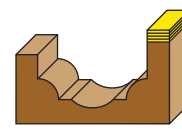
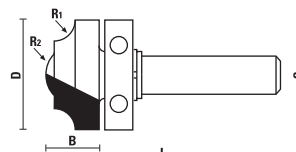

For producing ornaments

S Ø 12	S Ø 1/2" (12,7)	D	R1	R2	B	L
E134.350.R	G134.350.R	35	6,4	10	15	68



Z050.014.N



DIN 471-15

HW CLASSICAL PLUNGE BITS WITH UPPER BALL BEARING GUIDE Z=2

ART. E135 - G135

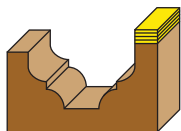
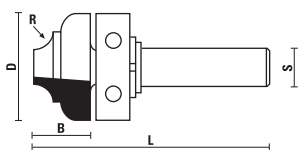

S Ø 12	S Ø 1/2" (12,7)	D	R	B	L
E135.350.R	G135.350.R	35	5	14	67



Z050.014.N



DIN 471-15

HW HAND GRIP PLUNGE BITS WITH UPPER BALL BEARING GUIDE Z=2

ART. E136 - G136

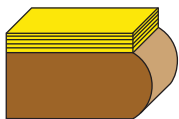
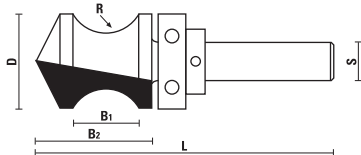

S Ø 12	S Ø 1/2" (12,7)	D	R	B1	B2	L
E136.286.R	G136.286.R	28,6	13	22	40	92



Z050.015.N



Z058.003.N



Z051.005.N

HW WINDOW SILL EDGE BITS Z=2

ART. E137 - G137

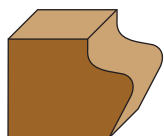
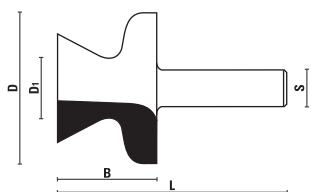

S Ø 12	S Ø 1/2" (12,7)	D	D1	B	L
E137.510.R	G137.510.R	51	19	32	70

HW RAISED PANEL BITS Z=2

ART. E138 - G138

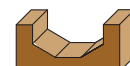
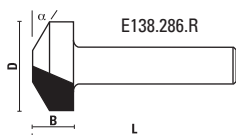
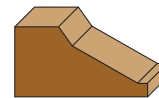
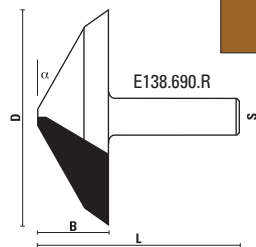

S Ø 12	S Ø 1/2" (12,7)	D	α	B	L
E138.286.R	G138.286.R	28,6	30°	13	70
E138.690.R	G138.690.R - max RPM 18.000	69	25°	19	57

HW DOUBLE RADIUS BITS Z=2

ART. E139 - G139

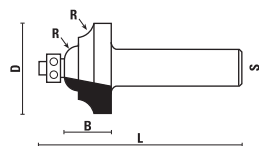

S Ø 12	S Ø 1/2" (12,7)	D	R	B	L
E139.254.R	G139.254.R	25,4	4	16	63
E139.350.R	G139.350.R	35	6,4	20	67



Z050.001.N



Z053.001.N



Z054.001.N



Z051.001.R

HW COVE BITS Z=2

ART. E140 - G140

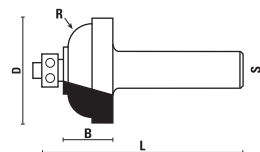

S Ø 12	S Ø 1/2" (12,7)	D	R	B	L
E140.286.R	G140.286.R	28,6	4,8	13	61
E140.350.R*		35	8	16	64

* Selling out



Z050.003.N



Z053.003.N



Z054.002.N



Z051.002.R

HW FLAT SUNK BEAD BITS Z=2

ART. E141 - G141

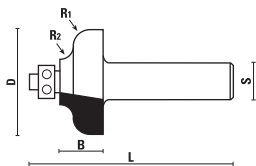

S Ø 12	S Ø 1/2"(12,7)	D	R1	R2	B	L
E141.350.R	G141.350.R	35	6	5	17,5	65

Z050.002.N

Z053.002.N

Z054.002.N

Z051.002.R

HW SUNK BEAD BITS Z=2

ART. E142 - G142

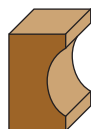
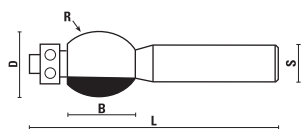

S Ø 12	S Ø 1/2"(12,7)	D	R	B	L
E142.190.R	G142.190.R	19	8	13	70
E142.220.R	G142.220.R	22	12	19	78
E142.254.R	G142.254.R	25,4	32	38	98

Z050.003.N

Z053.003.N

Z054.002.N

Z051.002.R

HW SUNK BEAD BITS Z=2

ART. E143 - G143

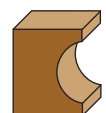
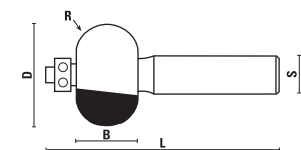

S Ø 12	S Ø 1/2"(12,7)	D	R	B	L
E143.330.R	G143.330.R	33	10	20	75

Z050.003.N

Z053.003.N

Z054.002.N

Z051.002.R

HW FLAT ROUNDING-OVER BITS Z=2

ART. E144 - G144

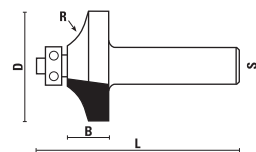

S Ø 12	S Ø 1/2"(12,7)	D	R	B	L
E144.300.R	G144.300.R	30	12	10	57

Z050.003.N

Z053.003.N

Z054.002.N

Z051.002.R

HW SUNK BEAD BITS Z=2

ART. E145 - G145

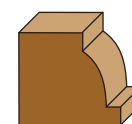
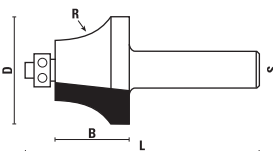

S Ø 12	S Ø 1/2"(12,7)	D	R	B	L
E145.270.R	G145.270.R	27	17	17	67

Z050.003.N

Z053.003.N

Z054.002.N

Z051.002.R

HW COVE BITS WITH BALL BEARING GUIDE

ART. E147 - G147

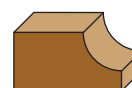
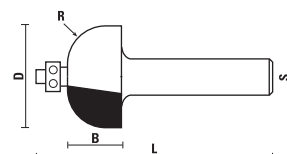

S Ø 12	S Ø 1/2"(12,7)	D	R	B	L	Z
E147.222.R	G147.222.R	22,2	6,4	14	60	2
E147.254.R	G147.254.R	25,4	8	14	60	2
E147.286.R	G147.286.R	28,6	9,5	14	62	2
E147.350.R	G147.350.R	35	12,7	17	64	2
E147.410.R	G147.410.R	41	16	18	65	2

Z050.001.N

Z053.001.N

Z054.001.N

Z051.001.R

S Ø 12	S Ø 1/2"(12,7)	D	R	B	L	Z
E147.570.R	G147.570.R	57	22	32	81	2

Z050.003.N

Z053.003.N

Z054.002.N

Z051.002.R

SLOT CUTTER ARBORS

ART. E117 - G117

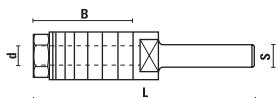

Used with cutters Art. A118 - C118, spacers Art. Z057 and ball bearing Art. Z050 (see section 10)



S Ø 12	S Ø 12,7 (1/2")	d	B	L
E117.120.N	G117.120.R	7,94	53	96
E117.121.N	G117.121.R	7,94	66	108
E117.122.N	G117.122.R	7,94	38	80
E117.123.N	G117.123.R	7,94	38	80

SLOT CUTTER ARBORS

ART. A117 - B117 - C117 - E117 - G117

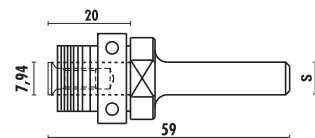

S Ø 12	S Ø 1/2" (12,7)
E117.280.R	G117.280.R
With ball bearing	
Z050.008.N	Z051.015.R
	nr. 2 - Z057.002.N - 1 mm nr. 2 - Z057.003.N - 0,5 mm nr. 5 - Z057.004.N - 0,1 mm nr. 2 - Z057.005.N - 3 mm

Change the ball bearing to get different cutting depths (see page 10.05)

S Ø 12	S Ø 1/2" (12,7)
E117.281.R	G117.281.R
Without ball bearing	
Z051.015.R	nr. 3 - Z057.002.N - 1 mm nr. 2 - Z057.003.N - 0,5 mm nr. 6 - Z057.004.N - 0,1 mm nr. 2 - Z057.005.N - 3 mm nr. 1 - Z057.006.N - 6 mm

HW SLOT CUTTERS Z=2

ART. C118

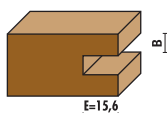
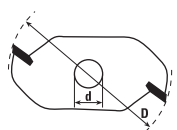

Item	d	D	B	Z
C118.216.R	7,94	47,6	1,6	2
C118.220.R	7,94	47,6	2	2
C118.224.R	7,94	47,6	2,4	2
C118.230.R	7,94	47,6	3	2
C118.232.R	7,94	47,6	3,2	2
C118.240.R	7,94	47,6	4	2
C118.248.R	7,94	47,6	4,8	2
C118.250.R	7,94	47,6	5	2
C118.260.R	7,94	47,6	6	2
C118.264.R	7,94	47,6	6,4	2

HW SLOT CUTTERS Z=3

ART. C118

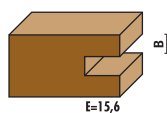
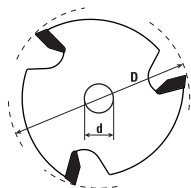

Item	d	D	B	Z
C118.316.R	7,94	47,6	1,6	3
C118.320.R	7,94	47,6	2	3
C118.324.R	7,94	47,6	2,4	3
C118.330.R	7,94	47,6	3	3
C118.332.R	7,94	47,6	3,2	3
C118.340.R	7,94	47,6	4	3
C118.348.R	7,94	47,6	4,8	3
C118.350.R	7,94	47,6	5	3
C118.360.R	7,94	47,6	6	3
C118.364.R	7,94	47,6	6,4	3

HW SLOT CUTTERS SPECIAL FIXING SCREW Z=3

ART. C118

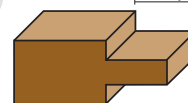
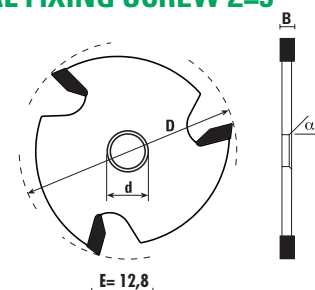

- To be used with slot cutter arbors
- $\alpha = 45^\circ$ bore

Item	d	D	B	Z
C118.830.R	7,94	47,6	3	3
C118.832.R	7,94	47,6	3,2	3
C118.840.R	7,94	47,6	4	3
C118.848.R	7,94	47,6	4,8	3
C118.850.R	7,94	47,6	5	3
C118.860.R	7,94	47,6	6	3
C118.864.R	7,94	47,6	6,4	3

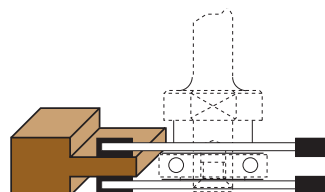

Example of processing:
The fixing screw (Art. Z051.015.R) used on this spindle has a special head angle that allows it to remain flat on the cutter level.



SLOT CUTTER ARBORS WITH SHANK 6 (1/4") AND 8 MM

ART. A117 - B117 - C117 at page 1.13

HW FLUSH TRIM BITS WITH BALL BEARING GUIDE Z=2

ART. E146 - G146

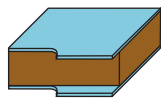
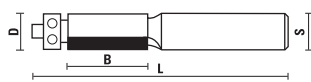

S Ø 12	S Ø 1/2" (12,7)	D	B	L
E146.126.R	G146.126.R	12,7	13	71
E146.127.R	G146.127.R	12,7	25	84
E146.128.R	G146.128.R	12,7	38	98
E146.129.R	G146.129.R	12,7	51	106



Z050.003.N



Z053.003.N



Z054.002.N



Z051.002.R

S Ø 12	S Ø 1/2" (12,7)	D	B	L
E146.190.R	G146.190.R	19	25	82
E146.191.R	G146.191.R shear angle	19	38	98
E146.192.R	G146.192.R shear angle	19	51	108



Z050.005.N



Z053.002.N



Z054.002.N



Z051.004.R

HW FLUSH TRIM BITS WITH UPPER AND LOWER BALL BEARING Z=2

ART. E146 - G146

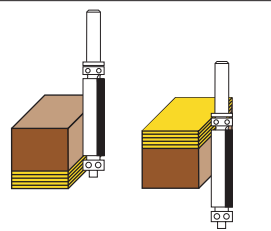
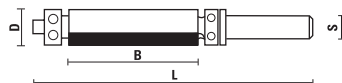

- Suitable for trimming with template on the upper and/or lower side
- Klein® trimming bits with straight cut are suitable for smooth and well-finished edges on melamine and veneered panels.

S Ø 12	S Ø 1/2" (12,7)	D	B	L
E146.592.R	G146.592.R	19	51	108



Z050.005.N
(upper ball bearing)



Z050.012.N
(lower ball bearing)



Z053.002.N



Z054.002.N



Z051.004.N



Z058.002.N



SOLID CARBIDE COMPRESSION CUTTERS Z=2+2 WITH DOUBLE BALL BEARING

ART. T166

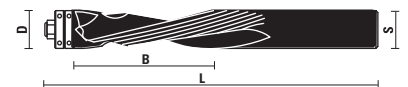

Excellent finish on both upper and lower side



- Right-hand rotation with double flute compression spiral (UP & DOWN).
- Double ball bearings guide for greater precision of trimming
- Special spiral geometry which provides better chip evacuation and smoother cuts on laminate panels.



S Ø 12	D	B	L	Z
T166.120.R NEW	12	51	110	2+2



Z050.031.N

VHW FLUSH TRIM BITS WITH DOUBLE BALL BEARINGS Z=2

ART. T168

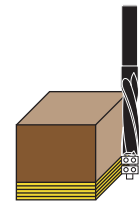

- Solid carbide (VHW)
- Right-hand rotation with "UP CUT SPIRAL"
- Double ball bearings guide for **greater precision of trimming**
- Special spiral geometry which provides **better chip evacuation and smoother cuts** compared to standard flush trim bits
- For natural wood, pressed wood, veneered, laminate and melamine

S Ø 12	D	B	L	Z
T168.127.R	12,7 (1/2")	51	125	2



Z050.007.N

HW INSERT FLUSH TRIMMING BITS Z=2

ART. W114 - WG114

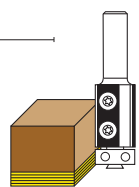
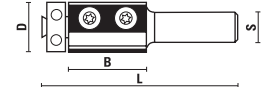

- Lower ball bearing
- This item is sold complete with a torx key

S Ø 12	D	B	L	Z
W114.190.R	19	30	80	2
W114.191.R	19	50	100	2

S Ø 1/2" (12,7)	D	B	L	Z
WG114.190.R	19	30	80	2
WG114.191.R	19	50	100	2



Z555.008.N
(B=30)



Z555.010.N
(B=50)



Z052.201.N



Z051.017.R
(for ball bearing)



Z050.006.N
(D=19)



Z051.010.R
(for knives)

HW INSERT FLUSH TRIMMING BITS Z=2

ART. W116 - WG116

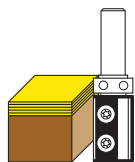
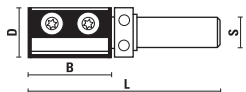

- Upper ball bearing
- This item is sold complete with a torx key



S Ø 12	D	B	L	Z
W116.190.R	19	30	80	2
W116.191.R	19	50	100	2

S Ø 1/2" (12,7)	D	B	L	Z
WG116.190.R	19	30	80	2
WG116.191.R	19	50	100	2

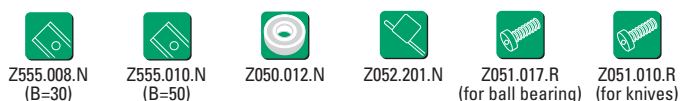

HW INSERT FLUSH TRIMMING BITS WITH UPPER AND LOWER BALL BEARINGS Z=2

ART. W118 - WG118

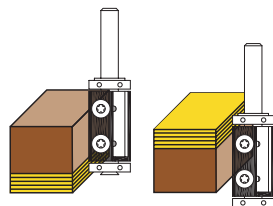
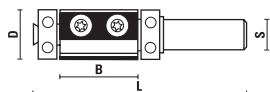

- Suitable for trimming with template on the upper and/or lower side
- This item is sold complete with a torx key



S Ø 12	D	B	L	Z
W118.191.R	19	50	110	2

S Ø 1/2" (12,7)	D	B	L	Z
WG118.191.R	19	50	105	2



HW SPOILBOARD BITS Z=6

ART. E350 - G350

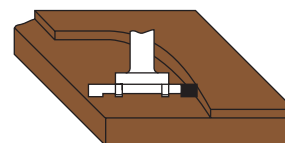
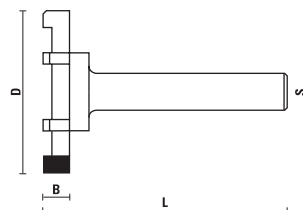

- Used for surfacing MDF, wood and particle board and making deep rabbet
- Suitable for processing ever kind of wood



S Ø 12	S Ø 1/2" (12,7)	D	B	L	Z
E350.521.R	G350.521.R	52	6,5	83	6

HW INSERT ROUTER BITS FOR PLANING AND RABBETING Z=3

ART. WE190 - WG190

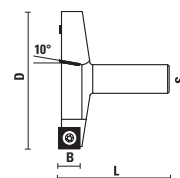

10° shear angle

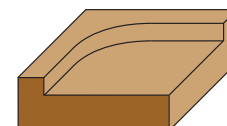

- Used for surfacing MDF, wood and particle board and making deep rabbet
- 10° shear angle for better performance
- Suitable for processing ever kind of wood
- For greater performance PCD knives can be mounted
- This item is sold complete with a torx key



S Ø 12	D	B	L	Z
WE190.380.R NEW	38	12	60	3
Z051.210.R	Z555.001.N	Z052.201.N		

S Ø 12	D	B	L	Z
WE190.635.R	63,5 (2-1/2")	14	70 (2-3/4")	3
Z051.210.R	Z555.007.N	Z052.201.N		

S Ø 1/2" (12,7)	D	B	L	Z
WG190.635.R	2-1/2"	14	2-3/4"	3
Z051.020.R	Z555.007.N	Z052.103.N		

HW RABBETING BITS WITH BALL BEARING GUIDE Z=2

ART. E150 - G150

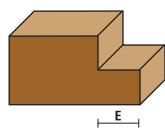
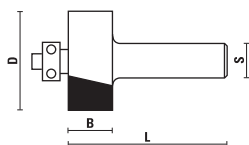

S Ø 12	S Ø 1/2" (12,7)	D	B	E	L
E150.320.R	G150.320.R	32	13	9,5	60
E150.350.R	G150.350.R	35	13	11	60

SET

E150.850.R	G150.850.R	35	13	8-9,5-11-12,7	60
------------	------------	----	----	---------------	----



Z050.002.N (E=12,7)
Z050.003.N (E=11)
Z050.004.N (E=9,5)
Z050.023.N (E=8)



Z053.002.N
Z053.003.N
Z053.004.N



Z051.002.R

Art. E150.850.R/G150.850.R

Supplied with ball bearing set for different thickness rebates

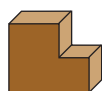

8
Z050.023.R

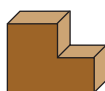

9,5
Z050.004.R

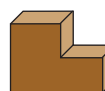

11
Z050.003.R

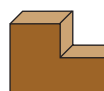

12,7
Z050.002.R

Scale 1:2

HW INSERT RABBETING BITS Z=2

ART. WE150

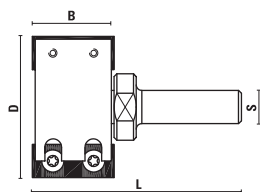

- Suitable for working with FESTOOL® CMS-OF 1010/ BASIS 5A/BASIS 6
- To be used with FESTOOL® Compact Modular System (CMS)
- This item is sold complete with a torx key

S Ø 12	D	B	L	Z
WE150.500.R	50	30	70	2

SPARE PARTS

Rabbeting head

WE150.505.R	50	30	2
-------------	----	----	---

Cutter arbor

E117.130.N	S= Ø12x36
------------	-----------



Z051.010.R



Z052.201.N



Z055.110.N

ASSEMBLY



WE150.505.R
Rabbeting head

+



E117.130.R
Cutter arbor

=

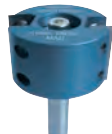

WE150.500.R

HW RABBETING BITS WITH BALL BEARING GUIDE Z=2

ART. E150 - G150

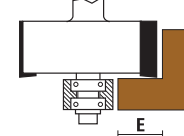
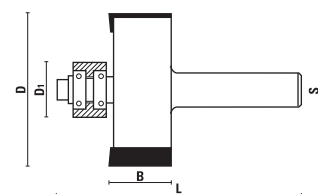

- Changing guide rings several thickness rebates 1,6 up to 18,25 mm can be obtained
- This item is sold complete with a guide collar D=19 mm (our item Z050.903.N) to obtain rabbet width of E=16 mm.

S Ø 12	S Ø 1/2" (12,7)	D	D1	B	E	L
E150.510.R	G150.510.R	51	19	22,5	16	78



Z050.007.N



Z057.010.N



Z051.008.R

Spare rings

	D1	E
Z050.901.N	14,3	18,25
Z050.902.N	16	17,5
Z050.903.N	19	16
Z050.904.N	20,6	15,2
Z050.905.N	22,2	14,3
Z050.906.N	25,4	12,7
Z050.907.N	27	12
Z050.908.N	28,6	11,1
Z050.909.N	31,8	9,5
Z050.910.N	32,5	9,25
Z050.911.N	35	8
Z050.912.N	38	6,4
Z050.913.N	39	6
Z050.914.N	41,3	4,8
Z050.915.N	44,4	3,2
Z050.916.N	47,6	1,6

Z050.999.N 16 rings set

HW BEVEL TRIM BITS WITH BALL BEARING GUIDE Z=2

ART. E151 - G151

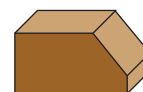
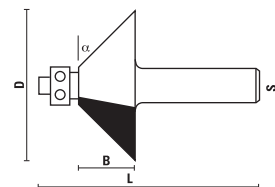

S Ø 12	S Ø 1/2" (12,7)	D	α	B	L
E151.351.R	G151.351.R	35	60°	20,6	60
E151.508.R	G151.508.R	50,8	45°	19	68
E151.635.R	G151.635.R	60,5	45°	25	74



Z050.003.N



Z053.003.N



Z054.002.N



Z051.002.R

HW CORNER ROUNDING BITS WITH BALL BEARING GUIDE Z=2

ART. E152 - G152

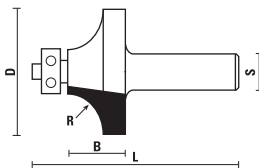

S Ø 12	S Ø 1/2" (12,7)	D	R	B	L
E152.191.R	G152.191.R	19,1	3,2	9,5	59
E152.207.R	G152.207.R	20,7	4	10	59
E152.220.R	G152.220.R	22	5	13	62
E152.254.R	G152.254.R	25,4	6,4	13	62
E152.286.R	G152.286.R	28,6	8	14	62
E152.318.R	G152.318.R	31,8	9,5	16	65
E152.327.R		32,7	10	16	65
E152.367.R		36,7	12	20	67
E152.380.R	G152.380.R	38	12,7	19	67
E152.410.R	G152.410.R*	41	14	20	70
E152.427.R		42,7	15	22	70
E152.445.R	G152.445.R	44,5	16	22,2	71
E152.487.R		48,7	18	26	72
E152.508.R	G152.508.R	50,8	19	25,4	73
E152.527.R		52,7	20	27	73
E152.570.R	G152.570.R	57	22	29	78
E152.635.R	G152.635.R	63,5	25	32	81
E152.700.R	G152.700.R - max RPM 18.000	70	28	35	84
E152.726.R		72,6	30	36	85
E152.760.R	G152.760.R - max RPM 18.000	76	32	38	87
E152.825.R		82,5	35	41	90
E152.890.R	G152.890.R - max RPM 16.000	89	38	45	94

* Selling out

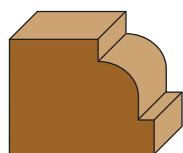

Changing the ball bearing art. **Z050.003.N** with art. **Z050.002.N** the profile shown can be obtained

HW CLASSICAL BITS WITH BALL BEARING GUIDE Z=2

ART. E153

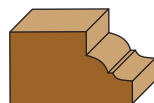
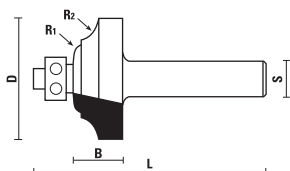

S Ø 12	D	R1	R2	B	L
E153.381.R	38,1	5,5	6	15,9	63,5



HW OGEE BITS WITH BALL BEARING GUIDE Z=2

ART. E154 - G154

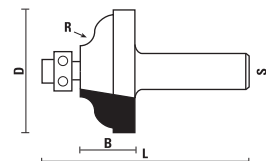

S Ø 12	S Ø 1/2" (12,7)	D	R	B	L
E154.350.R*		35	4	13	61
E154.413.R	G154.413.R	41,3	6,4	19	67
E154.570.R*		57	9,5	25	75

* Selling out



HW MOULDING BITS WITH BALL BEARING GUIDE Z=2

ART. E156 - G156

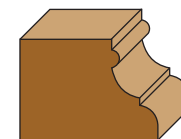
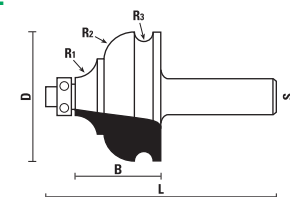

S Ø 12	S Ø 1/2" (12,7)	D	R1	R2	R3	B	L
E156.413.R	G156.413.R	41,3	6,4	9,5	3,2	28,5	75,5



HW MOULDING BITS WITH BALL BEARING GUIDE Z=2

ART. E157 - G157

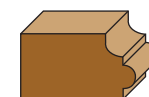
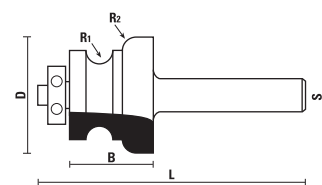

S Ø 12	S Ø 1/2" (12,7)	D	R1	R2	B	L
E157.400.R	G157.400.R	40	5,5	6	30	78



HW MOULDING BITS WITH BALL BEARING GUIDE Z=2

ART. E158 - G158

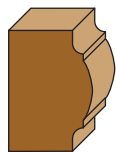
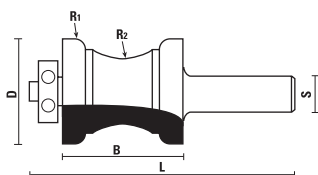

S Ø 12	S Ø 1/2" (12,7)	D	R1	R2	B	L
E158.350.R	G158.350.R	35	5	13	40	88
Z050.004.N	Z053.004.N		Z054.002.N		Z051.002.R	

HW ROMAN OGEE BITS WITH BALL BEARING GUIDE Z=2

ART. E148 - G148

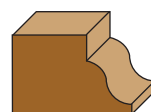
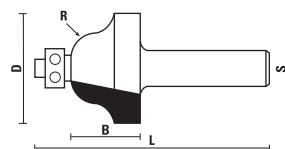

S Ø 12	S Ø 1/2" (12,7)	D	R	B	L
E148.254.R	G148.254.R	25,4	4	16	63
E148.350.R	G148.350.R	35	6,4	20	67
Z050.001.N	Z053.001.N	Z054.001.N	Z051.001.R		

HW DRAWING LINE BITS WITH BALL BEARING GUIDE Z=2

ART. E160

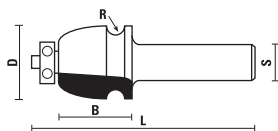

S Ø 12	D	R	B	L
E160.260.R Selling out	26	3,5	25	74
Z050.003.N	Z053.003.N	Z054.002.N	Z051.002.R	

HW CLASSICAL OGEE BITS WITH BALL BEARING GUIDE Z=2

ART. E149 - G149

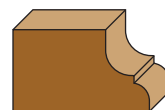
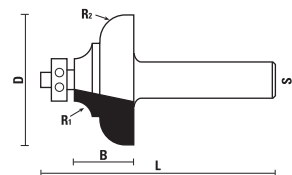

S Ø 12	S Ø 1/2" (12,7)	D	R1	R2	B	L
E149.286.R	G149.286.R	28,6	4	4	13	60
E149.350.R	G149.350.R	35	6	4,8	18	64
E149.380.R* Selling out		38	4,7	8	16	65
E149.510.R	G149.510.R	51	9,5	9,5	23	72
Z050.003.N	Z053.003.N	Z054.002.N	Z051.002.R			

HW DRAWING LINE BITS WITH BALL BEARING GUIDE Z=2

ART. E161 - G161

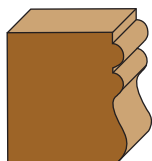
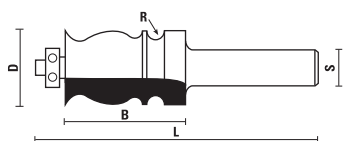

S Ø 12	S Ø 1/2" (12,7)	D	R	B	L
E161.254.R	G161.254.R	25,4	3,5	45	94
Z050.003.N	Z053.003.N	Z054.002.N	Z051.002.R		

HW ARCHITECTURAL MOULDING LINE BITS WITH BALL BEARING GUIDE Z=2

ART. E162 - G162

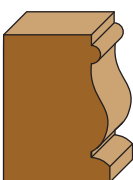
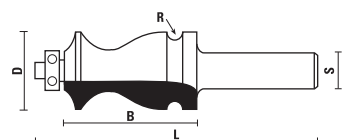

S Ø 12	S Ø 1/2" (12,7)	D	R	B	L
E162.270.R	G162.270.R	27	3	45	94
Z050.003.N	Z053.003.N	Z054.002.N	Z051.002.R		

HW ARCHITECTURAL MOULDING LINE BITS WITH BALL BEARING GUIDE Z=2

ART. E163 - G163

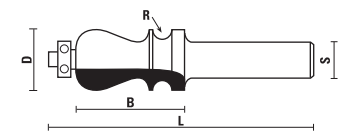

S Ø 12	S Ø 1/2" (12,7)	D	R	B	L
E163.220.R	G163.220.R	22	4	38	87
Z050.003.N	Z053.003.N	Z054.002.N	Z051.002.R		

HW MULTI RADIUS BITS Z=2

ART. E165 - G165

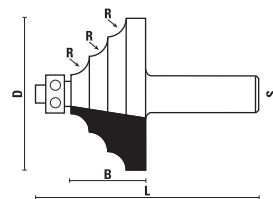

S Ø 12	S Ø 1/2" (12,7)	D	R	B	L
E165.470.R	G165.470.R	47	6	24	73
Z050.003.N	Z053.003.N	Z054.002.N	Z051.002.R		

HW MULTIPLE PROFILE BITS Z=2

ART. E166 - G166

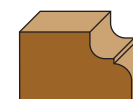
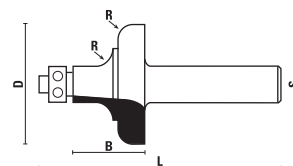

S Ø 12	S Ø 1/2" (12,7)	D	R	B	L
E166.510.R	G166.510.R	51	8,5	31	80
Z050.003.N	Z053.003.N	Z054.002.N	Z051.002.R		

HW MULTIPLE PROFILE BITS Z=2

ART. E167 - G167

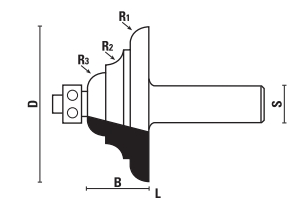

S Ø 12	S Ø 1/2" (12,7)	D	R1	R2	R3	B	L
E167.590.R	G167.590.R	59	6,5	6,5	7,5	22	70
Z050.003.N	Z053.003.N	Z054.002.N	Z051.002.R				

HW MULTIPLE PROFILE BITS Z=2

ART. E168 - G168

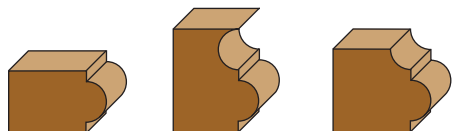
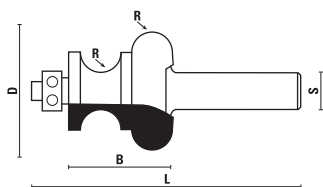

S Ø 12	S Ø 1/2"(12,7)	D	R	B	L
E168.510.R	G168.510.R	51	6,4	32	80
Z050.004.N	Z053.004.N	Z054.002.N	Z051.002.R		

HW BEADING BITS FOR RADIUS WINDOW Z=2

ART. E199 - C199

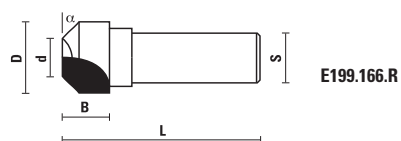
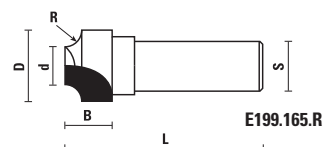
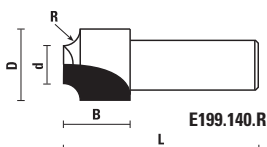
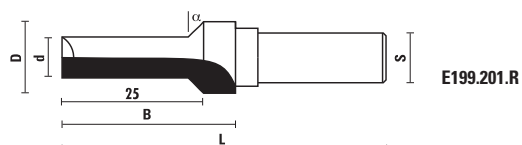
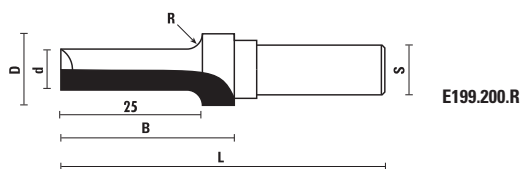
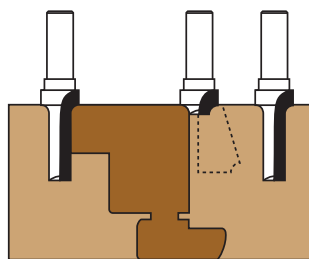

- To use on "ARKADE + ZINKEL" or on similar equipment
 - Bits for glass-fixing lath see item Art. T141.061.R (HW)
 and Art. U211.061.R (HS)

S Ø 12	S Ø 8	D	d	R	α	B	L
E199.140.R	C199.140.R	14	6	3	16	46	
E199.165.R	C199.165.R	16,5	8,5	3	11	46	
E199.166.R		16,5	8,5		45°	11	46
E199.200.R	C199.200.R	20	12	3	33	68	
E199.201.R	C199.201.R	20	12		45°	33	68

HW CLASSICAL MULTI-FORM BITS WITH BALL BEARING GUIDE Z=2

ART. E169 - G169

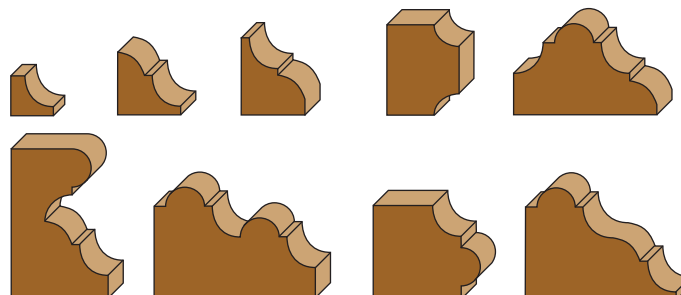
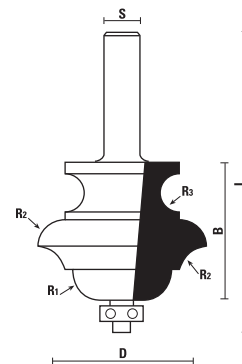

S Ø 12	S Ø 1/2"(12,7)	D	R1	R2	R3	B	L
E169.540.R	G169.540.R	54	9	8,5	6,4	47	96
		max RPM 18.000					
Z050.003.N	Z053.003.N	Z054.002.N	Z051.002.R				

HW HANDRAIL BITS WITH BALL BEARING GUIDE Z=2

ART. E170 - G170

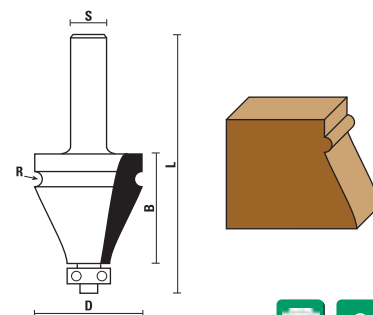

S Ø 12	S Ø 1/2"(12,7)	D	R	B	L
E170.350.R	G170.350.R	35	3,2	37	86
Z050.003.N	Z053.003.N	Z054.002.N	Z051.002.R		

SAMPLE OF HANDRAIL PATTERNS

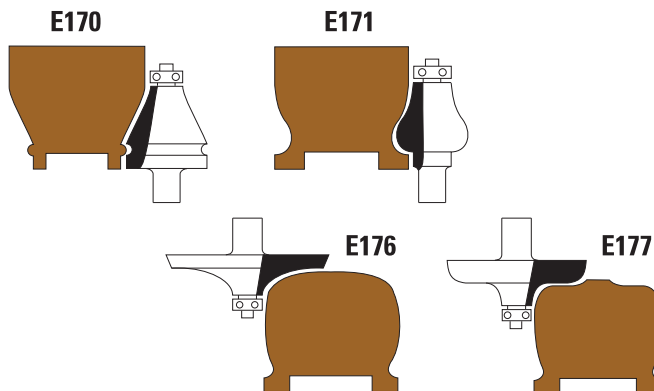

HW HANDRAIL BITS WITH BALL BEARING GUIDE Z=2

ART. E171 - G171

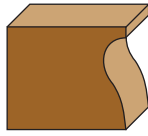
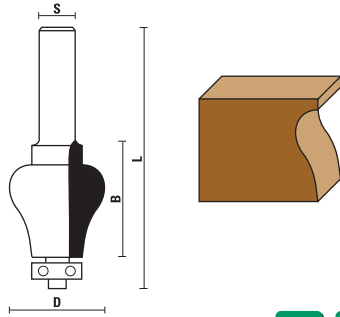

S Ø 12	S Ø 1/2"(12,7)	D	R	B
E171.320.R	G171.320.R	32	38	87



Z050.003.N



Z053.003.N



Z054.002.N



Z051.002.R

HW EDGE BEADING BITS Z=2

ART. E172 - G172

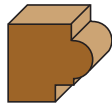
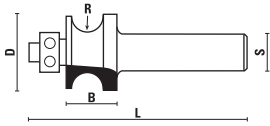

S Ø 12	S Ø 1/2"(12,7)	D	R	B	L
E172.220.R	G172.220.R	22	3,2	14	63
E172.280.R	G172.280.R	28	4,8	16	66
E172.320.R	G172.320.R	32	6,4	19	67
E172.380.R	G172.380.R	38	9,5	25	74



Z050.004.N



Z053.004.N



Z054.002.N



Z051.002.R

HW HANDRAIL AND TABLE EDGE BITS Z=2

ART. E173 - G173

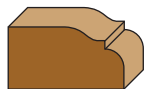
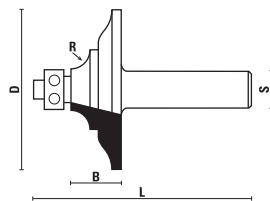

S Ø 12	S Ø 1/2"(12,7)	D	R	B	L
E173.640.R	G173.640.R - max RPM 18.000	64	6,5	20	69



Z050.003.N



Z053.003.N



Z054.002.N



Z051.002.R

HW HANDRAIL AND TABLE EDGE BITS Z=2

ART. E174 - E174

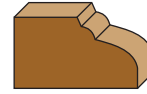
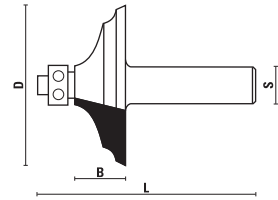

S Ø 12	S Ø 1/2"(12,7)	D	B	L
E174.660.R	G174.660.R - max RPM 18.000	66	20	69



Z050.003.N



Z053.003.N



Z054.002.N



Z051.002.R

HW RAISED PANEL BITS WITH BALL BEARING GUIDE Z=2

ART. E175 - E175

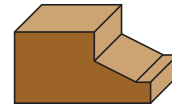
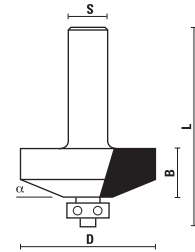

S Ø 12	S Ø 1/2"(12,7)	D	α	B	L
E175.420.R	G175.420.R	42	25°	13	62



Z050.003.N



Z053.003.N



Z054.002.N



Z051.002.R

HW HANDRAIL-TABLE EDGE BITS WITH BALL BEARING GUIDE Z=2

ART. E176 - G176

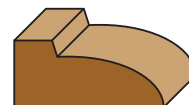
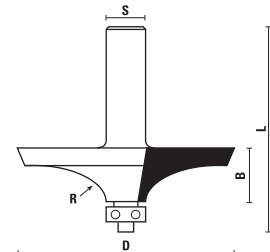

S Ø 12	S Ø 1/2"(12,7)	D	R	B	L
E176.690.R	G176.690.R - max RPM 18.000	69	43	16	64



Z050.003.N



Z053.003.N



Z054.002.N



Z051.002.R

HW HANDRAIL-TABLE EDGE BITS WITH BALL BEARING GUIDE Z=2

ART. E177 - G177

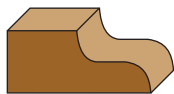
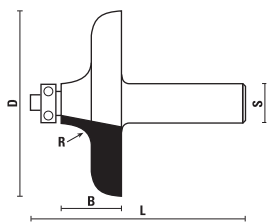

S Ø 12	S Ø 1/2" (12,7)	D	R	B	L
E177.640.R	G177.640.R - max RPM 18.000	64	9,5	20	69
Z050.003.N	Z053.003.N	Z054.002.N	Z051.002.R		

HW RAISED PANEL BITS WITH BALL BEARING GUIDE Z=2

ART. E178 - G178

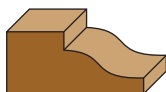
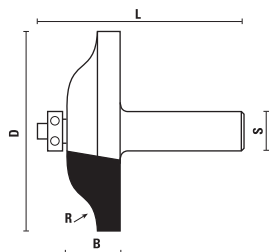
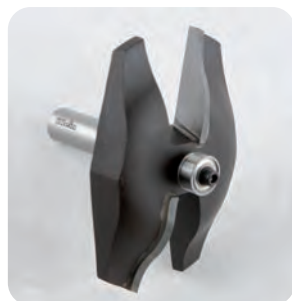

S Ø 12	S Ø 1/2" (12,7)	D	R	B	L
E178.670.R	G178.670.R - max RPM 18.000	67	19	17	65
E178.860.R	G178.860.R - max RPM 16.000	86	22	16	65
Z050.003.N	Z053.003.N	Z054.002.N	Z051.002.R		

HW RAISED PANEL BITS WITH BALL BEARING GUIDE Z=2

ART. E178 - G178

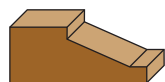
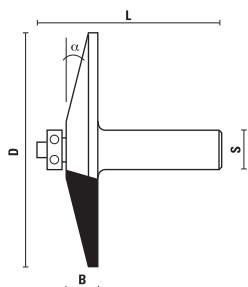

S Ø 12	S Ø 1/2" (12,7)	D	α	B	L
E178.861.R	G178.861.R - max RPM 16.000	86	15°	13	61
Z050.003.N	Z053.003.N	Z054.002.N	Z051.002.R		

HW RAISED PANEL BITS WITH BALL BEARING GUIDE Z=2

ART. E178 - G178

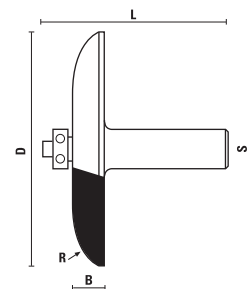

S Ø 12	S Ø 1/2" (12,7)	D	R	B	L
E178.862.R	G178.862.R - max RPM 16.000	86	40	13	61
Z050.003.N	Z053.003.N	Z054.002.N	Z051.002.R		

HW RAISED PANEL BITS WITH BALL BEARING GUIDE Z=2

ART. E179 - G179

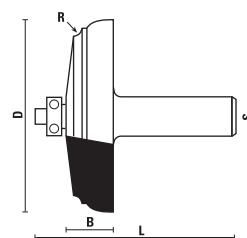

S Ø 12	S Ø 1/2" (12,7)	D	R	B	L
E179.640.R	G179.640.R - max RPM 18.000	64	3	13	62
Z050.003.N	Z053.003.N	Z054.002.N	Z051.002.R		

HW FINGER JOINT ASSEMBLY WITH BALL BEARING GUIDE Z=2

ART. E180 - G180

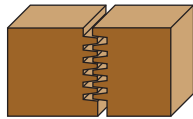
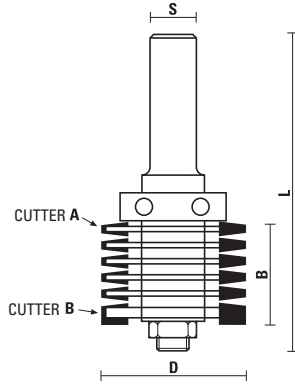

Working height 11 to 36 mm

S Ø 12	S Ø 1/2"(12,7)	D	B	L	Z
E180.397.R	G180.397.R	39,7	36	96	2

SPARE PARTS

Arbor

S Ø 12	S Ø 1/2"(12,7)
E117.120.R	G117.120.R

Finger cutter "A" (5 pcs.) Ø 39,2 x 1,85 d=8 Z=2
C180.500.R

Straight cutter "B" (1 pcs.) Ø 39,7 x 5,5 d=8 Z=2
C180.501.R



Z050.010.N



Z057.001.N - 6 pcs.



Z057.002.N - 2 pcs.
Z057.003.N - 1 pcs.
Z057.004.N - 10 pcs.

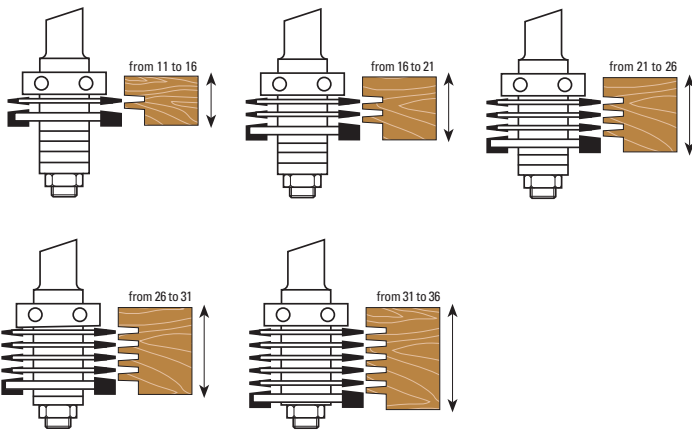

HW FINGER JOINT ASSEMBLY WITH BALL BEARING GUIDE Z=3

ART. E181 - G181

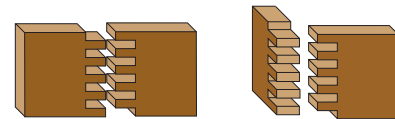
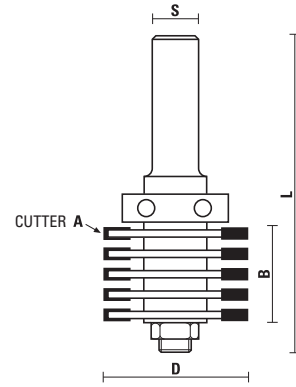

- Working height 22 to 45 mm
- Supplied with nr. 3 ball bearings for producing nr. 3 different cutting depths (E=9,8 - E=9,3 - E=6,8)

S Ø 12	S Ø 1/2"(12,7)	D	B	L	Z	E
E181.476.R	G181.476.R	47,6	36	96	3	9,8

SPARE PARTS

Arbor

S Ø 12	S Ø 1/2"(12,7)
E117.120.R	G117.120.R

Finger cutter "A" (5 pcs.) Ø 47,6 x 4 d=8 Z=3
C118.340.R



Z050.107.N - 1 pcs.
Z050.108.N - 1 pcs.
Z050.109.N - 1 pcs.



Z057.009.N - 4 pcs.



Z057.004.N - 4 pcs.
Z057.008.N - 8 pcs.

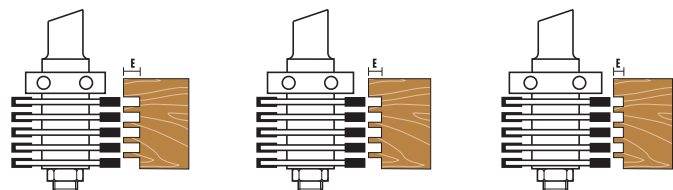

Z050.107.N
Ball bearing Ø28
E=9,8

Z050.108.N
Ball bearing Ø29
E=9,3

Z050.109.N
Ball bearing Ø34
E=6,8

HW SLOT CUTTER SET WITH BALL BEARING GUIDE Z=2

ART. E182 - G182

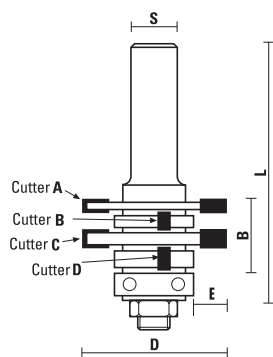

- For groovings 3,2 mm up to 18 mm
- Some possible combinations to obtain different measures of grooves
- Adding or removing the spacers included in the kit, can be obtained more measures (see drawing)



S Ø 12	S Ø 1/2"(12,7)	D	B	L	Z	E
E182.476.R	G182.476.R	47,6	3,2÷18	76	2	12,8

SPARE PARTS

Arbor

S Ø 12	S Ø 1/2"(12,7)
E117.123.R	G117.123.R

Cutter (4 pcs.)

"A" - C118.232.R	Ø 47,6 x 3,2	d=8	Z=2
"B" - C118.240.R	Ø 47,6 x 4	d=8	Z=2
"C" - C118.248.R	Ø 47,6 x 4,8	d=8	Z=2
"D" - C118.264.R	Ø 47,6 x 6,4	d=8	Z=2



Z050.008.N - 1 pcs.



Z057.006.N - 3 pcs.
Z057.002.N - 5 pcs.



Z057.003.N - 5 pcs.
Z057.004.N - 10 pcs.

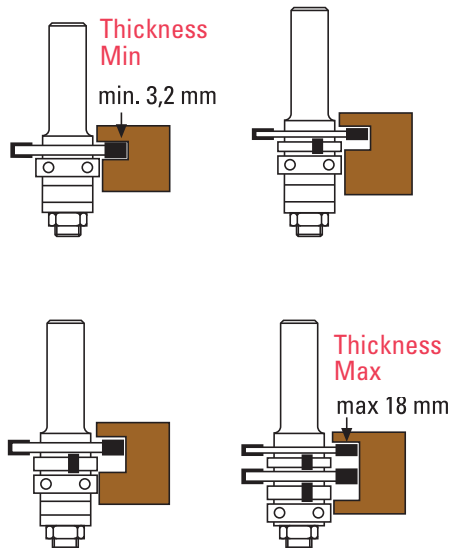

HW DOUBLE CORNER ROUND ASSEMBLY WITH BALL BEARING GUIDE Z=3

ART. E186 - G186 - C186

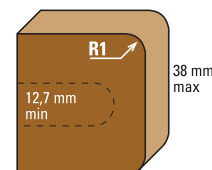
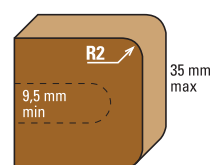
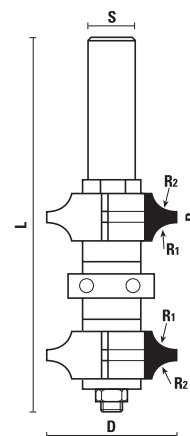

- R2 = 4,8 mm (working height 9,5 to 35 mm)
- R1 = 6,4 mm (working height 12,7 to 38 mm)



S Ø 12	S Ø 1/2"(12,7)	S Ø 8	D	R1	R2	B	L
E186.350.R	G186.350.R	C186.350.R	35	6,4	4,8	14	108

SPARE PARTS

Arbor

S Ø 12	S Ø 1/2"(12,7)	S Ø 8
E117.121.R	G117.121.R	C117.081.R

Top cutter Ø 35/Ø 8 Z=3 R1=6,4 R2=4,8
C186.500.R

Bottom cutter Ø 35/Ø 8 Z=3 R1=6,4 R2=4,8
C186.501.R



Z050.008.N - 1 pcs.



Z057.002.N - 2 pcs.
Z057.005.N - 2 pcs.
Z057.006.N - 2 pcs.



Z057.003.N - 1 pcs.
Z057.004.N - 4 pcs.

HW DOUBLE CHAMFER ASSEMBLY WITH BALL BEARING GUIDE Z=3

ART. E187 - G187 - C187

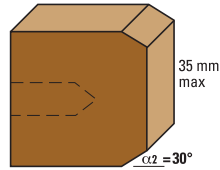
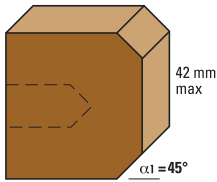
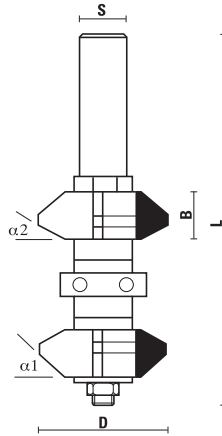

- $\alpha_1 = 45^\circ$ (Working height 0 to 42 mm)
- $\alpha_2 = 30^\circ$ (Working height 0 to 35 mm)



S Ø 12	S Ø 1/2" (12,7)	S Ø 8	D	B	α_1	α_2	L
E187.350.R	G187.350.R	C187.350.R	35	14	45°	30°	108

SPARE PARTS

Arbor

S Ø 12	S Ø 1/2" (12,7)	S Ø 8
E117.121.R	G117.121.R	C117.081.R

Top cutter	Ø 35/Ø 8	Z=3	$\alpha_1=45^\circ$	$\alpha_2=30^\circ$
C187.500.R				

Bottom cutter	Ø 35/Ø 8	Z=3	$\alpha_1=45^\circ$	$\alpha_2=30^\circ$
C187.501.R				



Z050.008.N - 1 pcs.



Z057.002.N - 3 pcs.
Z057.005.N - 2 pcs.
Z057.006.N - 2 pcs.



Z057.003.N - 1 pcs.
Z057.004.N - 4 pcs.

HW BEAD PANELING ASSEMBLY WITH BALL BEARING GUIDE Z=2

ART. E188 - G188 - C188

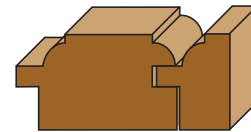
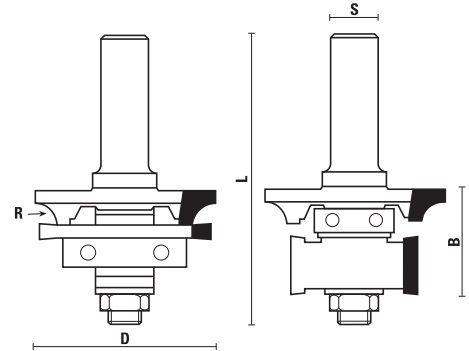

S Ø 12	S Ø 1/2" (12,7)	S Ø 8	D	R	B	L
E188.490.R	G188.490.R	C188.490.R	49	6	30	80

SPARE PARTS

Arbor

S Ø 12	S Ø 1/2" (12,7)	S Ø 8
E117.122.R	G117.122.R	C117.082.R

Profile cutter	Ø 49 x 9	d=8	Z=2
C188.500.R			

Grooving cutter	Ø 46 x 4	d=8	Z=2
C188.501.R			

Rabbeting cutter	Ø 33,5 x 17,5	d=8	Z=2
C188.502.R			



Z050.008.N - 1 pcs.
Z050.016.N - 1 pcs.



Z057.002.N - 2 pcs.
Z057.005.N - 3 pcs.



Z057.003.N - 1 pcs.
Z057.007.N - 1 pcs.
Z057.004.N - 3 pcs.
Z057.008.N - 1 pcs.

HW V PANELING ASSEMBLY WITH BALL BEARING GUIDE Z=2

ART. E189 - G189 - C189

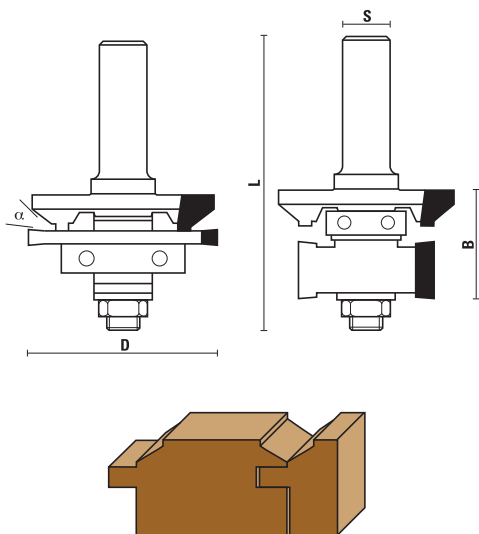

S Ø 12	S Ø 1/2"(12,7)	S Ø 8	D	α	B	L
E189.425.R	G189.425.R	C189.425.R	42,5	45°	30	80

SPARE PARTS

Arbor

S Ø 12	S Ø 1/2"(12,7)	S Ø 8
E117.122.R	G117.122.R	C117.082.R

Profile cutter 45°	Ø 42,5 x 9	d=8	Z=2
C189.500.R			

Grooving cutter	Ø 46 x 4	d=8	Z=2
C188.501.R			

Rabbeting cutter	Ø 33,5 x 17,5	d=8	Z=2
C188.502.R			



Z050.008.N - 1 pcs.
Z050.016.N - 1 pcs.



Z057.002.N - 2 pcs.
Z057.005.N - 3 pcs.



Z057.003.N - 1 pcs.
Z057.007.N - 1 pcs.
Z057.004.N - 3 pcs.
Z057.008.N - 1 pcs.

HW OGEE WINDOW SASH ASSEMBLY WITH BALL BEARING GUIDE Z=2

ART. E191 - G191 - C191

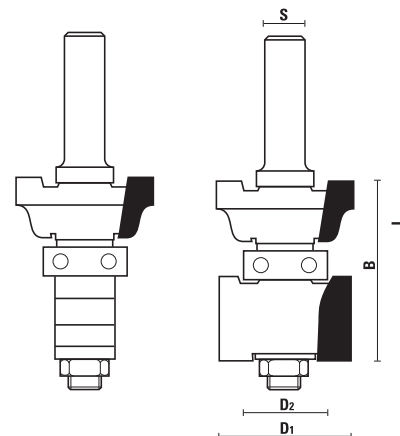

S Ø 12	S Ø 1/2"(12,7)	S Ø 8	D1	D2	B	L
E191.350.R	G191.350.R	C191.350.R	35	22	47	96

SPARE PARTS

Arbor

S Ø 12	S Ø 1/2"(12,7)	S Ø 8
E117.120.R	G117.120.R	C117.080.R

Profile cutter	Ø 35 x 17	d=8	Z=2
C191.500.R			

Rabbeting cutter	Ø 35 x 22	d=8	Z=2
C191.501.R			



Z050.008.N - 1 pcs.



Z057.005.N - 1 pcs.
Z057.006.N - 3 pcs.



Z057.003.N - 1 pcs.
Z057.004.N - 3 pcs.
Z057.008.N - 1 pcs.

HW TONGUE AND GROOVE ASSEMBLY WITH BALL BEARING GUIDE Z=2

ART. E193 - G193 - C193

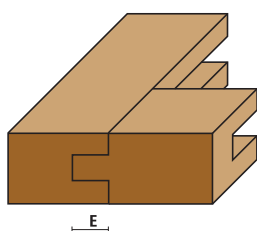
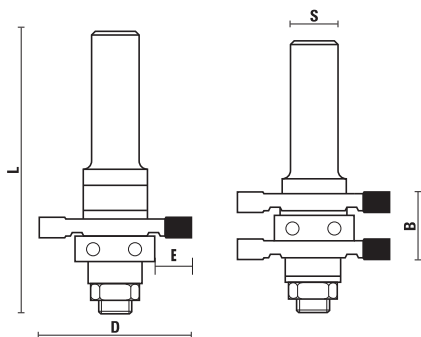

S Ø 12	S Ø 1/2"(12,7)	S Ø 8	D	B	L	E
E193.410.R	G193.410.R		41	19	76	9,5
		C193.410.R	41	19	70	9,5

SPARE PARTS

Arbor

S Ø 12	S Ø 1/2"(12,7)	S Ø 8
E117.123.R	G117.123.R	C117.079.R

Grooving cutter (2 pcs.) Ø 41 x 6,4 d=8 Z=2
C193.500.R



Z050.008.N - 1 pcs.



Z057.002.N - 1 pcs.
Z057.006.N - 2 pcs.



Z057.004.N - 4 pcs.
Z057.008.N - 2 pcs.

HW STILE AND RAIL ASSEMBLY WITH BALL BEARING GUIDE Z=2

ART. E194 - G194 - C194

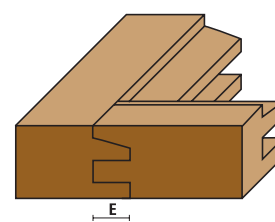
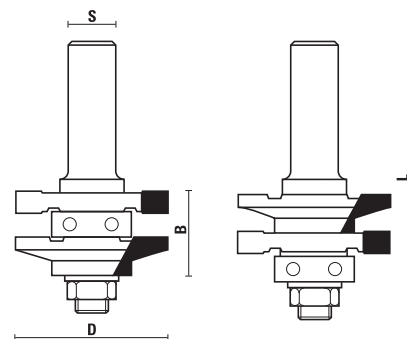

S Ø 12	S Ø 1/2"(12,7)	S Ø 8	D	B	L	E
E194.410.R	G194.410.R		41	22	76	9,5
		C194.410.R	41	22	70	9,5

SPARE PARTS

Arbor

S Ø 12	S Ø 1/2"(12,7)	S Ø 8
E117.123.R	G117.123.R	C117.079.R

Profile cutter Ø 41 x 11 d=8 Z=2
C194.500.R

Grooving cutter Ø 41 x 6,4 d=8 Z=2
C193.500.R



Z050.008.N - 1 pcs.



Z057.004.N - 3 pcs.
Z057.008.N - 1 pcs.

HW STILE AND RAIL ASSEMBLY WITH BALL BEARING GUIDE Z=2

ART. E195 - G195 - C195

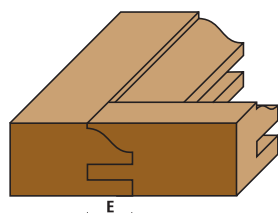
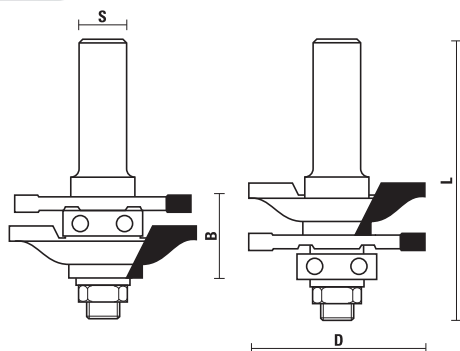

S Ø 12	S Ø 1/2"(12,7)	S Ø 8	D	B	L	E
E195.460.R	G195.460.R		46	22	76	12
		C195.460.R	46	22	70	12

SPARE PARTS

Arbor

S Ø 12	S Ø 1/2"(12,7)	S Ø 8
E117.123.R	G117.123.R	C117.079.R

Profile cutter	Ø 46 x 15	d=8	Z=2
C195.500.R			

Grooving cutter	Ø 46 x 4	d=8	Z=2
C188.501.R			



Z050.008.N - 1 pcs.



Z057.004.N - 3 pcs.
Z057.008.N - 1 pcs.

HW STILE AND RAIL ASSEMBLY WITH BALL BEARING GUIDE Z=2

ART. E196 - G196 - C196

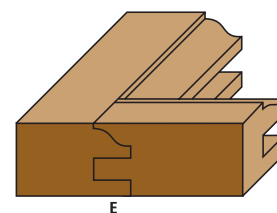
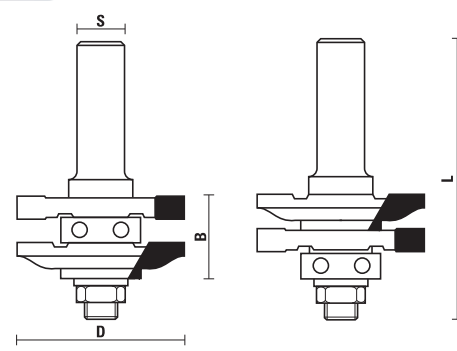

S Ø 12	S Ø 1/2"(12,7)	S Ø 8	D	B	L	E
E196.410.R	G196.410.R		41	22	76	9,5
		C196.410.R	41	22	70	9,5

SPARE PARTS

Arbor

S Ø 12	S Ø 1/2"(12,7)	S Ø 8
E117.123.R	G117.123.R	C117.079.R

Profile cutter	Ø 41 x 11	d=8	Z=2
C196.500.R			

Grooving cutter	Ø 41 x 6,4	d=8	Z=2
C193.500.R			



Z050.008.N - 1 pcs.



Z057.004.N - 2 pcs.
Z057.008.N - 2 pcs.

HW STILE AND RAIL ASSEMBLY WITH BALL BEARING GUIDE Z=2

ART. E197 - G197 - C197

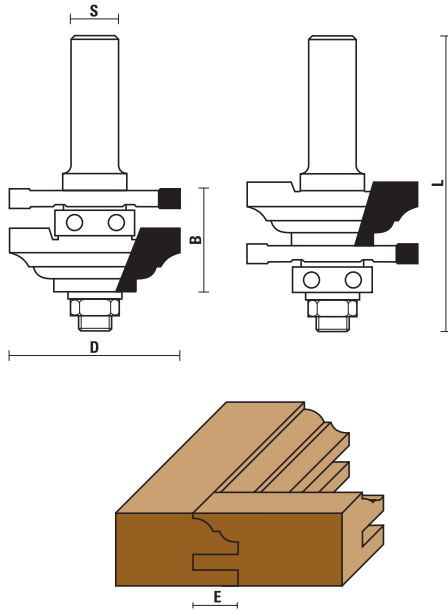

S Ø 12	S Ø 1/2"(12,7)	S Ø 8	D	B	L	E
E197.460.R	G197.460.R		46	22	76	12
		C197.460.R	46	22	70	12

SPARE PARTS

Arbor

S Ø 12	S Ø 1/2"(12,7)	S Ø 8
E117.123.R	G117.123.R	C117.079.R

Profile cutter Ø 46 x 15 d=8 Z=2
C197.500.R

Grooving cutter Ø 46 x 4 d=8 Z=2
C188.501.R



Z050.008.N - 1 pcs.



Z057.004.N - 2 pcs.
Z057.008.N - 2 pcs.

HW STILE AND RAIL ASSEMBLY WITH BALL BEARING GUIDE Z=2

ART. E198 - G198 - C198

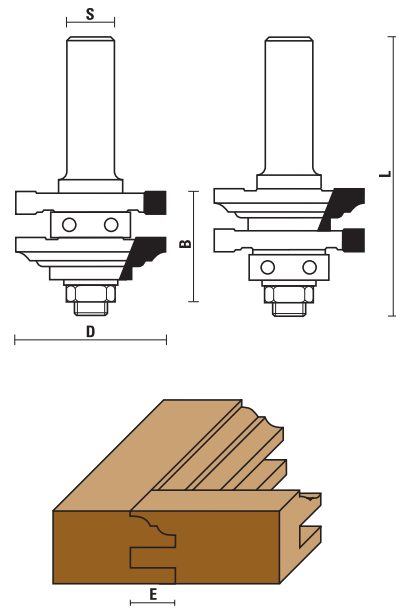

S Ø 12	S Ø 1/2"(12,7)	S Ø 8	D	B	L	E
E198.410.R	G198.410.R		41	22	76	9,5
		C198.410.R	41	22	70	9,5

SPARE PARTS

Arbor

S Ø 12	S Ø 1/2"(12,7)	S Ø 8
E117.123.R	G117.123.R	C117.079.R

Profile cutter Ø 41 x 11 d=8 Z=2
C198.500.R

Grooving cutter Ø 41 x 6,4 d=8 Z=2
C193.500.R



Z050.008.N - 1 pcs.



Z057.004.N - 2 pcs.
Z057.008.N - 2 pcs.

2 PIECE SET FOR CABINET DOORS MAKER "TYPE 1"

ART. X021

- Set including stile and rail bit, raised panel bit.

- Practical plastic case.

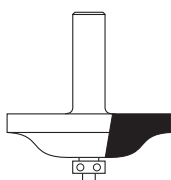

E178.860.R

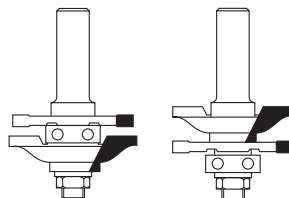

E195.460.R

S Ø 12

X021.012.R

2-pcs router bit set:

E178.860.R

E195.460.R

S Ø 1/2"(12,7)

X021.127.R

2-pcs router bit set:

G178.860.R

G195.460.R

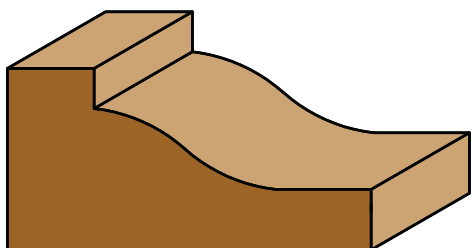

E178.860.R

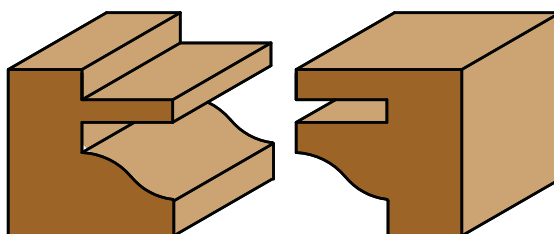

E195.460.R

Scale 1:1

2 PIECE SET FOR CABINET DOORS MAKER "TYPE 2"

ART. X022

- Set including stile and rail bit, raised panel bit.

- Practical plastic case.

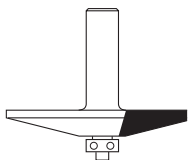

E178.861.R

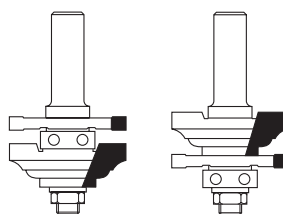

E197.460.R

S Ø 12

X022.012.R

2-pcs router bit set:

E178.861.R

E197.460.R

S Ø 1/2"(12,7)

X022.127.R

2-pcs router bit set:

G178.861.R

G197.460.R

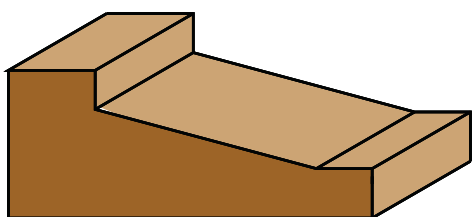

E178.861.R

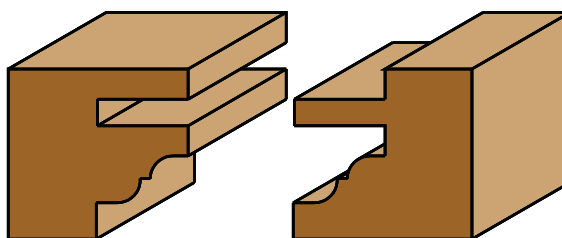

E197.460.R

Scale 1:1

2 PIECE SET FOR CABINET DOORS MAKER "TYPE 3"

ART. X023

- Set including stile and rail bit, raised panel bit.
- Practical plastic case.

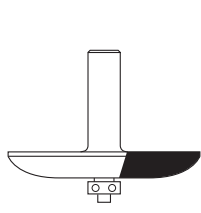

E178.862.R

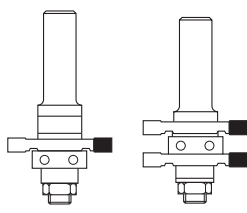

E193.410.R

S Ø 12

S Ø 1/2"(12,7)

X023.012.R

X023.127.R

2-pcs router bit set:

2-pcs router bit set:

E178.862.R

G178.862.R

E193.410.R

G193.410.R

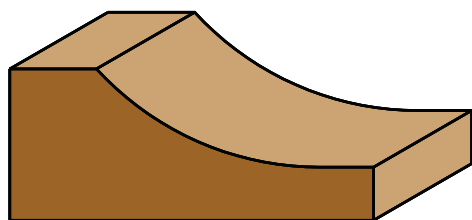

E178.862.R

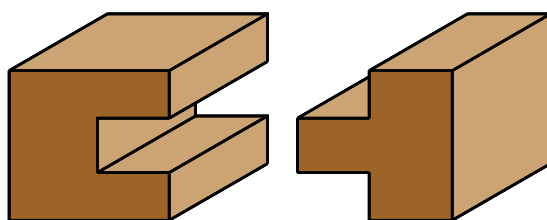

E193.410.R

Scale 1:1

3 PIECE SET FOR CABINET DOORS MAKER AND JOINTS "TYPE 1"

ART. X024

- Set including stile and rail bit, raised panel bit and slot cutter.
- Practical plastic case.

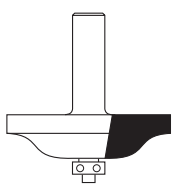

E178.860.R

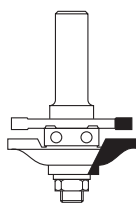

E195.460.R



E182.476.R

S Ø 12

S Ø 1/2"(12,7)

X024.012.R

X024.127.R

3-pcs router bit set:

3-pcs router bit set:

E178.860.R

G178.860.R

E195.460.R

G195.460.R

E182.476.R

G182.476.R

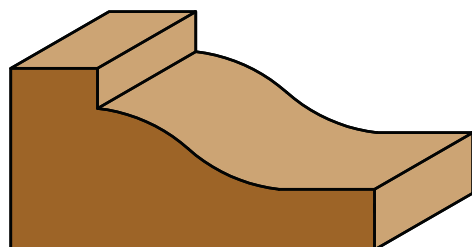

E178.860.R

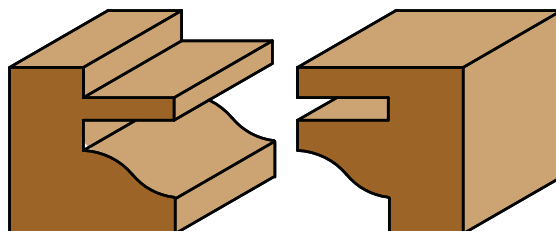

E195.460.R

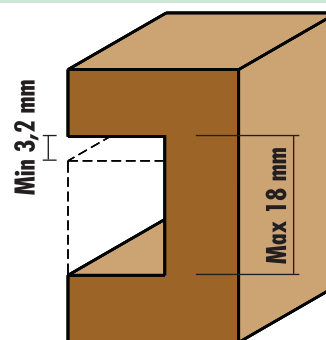

E182.476.R

Scale 1:1

3 PIECE SET FOR CABINET DOORS MAKER AND JOINTS "TYPE 2"

ART. X025

- Set including stile and rail bit, raised panel bit and slot cutter.
- Practical plastic case.

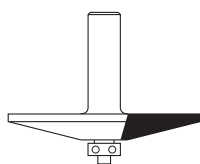

E178.861.R

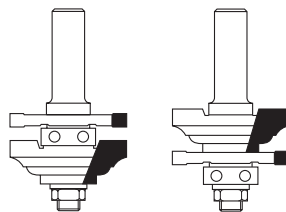

E197.460.R



E182.476.R

S Ø 12

X025.012.R

3-pcs router bit set:

E178.861.R

E197.460.R

E182.476.R

S Ø 1/2"(12,7)

X025.127.R

3-pcs router bit set:

G178.861.R

G197.460.R

G182.476.R

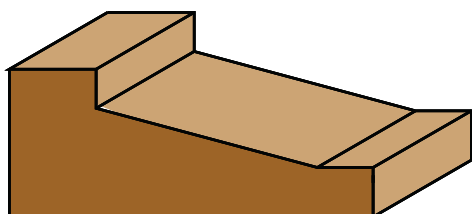

E178.861.R

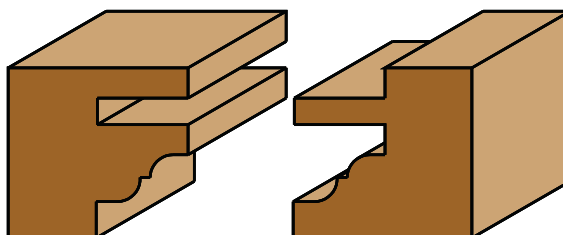

E197.460.R

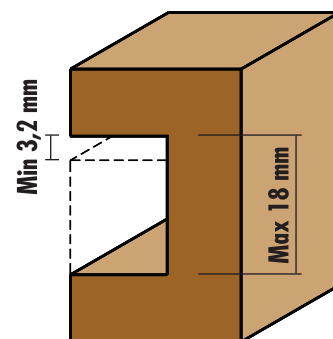

E182.476.R Scale 1:1

3 PIECE SET FOR CABINET DOORS MAKER AND JOINTS "TYPE 3"

ART. X026

- Set including stile and rail bit, raised panel bit and slot cutter.
- Practical plastic case.

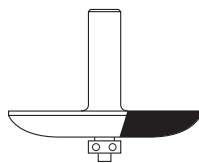

E178.862.R

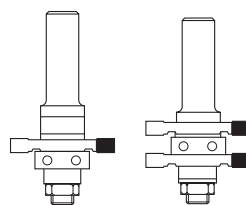

E193.410.R



E182.476.R

S Ø 12

X026.012.R

3-pcs router bit set:

E178.862.R

E193.410.R

E182.476.R

S Ø 1/2"(12,7)

X026.127.R

3-pcs router bit set:

G178.862.R

G193.410.R

G182.476.R

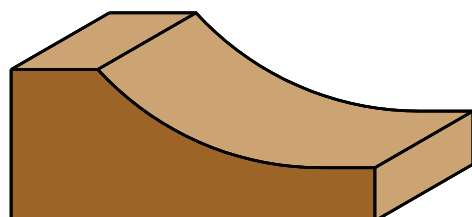

E178.862.R

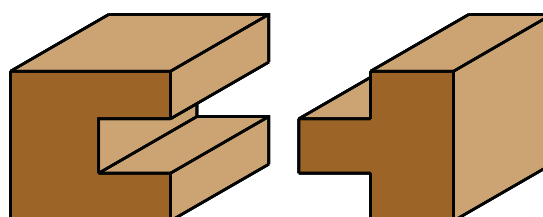

E193.410.R

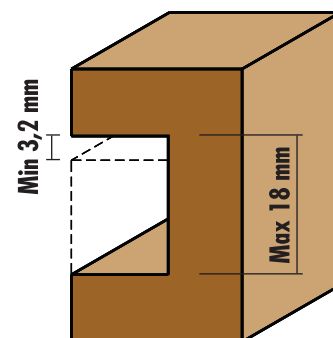

E182.476.R Scale 1:1

ROUTER BITS FOR WOOD, CHIPBOARDS AND SOLID SURFACE MATERIALS



HW ROUTER BITS WITH NEGATIVE AXIAL ANGLE Z=2
Page 3.05



HW STRAIGHT PLUNGE BITS Z=1
Page 3.05



HW STRAIGHT PLUNGE BITS WITH BALL BEARING GUIDE Z=2
Page 3.05



HW FACE-INLAY BITS WITH BALL BEARING GUIDE Z=2
Page 3.05



HW FLUSH TRIM BITS WITH BALL BEARING GUIDE Z=2
Page 3.06

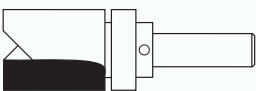

HW FLUSH TRIM BITS WITH UPPER BALL BEARING GUIDE Z=2
Page 3.06



HW TOPMOUNT ROUTER BITS Z=2
Page 3.06



HW BEVEL HOLE ROUTER BITS Z=3
Page 3.06



HW BEVEL UNDERMOUNT BITS WITH BALL BEARING GUIDE Z=2
Page 3.06

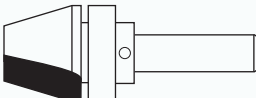

HW TOPMOUNT COUNTERTOP BITS WITH UPPER BALL BEARING GUIDE Z=2
Page 3.06

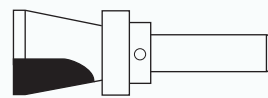

HW TOPMOUNT COUNTERTOP BITS WITH UPPER BALL BEARING GUIDE Z=2
Page 3.07

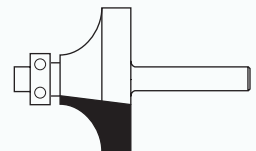

HW CORNER ROUNDING BITS WITH DELRIN® BALL BEARING GUIDE Z=2
Page 3.07

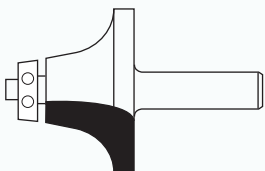

HW ROUNDOVER BITS WITH BALL BEARING GUIDE Z=2
Page 3.07

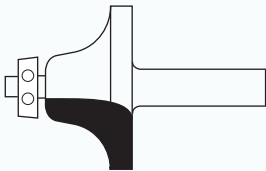

HW OGEE BITS WITH BALL BEARING GUIDE Z=2
Page 3.07



HW COUNTER-TOP BITS WITH BALL BEARING GUIDE Z=2
Page 3.07

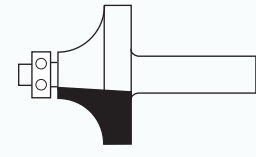

HW CORNER ROUNDING BITS WITH BALL BEARING GUIDE Z=2
Page 3.08

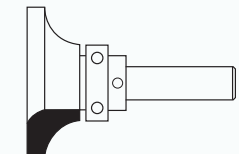

HW ROUNDING-UNDER BITS WITH UPPER BALL BEARING GUIDE Z=2
Page 3.08

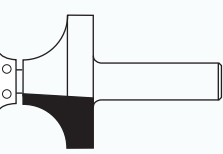

HW CORNER-ROUNDING BITS WITH BALL BEARING GUIDE Z=2
Page 3.08

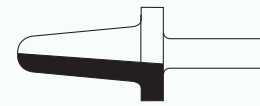

HW UPSTAND BITS Z=2
Page 3.08

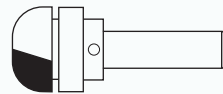

HW COVE BITS WITH UPPER BALL BEARING GUIDE Z=2
Page 3.09

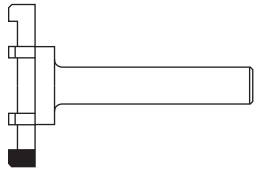

HW BOWL AND COUNTERTOP TRIM BITS Z=2
Page 3.09



HW PROFILE BITS Z=2
Page 3.09

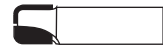

HW PROFILE BITS Z=2
Page 3.09

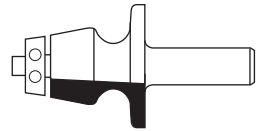

HW UNDERMOUNT PROFILE BOWL BITS WITH BALL BEARING GUIDE Z=2
Page 3.09

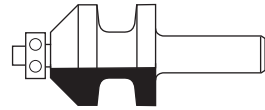

HW BEVEL HOB BITS WITH BALL BEARING GUIDE Z=2
Page 3.09

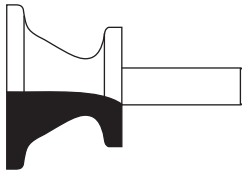

HW BEADING BITS Z=2
Page 3.10



HW TRIPLE BEADING BITS WITH BALL BEARING GUIDE Z=2
Page 3.10

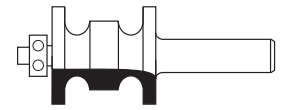

HW DOUBLE BEADING BITS WITH BALL BEARING GUIDE Z=2
Page 3.10

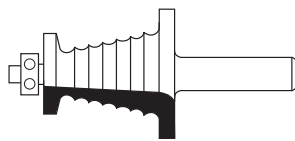

HW MULTI BEADING BITS WITH BALL BEARING GUIDE Z=2
Page 3.10

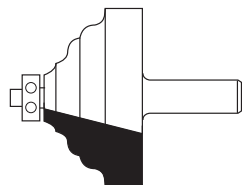

HW EDGE Moulding BITS WITH BALL BEARING GUIDE Z=2
Page 3.10

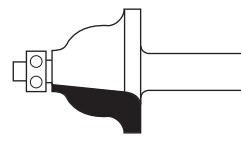

HW WAVY EDGE BITS WITH BALL BEARING GUIDE Z=2
Page 3.10

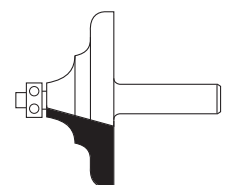

HW EDGE Moulding BITS WITH BALL BEARING GUIDE Z=2
Page 3.11



HW ROMAN OGEE BITS WITH BALL BEARING GUIDE Z=2
Page 3.11

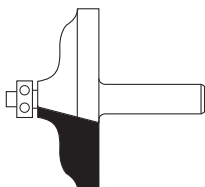

HW EDGE Moulding BITS WITH BALL BEARING GUIDE Z=2
Page 3.11

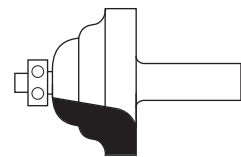

HW EDGE Moulding BITS WITH BALL BEARING GUIDE Z=2
Page 3.11

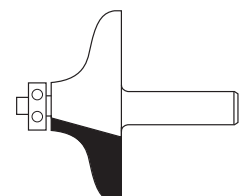

HW EDGE Moulding BITS WITH BALL BEARING GUIDE Z=2
Page 3.11

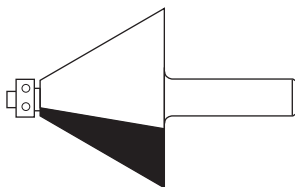

HW BEVEL BITS WITH BALL BEARING GUIDE Z=2
Page 3.11

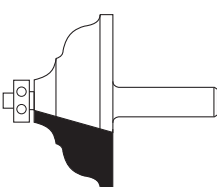

HW EDGE Moulding BITS WITH BALL BEARING GUIDE Z=2
Page 3.12

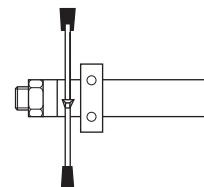

HW ROUTER BITS FOR SINK REPAIRING
Page 3.12

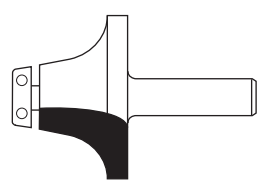

HW ROUNDING OVER UNDERMOUNT BOWL BITS WITH BALL BEARING GUIDE Z=2
Page 3.12



HW ROUNDING OVER UNDERMOUNT BOWL BITS WITH BALL BEARING GUIDE Z=2
Page 3.12



INSERT FLUSH TRIM BITS Z=2
Page 3.12



INSERT FLUSH TRIM BITS Z=2
Page 3.12



HW/HS STRAIGHT PLUNGE CUTTING BITS FOR "ELU" Z=2
Page 3.13



HW STRAIGHT PLUNGE CUTTING BITS FOR "ELU" Z=2
Page 3.13



HW STRAIGHT PLUNGE CUTTING BITS FOR "SCHEER" Z=2
Page 3.13



HW STRAIGHT PLUNGE CUTTING BITS FOR "SCHEER" Z=2
Page 3.13



HW DRILL BITS FOR "FESTOOL" MACHINES Z=2
Page 3.14

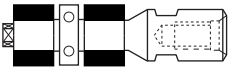

HW FLUSH TRIMMING BITS
WITH BALL BEARING GUIDE Z=2
Page 3.14

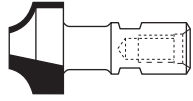

HW RADIUS BITS Z=2
Page 3.14

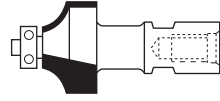

HW RADIUS BITS WITH
BALL BEARING GUIDE Z=2
Page 3.14



HW RADIUS BITS Z=2
Page 3.14

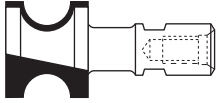

HW RADIUS BITS Z=2
Page 3.14

ROUTER BITS FOR WORKING SOLID SURFACE MATERIALS

HW router bits for working solid surface are manufactured by Sistemi Klein® with high quality raw materials, softer cutting angles and the use of carefully selected Delrin bearings to allow safe and optimal processing of solid surfaces and to decorate Corian®, Avonite®, Hanex® and more. Nowadays, working and routing "Solid Surface" material is more and more common. Solid Surface such as Corian®, Avonite®, Hanex®... are largely used in many different fields, both domestic (bathrooms, kitchens and labs) and health (hospital and clinics). It is a useful, versatile and easy to clean product. All the Klein router bits for working solid surface are developed and made with a special solid carbide for cutting these sturdy materials. The soft form of our cutting angles and the Delrin® ball bearings, allow safe and easy operations.

HW ROUTER BITS WITH NEGATIVE AXIAL ANGLE Z=2

ART. E300 - G300

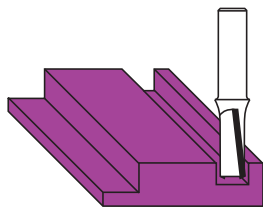
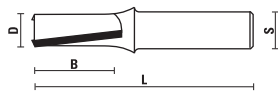

S Ø 12	S Ø 1/2" (12,7)	D	B	L
E300.095.R	G300.095.R	9,5	25	70
E300.127.R	G300.127.R	12,7	32	73
E300.128.R	G300.128.R	12,7	38	79
E300.129.R	G300.129.R	12,7	50	107,5

HW STRAIGHT PLUNGE BITS Z=1

ART. E301 - G301

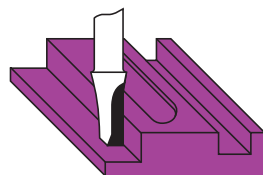
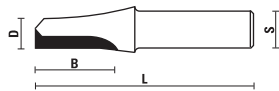

S Ø 12	S Ø 1/2" (12,7)	D	B	L
E301.095.R	G301.095.R	9,5	25	70

HW STRAIGHT PLUNGE BITS WITH BALL BEARING GUIDE Z=2

ART. E302 - G302

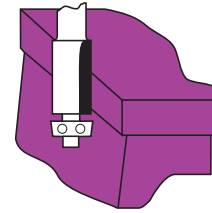
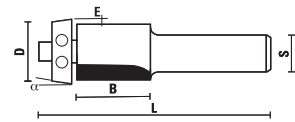

5° ball bearing with Delrin® ring

S Ø 12	S Ø 1/2" (12,7)	D	B	L	α	E
E302.190.R	G302.190.R	19	25	82,5	5°	1,6
Z050.103.N	Z053.002.N	Z051.004.R				

S Ø 12	D	B	L	α
E302.191.R	19	25,4	80	0°
Z050.101.N	Z053.002.N	Z051.004.R		

HW FACE-INLAY BITS WITH BALL BEARING GUIDE Z=2

ART. E305 - E306 - E307

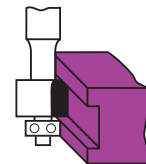
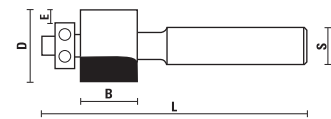

S Ø 12	D	B	L	E
E305.127.R Selling out	22	12,7	82	4,8
Z050.007.N	Z054.003.N	Z051.004.R		

S Ø 12	D	B	L	E
E306.064.R Selling out	22	6,4	76	3,2
E306.127.R	22	12,7	82	3,2
Z050.011.N	Z054.003.N	Z051.004.R		

S Ø 12	D	B	L	E
E307.127.R Selling out	22	12,7	82	1,6
Z050.005.N	Z054.003.N	Z051.004.R		

HW FLUSH TRIM BITS WITH BALL BEARING GUIDE Z=2

ART. E310 - G310

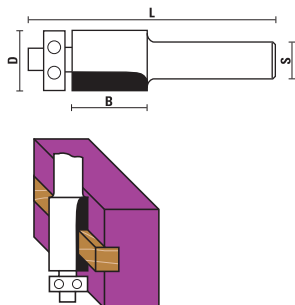

S Ø 12	S Ø 1/2" (12,7)	D	B	L
E310.190.R	G310.190.R	19	25	82
Z050.101.N	Z053.002.N	Z051.004.R		

HW FLUSH TRIM BITS WITH UPPER BALL BEARING GUIDE Z=2

ART. E312 - G312

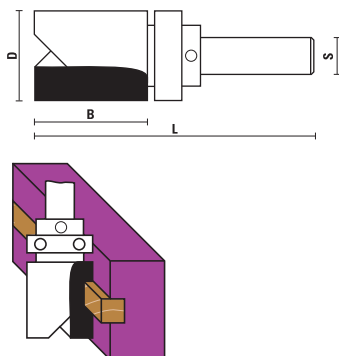

S Ø 12	S Ø 1/2" (12,7)	D	B	L
E312.286.R	G312.286.R	28,6	38	92
Z050.015.N	Z058.003.N	Z051.005.R		

HW TOPMOUNT ROUTER BITS Z=2

ART. E315

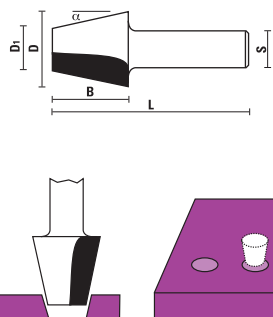

S Ø 12	D	D ₁	B	L	α
E315.240.R	23	12,3	25	63,1	15°
E315.340.R	34	23,3	25	63,1	15°
E315.450.R	45	34,3	25	63,1	15°

HW BEVEL HOLE ROUTER BITS Z=3

ART. E315

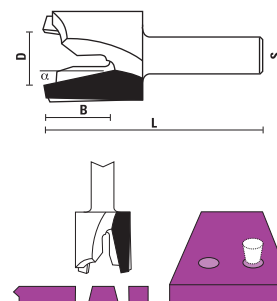

S Ø 12	D	B	L	α
E315.730.R	23	20	72	15°
E315.840.R	34	20	72	15°
E315.950.R	45	20	72	15°

HW BEVEL UNDERMOUNT BITS WITH BALL BEARING GUIDE Z=2

ART. E316 - G316

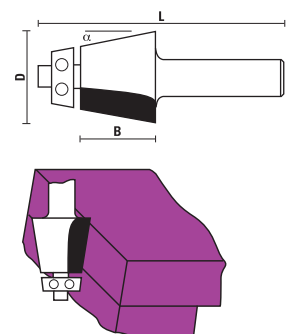

12° ball bearing with Delrin® ring

S Ø 12	S Ø 1/2" (12,7)	D	B	L	α
E316.320.R	G316.320.R	32	25	81	12°
Z050.106.N	Z053.002.N	Z051.007.R			

S Ø 12	S Ø 1/2" (12,7)	D	B	L	α
E316.390.R	G316.390.R	39	32	78	12°
Z050.106.N	Z053.002.N	Z051.007.R			

HW TOPMOUNT COUNTERTOP BITS WITH UPPER BALL BEARING GUIDE Z=2

ART. E317 - G317

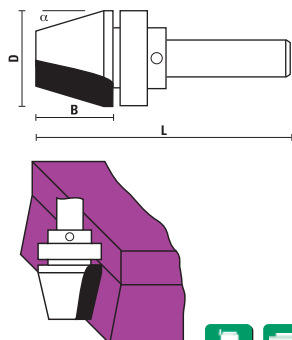

S Ø 12	S Ø 1/2" (12,7)	D	B	L	α
E317.286.R	G317.286.R	28,6	25	78	12°
Z050.015.N	Z058.003.N	Z051.005.R			

HW TOPMOUNT COUNTERTOP BITS WITH UPPER BALL BEARING GUIDE Z=2

ART. E321

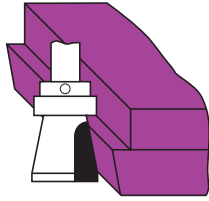
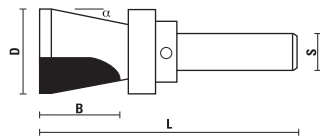

S Ø 12	D	B	L	α
E321.286.R	28,6	26	79	12°



Z050.015.N



Z058.003.N



Z051.005.R

HW CORNER ROUNDING BITS WITH DELRIN® BALL BEARING GUIDE Z=2

ART. C323

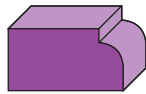
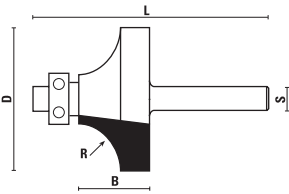

- Complete with Delrin® ball bearing to avoid marking and scratches
- Suitable for working composite material

S Ø 8	D	R	B	L
C323.167.R	16,7	2	8	47
C323.187.R	18,7	3	9,5	49
C323.190.R	19	3,2	10	48
C323.222.R	22,2	4,8	13	51
C323.254.R	25,4	6,4	13	51
C323.286.R	28,6	8	13	51
C323.318.R	31,8	9,5	16	56
C323.354.R	35,4	11	17	57
C323.380.R	38	12,7	19	57



Z050.100.N



Z054.002.N



Z051.002.R

HW ROUNDROVER BITS WITH BALL BEARING GUIDE Z=2

ART. E325 - G325

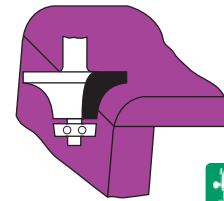
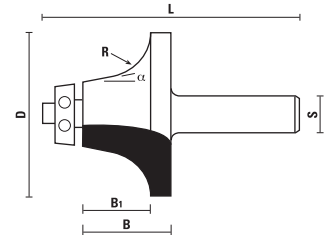

18° ball bearing with Delrin® ring

S Ø 12	S Ø 1/2" (12,7)	D	B	B1	L	R	α
E325.540.R	G325.540.R	54	25	19	79	12,7	18°
E325.570.R	G325.570.R	57	32	25	83	14	18°



Z050.102.N



Z053.002.N



Z051.004.R

HW OGEE BITS WITH BALL BEARING GUIDE Z=2

ART. E326 - G326

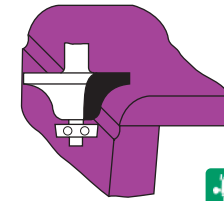
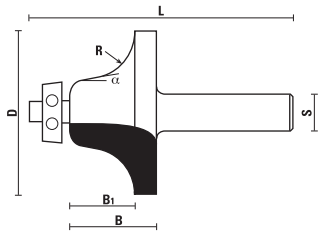

15° ball bearing with Delrin® ring

S Ø 12	S Ø 1/2" (12,7)	D	B	B1	L	R	α
E326.550.R	G326.550.R	55	25	19	75	12,7	15°
E326.610.R	G326.610.R	61	32	25	86	14	15°



Z050.102.N



Z053.002.N



Z051.004.R

HW COUNTER-TOP BITS WITH BALL BEARING GUIDE Z=2

ART. E330 - G330

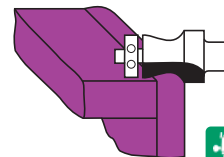
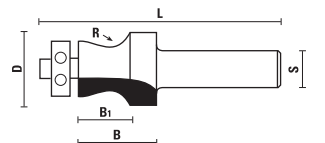

For anti-drip profile on washbasin

S Ø 12	S Ø 1/2" (12,7)	D	B	B1	L	R
E330.220.R	G330.220.R	25	22	16	79	8
E330.290.R	G330.290.R	25	29	24	85	8



Z050.101.N



Z053.002.N



Z051.004.R



SAWBLADES FOR CUTTING SOLID SURFACE AT SECTION 12

HW CORNER ROUNDING BITS WITH BALL BEARING GUIDE Z=2

ART. E334 - G334

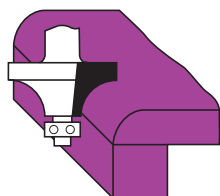
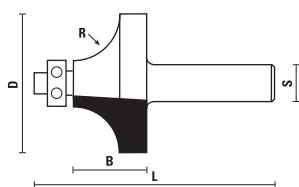

S Ø 12	S Ø 1/2" (12,7)	D	B	L	R
E334.254.R	G334.254.R	25,4	13	62	6,4
E334.286.R	G334.286.R	28,6	13,5	61	8
E334.380.R	G334.380.R	38	19	65	12,7
E334.510.R	G334.510.R	51	25	72	19



HW ROUNDING-UNDER BITS WITH UPPER BALL BEARING GUIDE Z=2

ART. E335 - G335

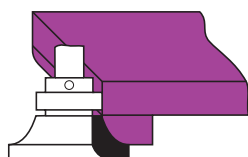
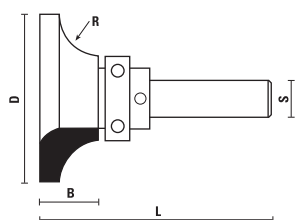

For bottom rounding

S Ø 12	S Ø 1/2" (12,7)	D	B	L	R
E335.540.R	G335.540.R	54	20	73	12,7
E335.670.R*	G335.670.R	67	25	77	19

*Selling out



HW CORNER-ROUNDING BITS WITH BALL BEARING GUIDE Z=2

ART. E336 - G336

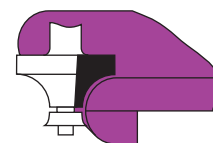
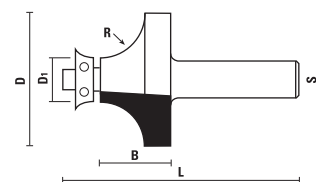
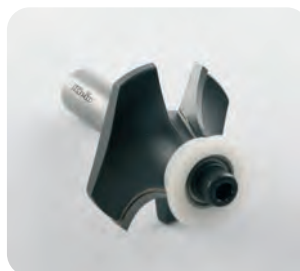

R=12,7 ball bearing

S Ø 12	S Ø 1/2" (12,7)	D	D1	R	B	L
E336.410.R	G336.410.R	41	16	13	19	68



S Ø 12	S Ø 1/2" (12,7)	D	D1	R	B	L
E336.540.R	G336.540.R	54	16	19	25	74



HW UPSTAND BITS Z=2

ART. E340 - G340

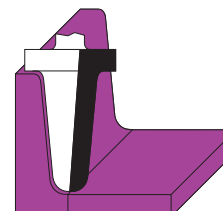
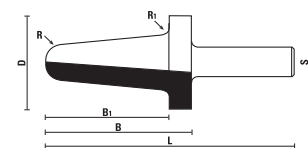

S Ø 12	S Ø 1/2" (12,7)	D	B	B1	R	R1	L
E340.390.R*		39	40	30	6	3	78
E340.391.R	G340.391.R	39	55	45	6	3	93

*Selling out

HW COVE BITS WITH UPPER BALL BEARING GUIDE Z=2

ART. E342 - G342

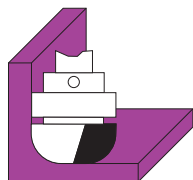
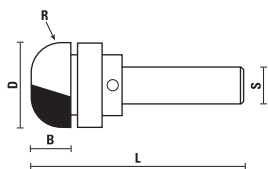

S \varnothing 12	S \varnothing 1/2" (12,7)	D	B	R	L
E342.286.R	G342.286.R	28,6	13	10	73

Z050.104.N	Z058.003.N	Z051.005.R

HW BOWL AND COUNTERTOP TRIM BITS Z=6

ART. E350 - G350

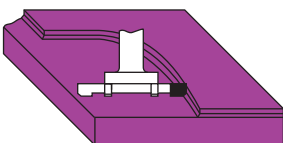
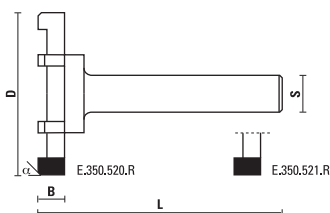

S \varnothing 12	S \varnothing 1/2" (12,7)	D	B	L	Z	α
E350.520.R	G350.520.R	52	6,5	83	6	0,5x45°
E350.521.R	G350.521.R	52	6,5	83	6	0°

HW PROFILE BITS Z=2

ART. E360

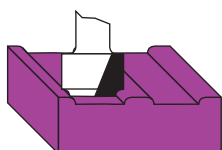
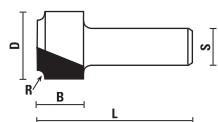

S \varnothing 12	D	B	R	L
E360.246.R	24,6	16	2	60

HW PROFILE BITS Z=2

ART. E361

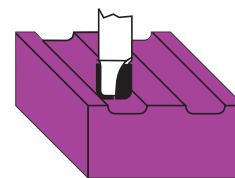
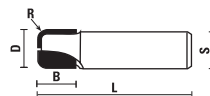

S \varnothing 12	D	B	R	L
E361.127.R	12,7	13	3,2	51
E361.160.R	16	13	3,2	51
E361.190.R	19	13	3,2	51

HW UNDERMOUNT PROFILE BOWL BITS WITH BALL BEARING GUIDE Z=2

ART. E362

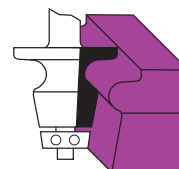
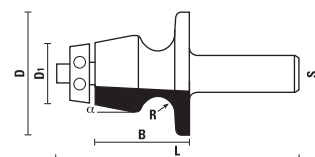

10° ball bearing with Delrin® ring

S \varnothing 12	D	D1	B	R	L	α
E362.420.R	42	22	33	6,4	84	10°

Z050.102.N	Z053.002.N	Z051.004.R

HW BEVEL HOB BITS WITH BALL BEARING GUIDE Z=2

ART. E363

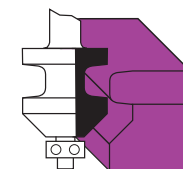
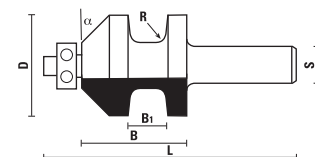

S \varnothing 12	D	B	B1	R	L	α
E363.350.R	35	36,5	12-13	3,2	89	45°

Z050.011.N	Z054.003.N	Z051.004.R

HW BEADING BITS Z=2

ART. E364

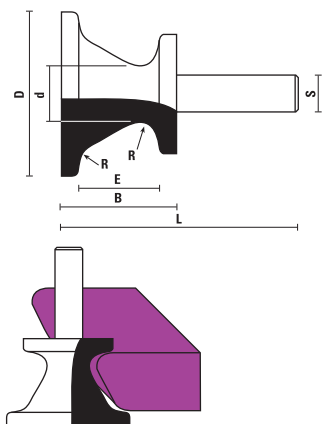

S \varnothing 12	D	d	B	E	R	L
E364.370.R Selling out	37	16	25	12-13	4,8	84
E364.540.R Selling out	54	19	37	24-26	6,4	96
E364.710.R Selling out	71	22	50	36-39	9,5	109

HW TRIPLE BEADING BITS WITH BALL BEARING GUIDE Z=2

ART. E365

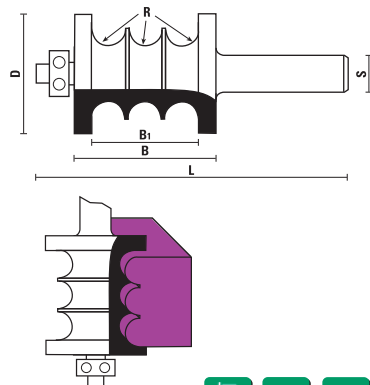

S \varnothing 12	D	B	B ₁	R	L
E365.410.R Selling out	41	51	39	6	101

Z050.011.N
 Z053.002.N
 Z051.004.R

HW DOUBLE BEADING BITS WITH BALL BEARING GUIDE Z=2

ART. E366

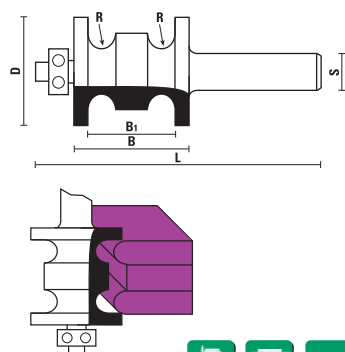

S \varnothing 12	D	B	B ₁	R	L
E366.380.R Selling out	38	51	38	6	79

Z050.011.N
 Z054.003.N
 Z051.004.R

HW MULTI BEADING BITS WITH BALL BEARING GUIDE Z=2

ART. E367

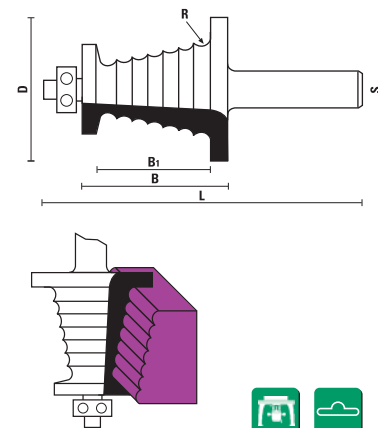

S \varnothing 12	D	B	B ₁	R	L
E367.510.R Selling out	51	51	38	3	99

Z050.011.N
 Z053.002.N
 Z051.002.R

HW EDGE Moulding BITS WITH BALL BEARING GUIDE Z=2

ART. E370

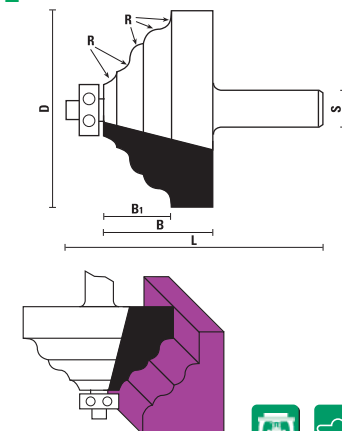

S \varnothing 12	D	B	B ₁	R	L
E370.700.R Selling out	70	40	33	4,8	87

Z050.101.N
 Z053.002.N
 Z051.004.R

HW WAVY EDGE BITS WITH BALL BEARING GUIDE Z=2

ART. E371

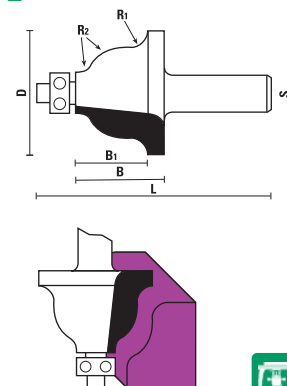

S \varnothing 12	D	B	B ₁	R ₁	R ₂	L
E371.440.R Selling out	44	32	25	6	13	82,5

Z050.100.N
 Z053.002.N
 Z051.002.R

HW EDGE MOULDING BITS WITH BALL BEARING GUIDE Z=2

ART. E373

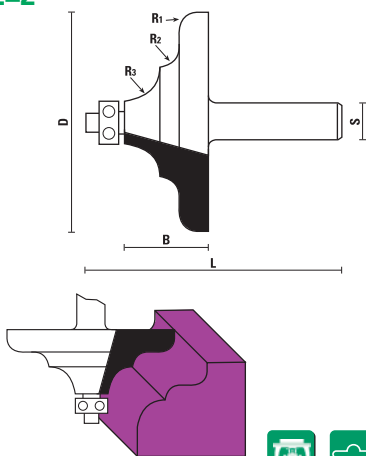

S Ø 12	D	R1	R2	R3	B	L
E373.760.R Selling out	76	6,4	6	12,7	30	78



HW ROMAN OGEE BITS WITH BALL BEARING GUIDE Z=2

ART. E375

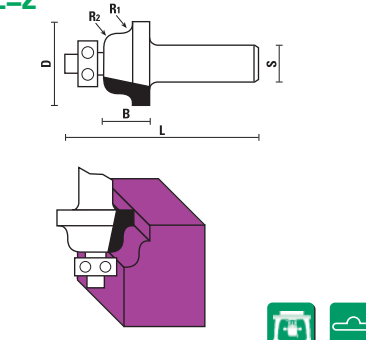

S Ø 12	D	B	R1	R2	L
E375.286.R	28,6	16	3,2	4	63,5



HW EDGE MOULDING BITS WITH BALL BEARING GUIDE Z=2

ART. E376

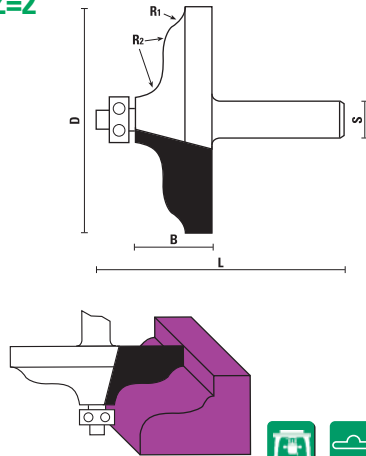

S Ø 12	D	B	R1	R2	L
E376.790.R Selling out	79	28	5,2	9	74,5



HW EDGE MOULDING BITS WITH BALL BEARING GUIDE Z=2

ART. E377

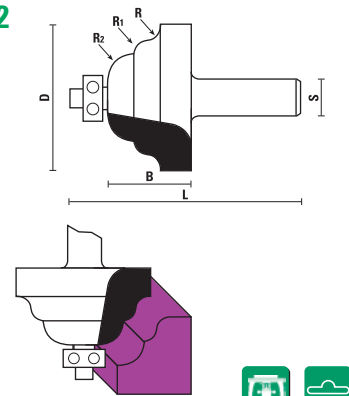

S Ø 12	D	R	R1	R2	B	L
E377.510.R Selling out	51	4,4	4,4	9,5	28	82,5



HW EDGE MOULDING BITS WITH BALL BEARING GUIDE Z=2

ART. E378

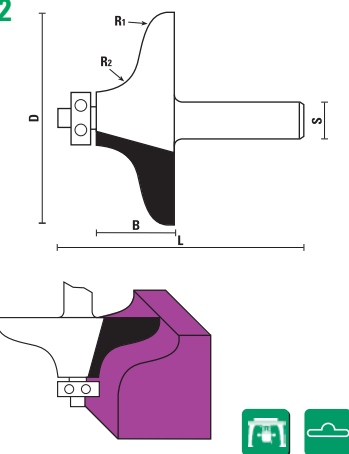

S Ø 12	D	B	R1	R2	L
E378.760.R Selling out	76	28	8	12,7	79



HW BEVEL BITS WITH BALL BEARING GUIDE Z=2

ART. E380 - G380

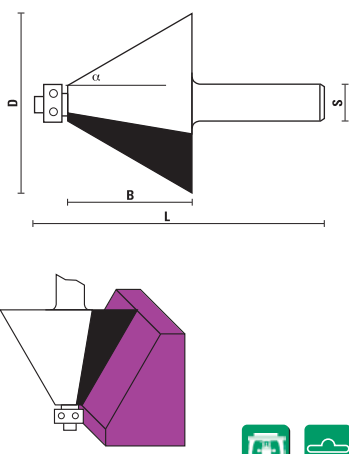
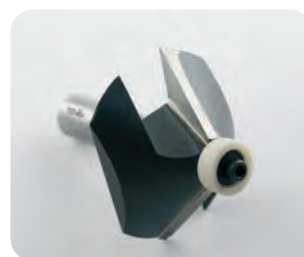

S Ø 12	S Ø 1/2" (12,7)	D	B	L	α
E380.510.R	G380.510.R	51	19	67	45°
E380.640.R	G380.640.R	64	44	93	30°



HW EDGE Moulding BITS WITH BALL BEARING GUIDE Z=2

ART. E381

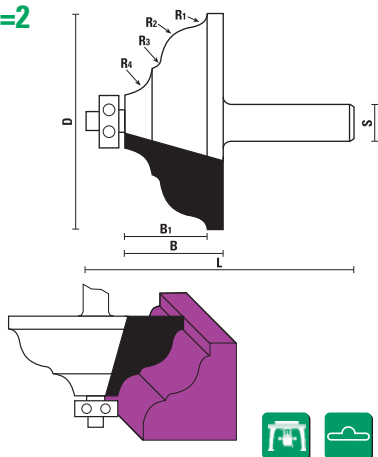

S Ø 12	D	B	B1	R1	R2	R3	R4	L
E381.760.R Selling out	76	34,9	29	4,8	12,7	3,2	9,5	84



Z050.101.N



Z053.002.N



Z051.004.R

HW ROUTER BITS FOR SINK REPAIRING

ART. E382 - G382

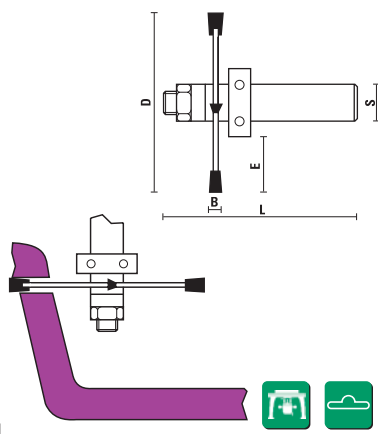

Z050.112.N

S Ø 12	S Ø 1/2" (12,7)	D	E	B	L	Z
E382.670.R	G382.670.R	80	25,7	6	96	4

SPARE PARTS

Spare arbor

E117.120.N

Spare cutter

D= Ø 80/Ø 8 Z=4

C118.980.R

HW ROUNDING OVER UNDERMOUNT BOWL BITS WITH BALL BEARING GUIDE Z=2

ART. E383 - G383

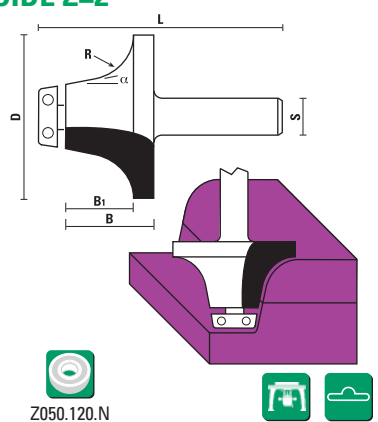

Z050.120.N

17° ball bearing with Delrin® ring

S Ø 12	S Ø 1/2" (12,7)	D	B	B1	R	L	α
E383.450.R	G383.450.R	45	17,5	13,5	9,5	63,5	17°
E383.510.R	G383.510.R	51	17,5	13,5	12,7	63,5	17°
E383.540.R	G383.540.R	54	25	20	12,7	73	17°
E383.570.R	G383.570.R	57	25	20	19	76	17°

HW ROUNDING OVER UNDERMOUNT BOWL BITS WITH BALL BEARING GUIDE Z=2

ART. E384

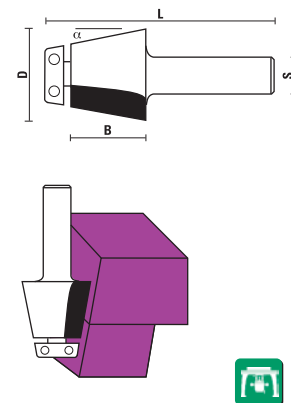

12° ball bearing with Delrin® ring

S Ø 12	D	B	L	α
E384.320.R	32	25	76	12°



Z050.102.N

INSERT FLUSH TRIM BITS Z=2

ART. W138

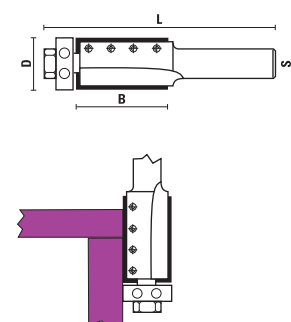

- HW knives with "Kawedur" coating
- For CORIAN®
- Ball bearing with Delrin® ring

S Ø 12	D	B	L
W138.190.R	19	30	82



Z050.111.N



Z055.230.N



Z051.101.N

INSERT FLUSH TRIM BITS Z=2

ART. W138

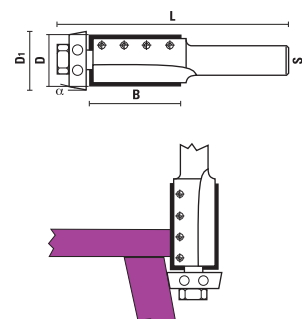

- HW knives with "Kawedur" coating
- For CORIAN®
- 11° ball bearing with Delrin® ring

S Ø 12	D	D1	B	L	α
W138.220.R	19	22	30	82	11°



Z050.110.N



Z055.230.N



Z051.101.N

See also section 9 page 9.07 for more details

HW/HS STRAIGHT PLUNGE CUTTING BITS FOR "ELU" Z=2

ART. F101

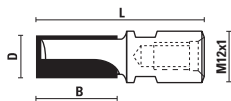

S = M12x1	D	B	L	Mat.
F101.060.R	6	18	60	HW
F101.070.R	7	20	60	HW
F101.080.R	8	25	60	HW
F101.100.R	10	25	60	HW
F101.120.R	12	25	60	HW
F101.140.R	14	25	60	HW
F101.150.R	15	25	60	HW
F101.160.R	16	25	60	HW
F101.180.R	18	25	60	HW
F101.200.R	20	25	60	HW
F101.220.R	22	25	60	HW
F101.240.R	24	25	60	HW
F101.250.R	25	25	60	HW
F101.300.R	30	25	60	HW

HW STRAIGHT PLUNGE CUTTING BITS FOR "ELU" Z=2

ART. F103 - F104 - F105

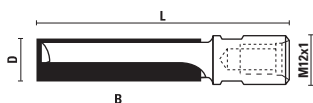

Long execution

S = M12x1	D	B	L
F103.080.R	8	35	67
F103.100.R	10	35	67
F103.120.R	12	35	67
F103.140.R	14	35	67
F103.160.R	16	35	67
F103.180.R	18	35	67
F103.200.R	20	35	67
F103.220.R	22	35	67
F104.120.R	12	45	77
F104.150.R	15	45	77
F104.160.R	16	45	77
F104.161.R	16	50	82
F104.180.R	18	45	77
F104.200.R	20	45	77
F105.140.R	14	60	92
F105.160.R	16	60	92
F105.180.R	18	60	92
F105.200.R	20	60	92
F105.220.R	22	60	92

HW STRAIGHT PLUNGE CUTTING BITS FOR "SCHEER" Z=2

ART. F152 - F153

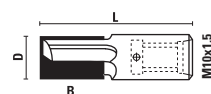

S = M10x1,5	D	B	L
F152.040.R	4	10	55
F152.050.R	5	12	55
F152.060.R	6	14	55
F152.080.R	8	20	55
F152.100.R	10	22	55
F152.120.R	12	22	55
F152.140.R	14	25	55
F152.150.R	15	25	55
F152.160.R	16	25	55
F152.180.R	18	25	55
F152.200.R	20	25	55
F152.220.R	22	25	55
F152.240.R	24	25	55
F152.250.R	25	25	55
F152.300.R	30	25	55

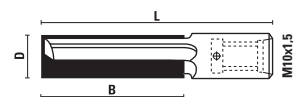

Long execution

S = M10x1,5	D	B	L
F153.060.R	6	30	65
F153.080.R	8	35	70
F153.100.R	10	35	70
F153.120.R	12	35	70
F153.140.R	14	35	70
F153.160.R	16	45	75
F153.180.R	18	45	75
F153.200.R	20	45	75
F153.220.R	22	45	75

HW DRILL BITS FOR "FESTOOL" MACHINES Z=2

ART. F160

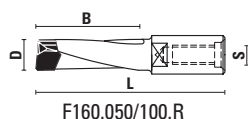
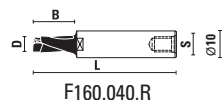

- To be used on Festool® joining machines "Domino DF500"
 - Suitable for creating dowel cross-cut for making "Domino®" joints for frames, drawers, cabinets and furniture



S = M6x0,75	D	B	L
F160.040.R Solid carbide	4	11	38
F160.050.R	5	20	49
F160.060.R	6	28	49
F160.080.R	8	28	49
F160.100.R	10	28	49

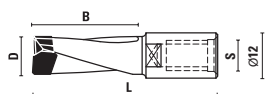

To be used on Festool® joining machines "Domino XL DF700"
 Suitable for creating dowel cross-cut for making "Domino®" joints for kitchen cabinets, tables and door frames



S = M8x1	D	B	L
F161.080.R	8	50	90
F161.100.R	10	70	90
F161.120.R	12	70	90
F161.140.R	14	70	90



HW FLUSH TRIMMING BITS WITH BALL BEARING GUIDE Z=2

ART. F108

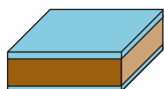
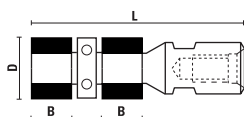

S = M12x1	D	B	L
F108.190.R	19	20	90



HW RADIUS BITS Z=2

ART. F110

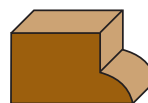
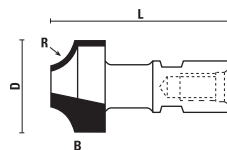

S = M12x1	D	R	B	L
F110.320.R selling out	32	10	15	60
F110.370.R selling out	37	12	18	60

HW RADIUS BITS WITH BALL BEARING GUIDE Z=2

ART. F111

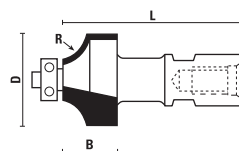

S = M12x1	D	R	B	L
F111.290.R	29	8	13	60
F111.330.R	33	10	15	60
F111.370.R	37	12	17	60
F111.430.R	43	15	20	60
F111.530.R	53	20	25	60

HW RADIUS BITS Z=2

ART. F112

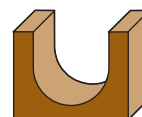
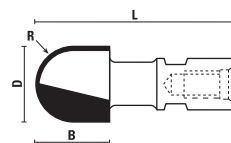

S = M12x1	D	R	B	L
F112.160.R	16	8	18	60
F112.200.R	20	10	18	60
F112.240.R	24	12	18	60
F112.300.R	30	15	18	60

HW RADIUS BITS Z=2

ART. F114

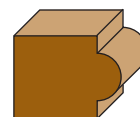
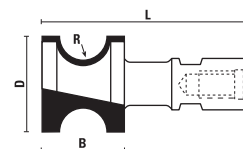

S = M12x1	D	R	B	L
F114.450.R	45	15	50	80

ROUTER BITS FOR HAND PORTABLE ROUTER MACHINES "ECONOMY LINE"



HW STRAIGHT BITS Z=2
Page 4.03



HW DOVETAIL BITS Z=2
Page 4.03

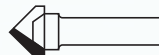

HW "V"-GROOVING BITS Z=2
Page 4.03

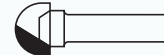

HW CORE BOX BITS Z=2
Page 4.03

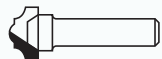

HW CLASSICAL BITS Z=2
Page 4.03



HW FLUSH TRIMMING BITS WITH
BALL BEARING Z=2
Page 4.03

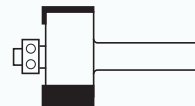

HW RABBETTING BITS WITH
BALL BEARING Z=2
Page 4.03

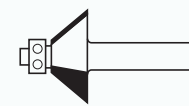

HW BEVEL TRIMMING BITS WITH
BALL BEARING Z=2
Page 4.04

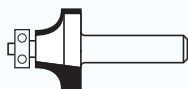

HW ROUNDING OVER BITS WITH
BALL BEARING Z=2
Page 4.04

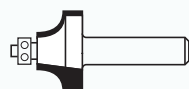

HW BEADING BITS WITH
BALL BEARING Z=2
Page 4.04



HW COVE BITS WITH BALL BEARING Z=2
Page 4.04



HW OGEE BITS WITH
BALL BEARING Z=2
Page 4.04

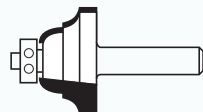

HW CLASSICAL BITS WITH
BALL BEARING Z=2
Page 4.04



VHW FLUSH TRIMMER - Z=1
Page 4.05



VHW BEVEL TRIMMER - Z=1
Page 4.05



VHW COMBINATION FLUSH & BEVEL
TRIMMER - Z=1
Page 4.05



6 PIECE CLASSICAL HOBBY
ROUTER BITS "STARTER SET"
Page 4.06



12 PIECE CLASSICAL HOBBY
ROUTER BITS "ADVANCED SET"
Page 4.06



HW STRAIGHT BITS Z=2

ART. HA101 - HB101 - HC101

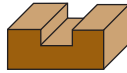
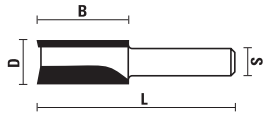

S Ø 6	S Ø 1/4" (6,35)	S Ø 8	D	B	L
HA101.050.R	HB101.050.R	HC101.050.R	5	12	48
HA101.060.R	HB101.060.R	HC101.060.R	6	20	48
HA101.080.R	HB101.080.R	HC101.080.R	8	20	48
HA101.100.R	HB101.100.R	HC101.100.R	10	20	48
HA101.120.R	HB101.120.R	HC101.120.R	12	20	48
HA101.127.R	HB101.127.R	HC101.127.R	12,7	20	48
HA101.140.R	HB101.140.R	HC101.140.R	14	20	48
HA101.160.R	HB101.160.R	HC101.160.R	16	20	48
HA101.180.R	HB101.180.R	HC101.180.R	18	20	48
HA101.190.R	HB101.190.R	HC101.190.R	19	20	48
HA101.200.R	HB101.200.R	HC101.200.R	20	20	48

HW DOVETAIL BITS Z=2

ART. HA108 - HB108 - HC108

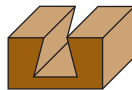
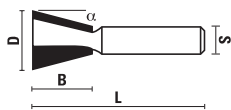

S Ø 6	S Ø 1/4" (6,35)	S Ø 8	D	B	α	L
HA108.127.R	HB108.127.R	HC108.127.R	12,7	13	14°	45

HW "V"-GROOVING BITS Z=2

ART. HA109 - HB109 - HC109
HA110 - HB110 - HC110

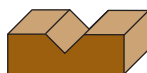
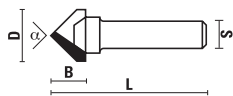

S Ø 6	S Ø 1/4" (6,35)	S Ø 8	D	B	α	L
HA109.127.R	HB109.127.R	HC109.127.R	12,7	8	90°	40
HA110.095.R	HB110.095.R	HC110.095.R	9,5	10	60°	42

HW CORE BOX BITS Z=2

ART. HA111 - HB111 - HC111

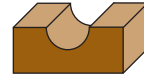
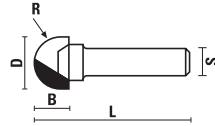

S Ø 6	S Ø 1/4" (6,35)	S Ø 8	D	B	R	L
HA111.064.R	HB111.064.R	HC111.064.R	6,4	5	3,2	47
HA111.127.R	HB111.127.R	HC111.127.R	12,7	8	6,4	47

HW CLASSICAL BITS Z=2

ART. HA115 - HB115 - HC115

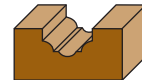
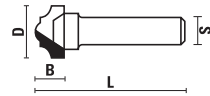

S Ø 6	S Ø 1/4" (6,35)	S Ø 8	D	B	L
HA115.127.R	HB115.127.R	HC115.127.R	12,7	8	40

HW FLUSH TRIMMING BITS WITH BALL BEARING Z=2

ART. HA119 - HB119 - HC119

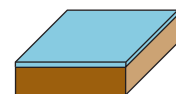
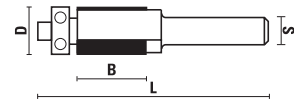

Ideal for working laminated panels

S Ø 6	S Ø 1/4" (6,35)	S Ø 8	D	B	L
HA119.127.R	HB119.127.R	HC119.127.R	12,7	13	54

HW RABBETING BITS WITH BALL BEARING Z=2

ART. HA121 - HB121 - HC121

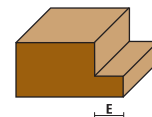
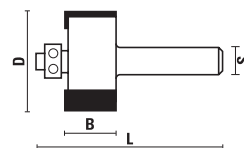

S Ø 6	S Ø 1/4" (6,35)	S Ø 8	D	B	E	L
HA121.286.R	HB121.286.R	HC121.286.R	28,6	13	9,5	47

HW BEVEL TRIMMING BITS WITH BALL BEARING Z=2

ART. HA122 - HB122 - HC122

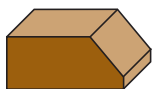
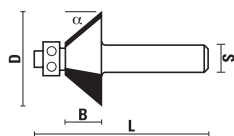

S Ø 6	S Ø 1/4" (6,35)	S Ø 8	D	B	α	L
HA122.160.R	HB122.160.R	HC122.160.R	16	6,5	25°	47
HA122.320.R	HB122.320.R	HC122.320.R	32	12,5	45°	47

HW ROUNDING OVER BITS WITH BALL BEARING Z=2

ART. HA123 - HB123 - HC123

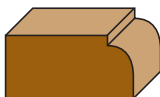
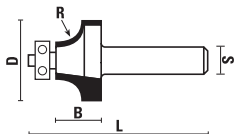

S Ø 6	S Ø 1/4" (6,35)	S Ø 8	D	B	R	L
HA123.158.R	HB123.158.R	HC123.158.R	15,8	10	3,2	44
HA123.220.R	HB123.220.R	HC123.220.R	22	13	6,3	46
HA123.250.R	HB123.250.R	HC123.250.R	25	15	8	49
HA123.286.R	HB123.286.R	HC123.286.R	28,6	17	9,5	50

HW BEADING BITS WITH BALL BEARING Z=2

ART. HA124 - HB124 - HC124

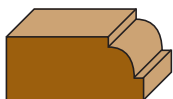
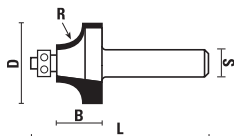

S Ø 6	S Ø 1/4" (6,35)	S Ø 8	D	B	R	L
HA124.158.R	HB124.158.R	HC124.158.R	15,8	10	3,2	44
HA124.220.R	HB124.220.R	HC124.220.R	22	13	6,3	46
HA124.250.R	HB124.250.R	HC124.250.R	25	15	8	49
HA124.286.R	HB124.286.R	HC124.286.R	28,6	17	9,5	50

HW COVE BITS WITH BALL BEARING Z=2

ART. HA125 - HB125 - HC125

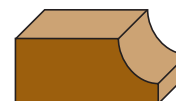
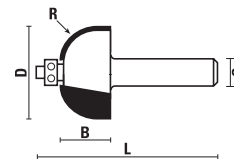

S Ø 6	S Ø 1/4" (6,35)	S Ø 8	D	B	R	L
HA125.220.R	HB125.220.R	HC125.220.R	22	13	6,3	47
HA125.286.R	HB125.286.R	HC125.286.R	28,6	14	9,5	48

HW OGEE BITS WITH BALL BEARING Z=2

ART. HA127 - HB127 - HC127

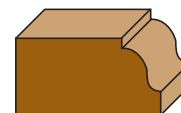
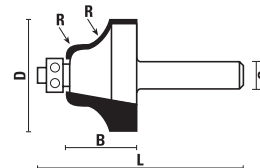

S Ø 6	S Ø 1/4" (6,35)	S Ø 8	D	B	R	L
HA127.250.R	HB127.250.R	HC127.250.R	25	16	4	50

HW CLASSICAL BITS WITH BALL BEARING Z=2

HA128 - HB128 - HC128

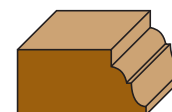
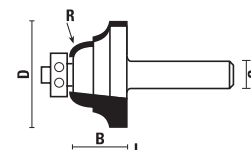

S Ø 6	S Ø 1/4" (6,35)	S Ø 8	D	B	R	L
HA128.250.R	HB128.250.R	HC128.250.R	25	16	4	50

VHW FLUSH TRIMMER - Z=1

ART. HB190

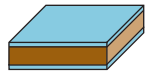

- Solid carbide
- Ideal for working laminated panels



S \varnothing 1/4" (6,35)	D	B	L
HB190.065.R - Top grind	6,35	6,5	38
HB190.096.R - Top grind	6,35	9,6	38

VHW COMBINATION FLUSH & BEVEL TRIMMER - Z=1

ART. HB192

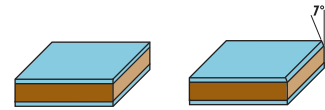
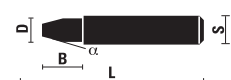

- Solid carbide
- Ideal for working laminated panels



S \varnothing 1/4" (6,35)	D	B	α	L
HB192.064.R	6,4	9,5	7°	38

VHW BEVEL TRIMMER - Z=1

ART. HB191

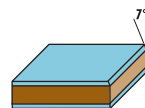
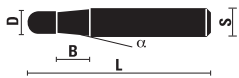

- Solid carbide
- Ideal for working laminated panels



S \varnothing 1/4" (6,35)	D	B	α	L
HB191.065.R - Top grind	5	6,5	7°	38

6 PIECE CLASSICAL HOBBY ROUTER BITS "STARTER SET"

ART. HX002



- Set including the 6 most popular hobby T.C.T. router bits in a robust and practical wooden box
- Ideal to have always on hand the right bit for straight cut, engraving and profiling

HX002.006.R (S Ø 6)	HX002.008.R (S Ø 8)
6-pcs router bit set:	6-pcs router bit set:
HA101.060.R	HC101.060.R
HA101.120.R	HC101.120.R
HA109.127.R	HC109.127.R
HA123.286.R	HC123.286.R
HA124.220.R	HC124.220.R
HA127.250.R	HC127.250.R

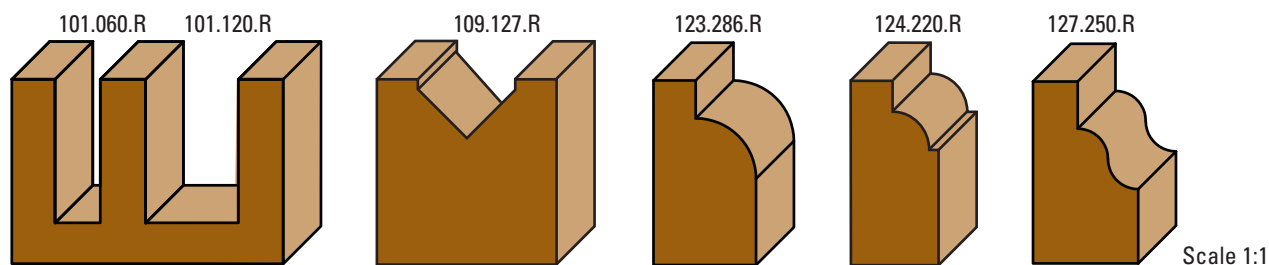

12 PIECE CLASSICAL HOBBY ROUTER BITS "ADVANCED SET"

ART. HX005



- Set including the 12 most popular hobby T.C.T. router bits in a robust and practical wooden box
- Ideal to have always on hand the right bit for straight cut, trimming, engraving, profiling and dovetail joints

HX005.006.R (S Ø 6)	HX005.008.R (S Ø 8)		
12-pcs router bit set:	12-pcs router bit set:		
HA101.060.R	HA119.127.R	HC101.060.R	HC119.127.R
HA101.120.R	HA122.320.R	HC101.120.R	HC122.320.R
HA101.160.R	HA123.220.R	HC101.160.R	HC123.220.R
HA108.127.R	HA123.286.R	HC108.127.R	HC123.286.R
HA109.127.R	HA125.220.R	HC109.127.R	HC125.220.R
HA111.127.R	HA127.250.R	HC111.127.R	HC127.250.R

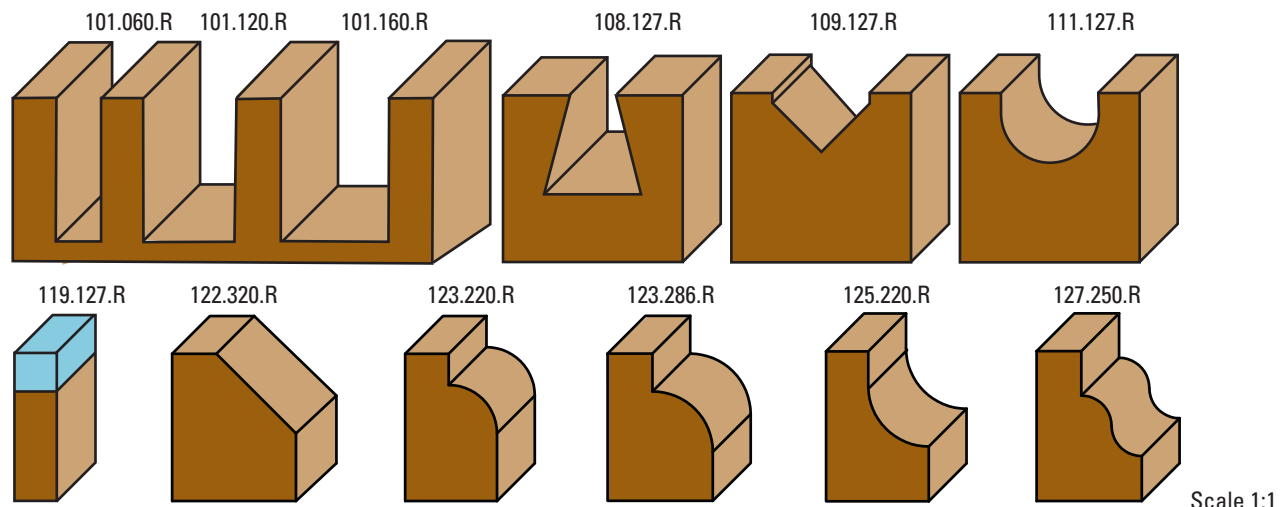

DOWEL DRILLS AND BORING BITS FOR AUTOMATIC BORING MACHINES

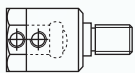

DRILL ADAPTORS
Page 5.04

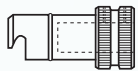

QUICK CHANGE DRILL HOLDERS
Page 5.05, 5.06

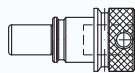

**CHUCKS FOR MACHINES "BIESSE"
WITH AUTOMATIC CHANGE**
Page 5.06

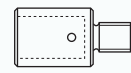

QUICK CHANGE CHUCKS
Page 5.06 - 5.07



HW DOWEL DRILLS Z=2
Page 5.07



HW THROUGH HOLE DRILL BITS Z=2
Page 5.07



HW DOWEL DRILLS Z=2
Page 5.08



HW DOWEL DRILLS Z=2
Page 5.08



HW DOWEL DRILLS Z=2
Page 5.09



HW DOWEL DRILLS EXTRA FINE Z=2
Page 5.10



HW DOWEL DRILLS EXTRA TIME Z=2
Page 5.11



VHW DOWEL DRILLS EXTRA TIME Z=2
Page 5.11



VHW DOWEL DRILLS Z=2, KleinDIA COATED
Page 5.11



VHW DOWEL DRILLS Z=2
Page 5.12



VHW DOWEL DRILLS Z=2
Page 5.12



DP DOWEL DRILLS
Page 5.12



VHW TWIST DRILLS Z=2
Page 5.13

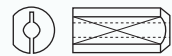

DRILL HOLDER-SLEEVES
Page 5.13

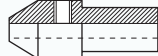

DRILL HOLDERS
Page 5.13



HW THROUGH HOLE DRILL BITS Z=2
Page 5.14



HW THROUGH HOLE DRILL BITS Z=2
Page 5.14



VHW THROUGH HOLE DRILL BITS Z=2
Page 5.15



VHW THROUGH HOLE DRILL BITS Z=2
KleinDIA COATED
Page 5.15



DP THROUGH-HOLE DRILL BITS
Page 5.15



HW COUNTERSINKS Z=2 - 90°
Page 5.16



VHW DOWEL DRILLS FOR
BOTH RIGHT HAND AND LEFT
HAND ROTATION Z=1
Page 5.16



HW DOWEL DRILLS WITH
COUNTERSINK Z=2
Page 5.16



HW THROUGH HOLE DRILL BITS "E.T."
LINE Z=2
Page 5.17



VHW THROUGH HOLE DRILL BITS
"E.T." LINE Z=2
Page 5.17



VHW THROUGH HOLE DRILL BITS Z=2 "E.T."
LINE, KleinDIA COATED
Page 5.17

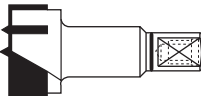

HW HINGE BORING BITS Z=2+2
Page 5.18

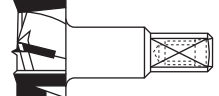

HW HINGE BORING BITS Z=3+3
Page 5.19

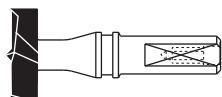

VHW HINGE BORING BITS Z=2+2
Page 5.19

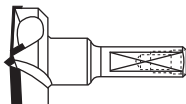

DP HINGE BORING BITS
Page 5.19

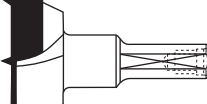

HW HINGE BORING BITS Z=2+2
Page 5.20

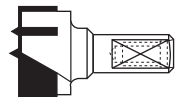

HW HINGE BORING BITS Z=2+2
Page 5.20



HW DOWEL DRILLS Z=2
Page 5.20



HW DRILLS FOR CABINEO® Z=2
Page 5.20



HW DOWEL DRILLS FOR CABINEO® Z=2
Page 5.20



HW DOWEL DRILLS WITH THREADED
SHANK Z=2
Page 5.21



HW DOWEL DRILLS WITH COUNTERSINK
THREADED SHANK Z=2
Page 5.21



HW DOWEL DRILLS WITH THREADED
SHANK Z=2
Page 5.21



HW DOWEL DRILLS WITH COUNTERSINK
THREADED SHANK Z=2
Page 5.21

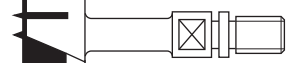

HW HINGE BORING BITS WITH
THREADED SHANK Z=2
Page 5.22

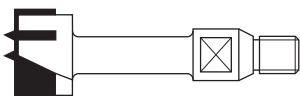

HW HINGE BORING BITS WITH
THREADED SHANK Z=2+2
Page 5.22

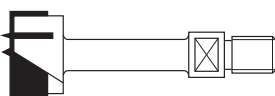

HW HINGE BORING BITS WITH THREADED
SHANK Z=2+2
Page 5.22

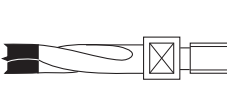

HW DOWEL DRILLS WITH THREADED
SHANK Z=2
Page 5.22

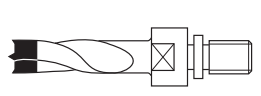

HW DOWEL DRILLS WITH THREADED
SHANK Z=2
Page 5.22

DRILLING

The experience of **SISTEMI** is being always available to its customers in choosing the right tool for the desired processing. In this regard, a wide range of factors must be taken into consideration. Here is a summary list:

- 1) In addition to the traditional drilling bits with brazed carbide tips sometimes it is important to evaluate the use of **solid carbide drills** (Art. L116/L117/L118/L129/L134/L135) **that can ensure performance benefits**, longer life, higher number of resharpening times and higher resistance to breakage of tool body;
- 2) Choosing the drill bit according to the working material by properly setting RPM and feed speed as indicated in the following tables help to optimize the process;
- 3) To reduce the time of assembly and align the drills, **we recommend using our quick change drill chucks** (Art. L030 ÷ L060);
- 4) **Regular cleaning and maintenance** of the drills and adaptors **improve the performance and life of tools**, reducing the risk of breakage and increasing the quality of the worked pieces;
- 5) To improve the chips flow, the boring bits are coated with a **PTFE-based heat treatment** (Polytetrafluoroethylene) in black for Right Rotation and orange for Left Rotation.



THE NEW COATED BITS FOR LARGE SCALE INDUSTRY



- DLC DIAMOND ANTIFRICTION COATING
- LONGER TOOL LIFE
- EXCELLENT PERFORMANCE ON EVERY KIND OF MATERIAL
- GREATER PRODUCTIVITY

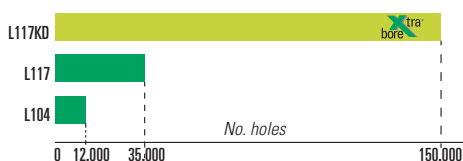

How to choose the right Boring Bits

Types of material Items	Softwood (Cider, Poplar, Pine, etc.)	Hardwood (Ash, Walnut, Beech, Oak, Teak, etc.)	Pressed Wood (Plywood, Blockboard)	Chipboard	Laminated Wood (Veneered, melamine coated panels, HPL, etc.)	MDF	Trespa®
L101/L102/L103/L104 - Pag. 5.07, 5.08	XX	XX	XX	XX	X	XX	
L105/L106/L107/L108 - Pag. 5.08	XX	XX	XX	XX	X	XX	
L109/L110 - Pag. 5.09	XX	XX	XX	XX	X	XX	
L112/L113/L114/L115 - Pag. 5.10	XX	XX	XXX	XXX	XXX	XXX	
L116/L117 - Pag. 5.11	XX	XX	XXX	XXX	XXX	XXX	XX
L118 - Pag. 5.12	X	X	X	X	X	XX	XXX
L132/L133 - Pag. 5.17	XXX	XXX	XXX	XXX	XXX	XXX	XX
L134/L135 - Pag. 5.17	XXX	XXX	XXX	XXX	XXX	XXX	XX
L120 - Pag. 5.13	XX	XX	XX	XX	XX	XX	XX
L121/L122/L123/L124 - Pag. 5.07, 5.14	XX	XX	XX	XX	X	XX	
L125/L126/L127 - Pag. 5.14	XX	XX	XX	XX	X	XX	
L129 - Pag. 5.15	XXX	XXX	XXX	XXX	XX	XXX	XX
L140/L141/L142 - Pag. 5.18	XX	XX	XXX	XXX	XX	XX	
L143/L144/L150/L151 - Pag. 5.18, 5.19	XX	XX	XXX	XXX	X	XX	
L155 - Pag. 5.19	XXX	XXX	XXX	XXX	XXX	XXX	XX
L160/L170 - Pag. 5.20	XX	XX	XXX	XXX	XX	XX	

X = Satisfactory - XX = Good - XXX = Excellent

Technical data and images are just an indication. **SISTEMI** srl reserves the right to modify the above information at any time and without notice.

DRILL ADAPTORS

ART. L001 - M10/11x4

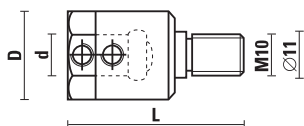

For: MORBIDELLI, BIESSE, WEEKE

RH rotation	LH rotation	d	D	L
L001.080.R	L001.080.L	8	15,5	41
L001.100.R	L001.100.L	10	19,5	41



Z051.301.R

DRILL ADAPTORS

ART. L004 - M8/9x3

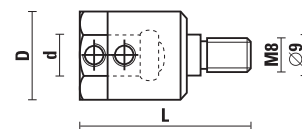

For: MORBIDELLI, NOTTMEYER

RH rotation	LH rotation	d	D	L
L004.080.R	L004.080.L	8	15,5	41
L004.100.R	L004.100.L	10	19,5	41
L004.101.R	L004.101.L	10	15	41



Z051.301.R

DRILL ADAPTORS

ART. L002 - M10/Taper 30°

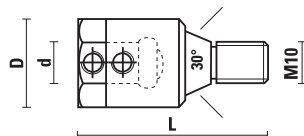

For: VITAP, BUSELLATO, SCHLEICHER

RH rotation	LH rotation	d	D	L
L002.080.R	L002.080.L	8	15,5	46
L002.100.R	L002.100.L	10	19,5	46



Z051.301.R

DRILL ADAPTORS

ART. L005 - M8

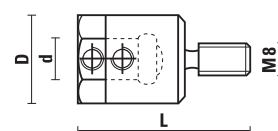

For: NOTTMEYER

RH rotation	LH rotation	d	D	L
L005.080.R	L005.080.L	8	15,5	40
L005.100.R	L005.100.L	10	19,5	40



Z051.301.R

DRILL ADAPTORS

ART. L003 - M10

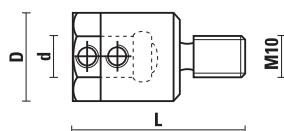

For: AYEN, HOLZMA, MAYER

RH rotation	LH rotation	d	D	L
L003.080.R	L003.080.L	8	15,5	40
L003.100.R	L003.100.L	10	19,5	40



Z051.301.R

DRILL ADAPTORS

ART. L006 - M8 - 20°48'

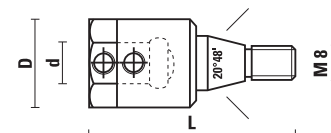

For: BILEK

RH rotation	LH rotation	d	D	L
L006.080.R	L006.080.L	8	15,5	51
L006.100.R	L006.100.L	10	19,5	51



Z051.301.R

QUICK CHANGE DRILL HOLDERS

ART. L030

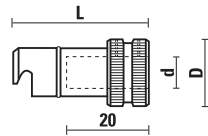

For: **BIESSE**

RH rotation	LH rotation	d	D	L
L030.100.R	L030.100.L	10	20	37
L030.101.R	L030.101.L lowered	10	20	30
L030.102.R	L030.102.L threaded	M10	20	37



Z051.314.R

QUICK CHANGE DRILL HOLDERS

ART. L031

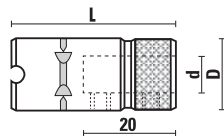

For: **MORBIDELLI**

RH rotation	LH rotation	d	D	L
L031.100.R		10	20	43
L031.101.R lowered		10	16	43
L031.102.R	L031.102.L threaded	M10	20	43



Z051.314.R
(L031.100.R)



Z051.313.R
(L031.101.R)

QUICK CHANGE DRILL HOLDERS

ART. L031

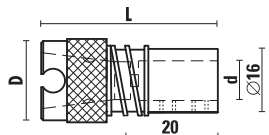

For: **MORBIDELLI** machines, with pull out spring

Item	d	D	L
L031.500.R	10	20	44



Z051.301.R

ADAPTORS

ART. L031

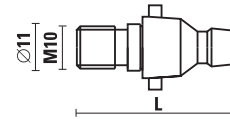

- Adaptor for quick change chucks
- For: **MORBIDELLI, SCM** with shank M10/11
- Use with: Art. L031.100.R and/or Art. L031.500.R

RH rotation	LH rotation	L
L031.600.R	L031.600.L	37

QUICK CHANGE DRILL HOLDERS

ART. L032

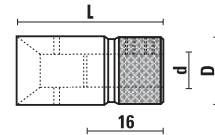

For: **MASTERWOOD, MAGGI, GRIGGIO**

Item	d	D	L
L032.100.R	10	20	40

For: **MINIMAX**

Item	d	D	L
L032.200.R	10	20	40



Z051.301.R

QUICK CHANGE DRILL HOLDERS

ART. L033

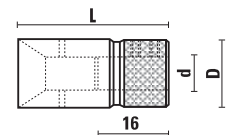

For: **VITAP**

Item	d	D	L
L033.100.R	10	18	42



Z051.313.R

QUICK CHANGE DRILL HOLDERS

ART. L034

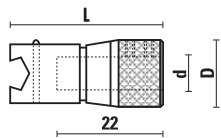

For: **BUSELLATO**

Item	d	D	L
L034.100.R	10	19	34,5



Z051.313.R

QUICK CHANGE DRILL HOLDERS

ART. L035

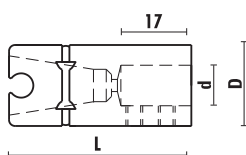

For: **DETEL**

Item	d	D	L
L035.100.R	10	20	45



Z051.314.R

QUICK CHANGE DRILL HOLDER

ART. L036

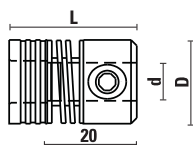

For: **GRASS**

Item	d	D	L
L036.100.R	10	22	38,5



Z051.304.R

CHUCKS FOR MACHINES "BIESSE" WITH AUTOMATIC CHANGE

ART. L060

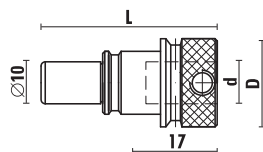

Item	d	D	L
L060.100.N	10	21	42



Z051.314.R

QUICK CHANGE DRILL HOLDERS

ART. L040

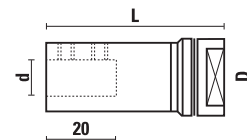

For: **WEEKE**

Item	d	D	L
L040.100.R	10	20	46
L040.101.R	10	20	56
L040.102.R	10	20	66



Z051.314.R

QUICK CHANGE CHUCKS

ART. L050

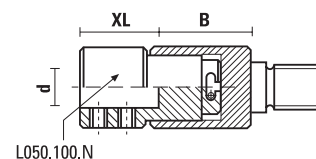
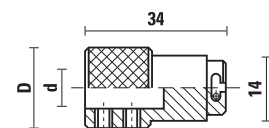

For art.: **L051 - L052 - L053 - L054**

Item	d	D	XL
L050.100.N	10	18	17,5



Z051.301.R

QUICK CHANGE CHUCKS

ART. L051

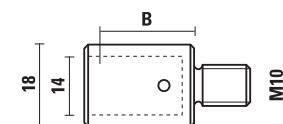

For: **AYEN, HOLZMA**

RH rotation	LH rotation	B
L051.100.R	L051.100.L	22,5

QUICK CHANGE CHUCKS

ART. L052

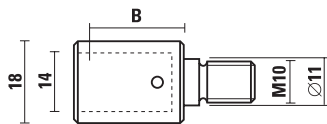

For: MORBIDELLI, BIESSE, WEEKE, BUSELLATO, TORWEGGE

RH rotation	LH rotation	B
L052.100.R	L052.100.L	22,5

QUICK CHANGE CHUCKS

ART. L053

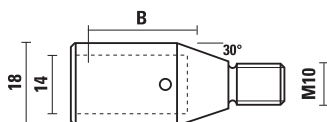

For: VITAP, ALBERTI

RH rotation	LH rotation	B
L053.100.R	L053.100.L	25,5

QUICK CHANGE CHUCKS

ART. L054

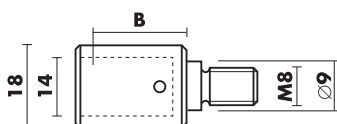

For: NOTTMEYER

RH rotation	LH rotation	B
L054.100.R	L054.100.L	25,5

HW DOWEL DRILLS Z=2

ART. L101 - L102

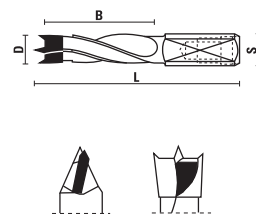

- 4-flutes
- Spurs ground with negative cutting angle for a good finish
- PTFE-Based coating for a better chip flow
- For natural wood, pressed wood, veneered, chipboard, laminated and MDF
- Can be used on **Mafell** drilling machines

RH rotation	LH rotation	D	B	L	S
L101.050.R	L101.050.L	5	30	55,5	8X20
L101.060.R	L101.060.L	6	30	55,5	8X20
L101.070.R	L101.070.L	7	30	55,5	8X20
L101.080.R	L101.080.L	8	30	55,5	8X20
L101.090.R	L101.090.L	9	30	55,5	8X20
L101.100.R	L101.100.L	10	30	55,5	8X20
L101.120.R	L101.120.L	12	30	55,5	8X20
L102.050.R	L102.050.L	5	40	67	8X20
L102.060.R	L102.060.L	6	40	67	8X20
L102.070.R	L102.070.L	7	40	67	8X20
L102.080.R	L102.080.L	8	40	67	8X20
L102.090.R	L102.090.L	9	40	67	8X20
L102.100.R	L102.100.L	10	40	67	8X20
L102.120.R	L102.120.L	12	40	67	8X20



Z051.302.R

HW THROUGH HOLES DRILL BITS Z=2

ART. L121 - L122

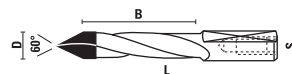

- 2-flutes
- PTFE-Based coating for a better chip flow
- For natural wood, pressed wood, veneered, chipboard, laminated and MDF

RH rotation	LH rotation	D	B	L	S
L121.050.R	L121.050.L	5	25	55,5	8X20
L121.080.R	L121.080.L	8	25	55,5	8X20
L122.050.R	L122.050.L	5	35	67	8X20
L122.080.R	L122.080.L	8	35	67	8X20



Z051.302.R

HW DOWEL DRILLS Z=2

ART. L109

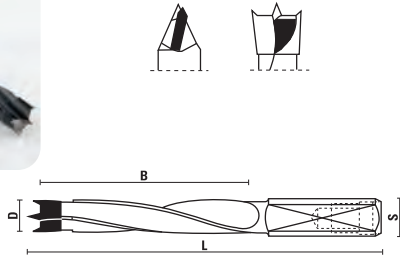

- 4-flutes
- Spurs ground with negative cutting angle for a good finish
- PTFE-Based coating for a better chip flow
- For natural wood, pressed wood, veneered, chipboard, laminated and MDF

RH rotation	LH rotation	D	B	L	S
L109.050.R	L109.050.L	5	45	85	10X30
L109.060.R	L109.060.L	6	45	85	10X30
L109.070.R	L109.070.L	7	45	85	10X30
L109.080.R	L109.080.L	8	45	85	10X30
L109.100.R	L109.100.L	10	45	85	10X30
L109.120.R	L109.120.L	12	45	85	10X30



Z051.302.R

On request



Z051.505.R

HW DOWEL DRILLS Z=2

ART. L110

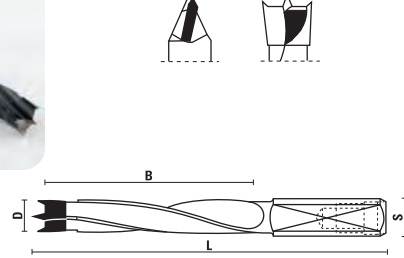

- 4-flutes
- Spurs ground with negative cutting angle for a good finish
- PTFE-Based coating for a better chip flow
- For natural wood, pressed wood, veneered, chipboard, laminated and MDF

RH rotation	LH rotation	D	B	L	S
L110.050.R	L110.050.L	5	65	105	10x30
L110.060.R	L110.060.L	6	65	105	10x30
L110.070.R	L110.070.L	7	65	105	10x30
L110.080.R	L110.080.L	8	65	105	10x30
L110.100.R	L110.100.L	10	65	105	10x30
L110.120.R	L110.120.L	12	65	105	10x30



Z051.302.R

On request



Z051.505.R

SPURS GEOMETRY OF THE DOWEL DRILLS

STANDARD ART. L101 ÷ L110	EXTRA FINE ART. L112 ÷ L113	EXTRA TIME ART. L114 ÷ L115	EXTRA TIME solid carbide ART. L116 ÷ L117
<p>Front Side</p> <ul style="list-style-type: none"> - Good finish - Average lifetime - Tungsten Carbide Tipped - P.T.F.E. coating - Lower price - For hard and soft wood, chipboard, laminated and MDF 	<p>Front Side</p> <ul style="list-style-type: none"> - Rounded and reinforced spurs with center point - Good finish - Good lifetime - Tungsten Carbide Tipped - P.T.F.E. coating - Medium price - For hard and soft wood, chipboard, laminated and MDF 	<p>Front Side</p> <ul style="list-style-type: none"> - Rounded and reinforced spurs with center point - Great finish without chipping - Very Good lifetime - Tungsten Carbide Tipped - P.T.F.E. coating - Medium price - For hard and soft wood, chipboard, laminated and MDF - Suitable also for Trespa and abrasive material 	<p>Front Side</p> <ul style="list-style-type: none"> - Rounded and reinforced spurs with center point - Excellent finish without chipping - Superior lifetime - Solid carbide/Mirror finish - Medium/high price - For hard and soft wood, chipboard, laminated and MDF - Suitable also for Trespa and abrasive material

EXTRA BORE ART. L116KD ÷ L117KD	FLAT BITS ART. L119	PKD ART. X530 ÷ X531
<p>Front Side</p> <ul style="list-style-type: none"> - Rounded and reinforced spurs with center point - Excellent finish without chipping - Premium lifetime (up to 4X times) - Solid carbide/Mirror finish - KleinDIA coating - High price - For hard and soft wood, chipboard, laminated and MDF - Suitable also for Trespa and abrasive material 	<p>Front Side</p> <ul style="list-style-type: none"> - Rounded spurs and flat center point - Excellent finish without chipping - Superior lifetime - Solid carbide/Mirror finish - Medium/high price - For low thickness panels of hard and soft wood, chipboard, laminated and MDF 	<p>Front Side</p> <ul style="list-style-type: none"> - Negative spurs and flat center point - Good finish without chipping - Excellent lifetime (up to 40X times) - Nickel coating against corrosion - Higher price - For very abrasive material and large scale industrial production

HW DOWEL DRILLS EXTRA FINE Z=2

ART. L112 - L113

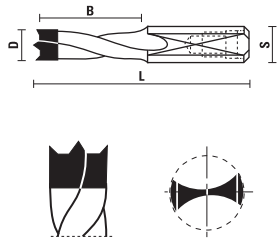

- EXTRA FINE GRINDING TOOL
- 2-flutes
- Rounded spurs and special HW for a better finish and longer lasting tool performance
- PTFE-Based coating for a better chip flow
- For natural wood, pressed wood, veneered, chipboard, laminated and MDF

RH rotation	LH rotation	D	B	L	S
L112.050.R	L112.050.L	5	27	57,5	10X27
L112.060.R	L112.060.L	6	27	57,5	10X27
L112.064.R	L112.064.L	6,4	27	57,5	10X27
L112.070.R	L112.070.L	7	27	57,5	10X27
L112.080.R	L112.080.L	8	27	57,5	10x27
L112.100.R	L112.100.L	10	27	57,5	10x27
L112.120.R	L112.120.L	12	27	57,5	10x27
L113.050.R	L113.050.L	5	35	70	10x30
L113.060.R	L113.060.L	6	35	70	10x30
L113.064.R	L113.064.L	6,4	35	70	10x30
L113.070.R	L113.070.L	7	35	70	10x30
L113.080.R	L113.080.L	8	35	70	10x30
L113.100.R	L113.100.L	10	35	70	10x30
L113.120.R	L113.120.L	12	35	70	10x30



Z051.302.R

On request Z051.505.R

HW AND SOLID CARBIDE DOWEL DRILLS (art. L112 - L113)

How to determine the feeding speed according to the machine (RPM):

- Referred to a standard common diameter

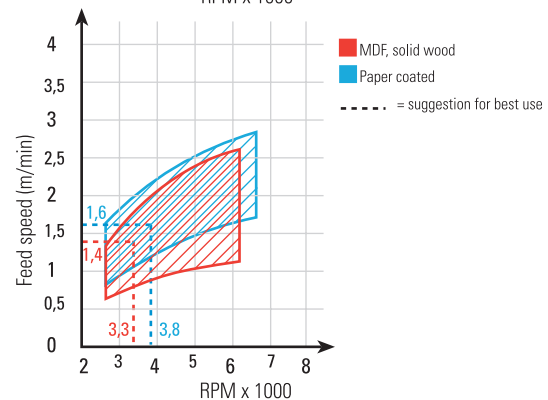
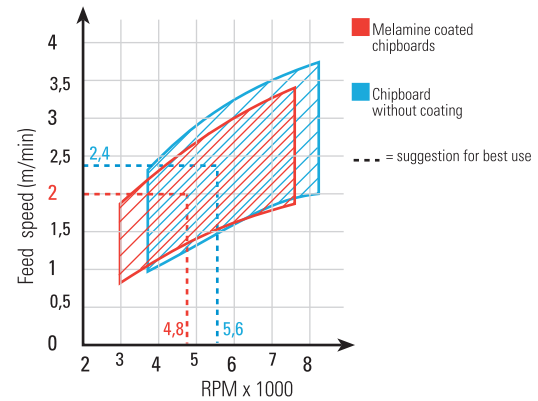

- High performance drills thanks to the special spur geometry;
- Suitable for working all materials with very good result;
- Suitable to work at higher feed speed and RPM.

HW AND SOLID CARBIDE DOWEL DRILLS (art. L114 - L115 - L116 - L117)

How to determine the feeding speed according to the machine (RPM):

- Referred to a standard common diameter

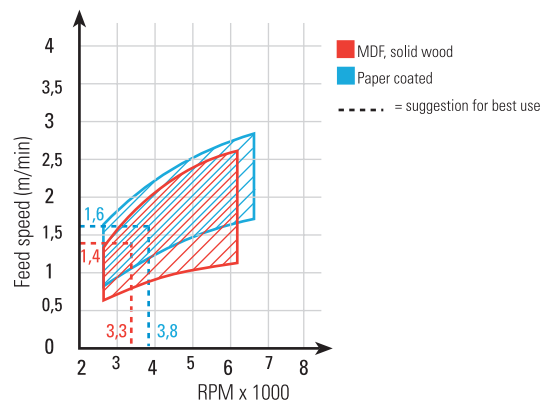
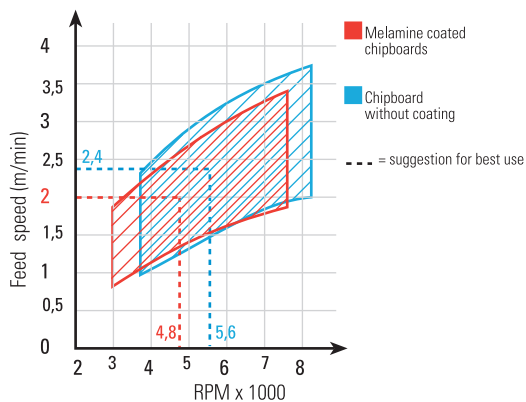

- Special spur geometry with reinforced centre point for excellent performance
- Recommended also for working problematic materials, like panels coated with paper
- Suitable to work at higher feed speed and RPM

HW DOWEL DRILLS EXTRA TIME Z=2

ART. L114 - L115

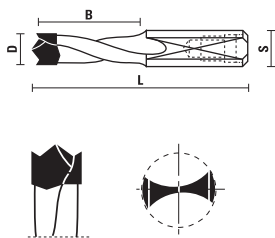

- EXTRA TIME GRINDING TOOL
- 2-flutes
- Rounded spurs and reinforced centre point
- Special HW
- Excellent finish and longer tool life
- PTFE-Based coating for a better chip flow
- For natural wood, pressed wood, veneered, chipboard, laminated and MDF
- Suggested also for working trespa and melamine panels

RH rotation	LH rotation	D	B	L	S
L114.050.R	L114.050.L	5	27	57,5	10X27
L114.060.R	L114.060.L	6	27	57,5	10x27
L114.064.R	L114.064.L	6,4	27	57,5	10x27
L114.070.R	L114.070.L	7	27	57,5	10x27
L114.080.R	L114.080.L	8	27	57,5	10x27
L114.100.R	L114.100.L	10	27	57,5	10x27
L114.120.R	L114.120.L	12	27	57,5	10x27
L115.050.R	L115.050.L	5	35	70	10x30
L115.060.R	L115.060.L	6	35	70	10x30
L115.064.R	L115.064.L	6,4	35	70	10x30
L115.070.R	L115.070.L	7	35	70	10x30
L115.080.R	L115.080.L	8	35	70	10x30
L115.100.R	L115.100.L	10	35	70	10x30
L115.120.R	L115.120.L	12	35	70	10x30



Z051.302.R

On request



Z051.505.R

VHW DOWEL DRILLS EXTRA TIME Z=2

ART. L116 - L117

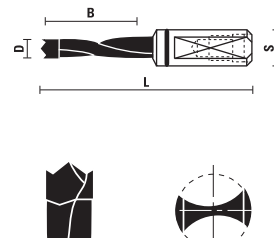

- EXTRA TIME GRINDING TOOL
- Solid carbide spiral portion with mirror finish quality
- 2-flutes
- Rounded spurs and reinforced centre point
- Special HW
- Excellent finish and longer tool life
- For natural wood, pressed wood, veneered, chipboard, laminated and MDF
- Suggested also for working trespa and melamine panels

RH rotation	LH rotation	D	B	L	S
L116.030.R	L116.030.L	3	20	57,5	10X32
L116.040.R	L116.040.L	4	23	57,5	10X27
L116.050.R	L116.050.L	5	23	57,5	10X27
L116.060.R	L116.060.L	6	23	57,5	10X27
L116.064.R	L116.064.L	6,4	23	57,5	10X27
L116.070.R	L116.070.L	7	23	57,5	10X27
L116.080.R	L116.080.L	8	23	57,5	10X27
L117.030.R	L117.030.L	3	20	70	10x38
L117.040.R	L117.040.L	4	30	70	10x30
L117.050.R	L117.050.L	5	30	70	10x30
L117.060.R	L117.060.L	6	30	70	10x30
L117.064.R	L117.064.L	6,4	30	70	10x30
L117.070.R	L117.070.L	7	30	70	10x30
L117.080.R	L117.080.L	8	30	70	10x30



Z051.302.R



Z059.001.L



Z059.001.R

On request



Z051.505.R

VHW DOWEL DRILLS Z=2, KleinDIA COATED

ART. L116.KD - L117.KD

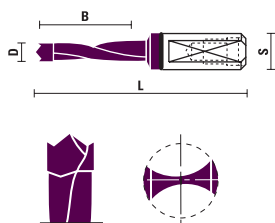

RH rotation	LH rotation	D	B	L	S
L116.030.RKD	L116.030.LKD	3	20	57,5	10X32
L116.040.RKD	L116.040.LKD	4	23	57,5	10X27
L116.050.RKD	L116.050.LKD	5	23	57,5	10X27
L116.060.RKD	L116.060.LKD	6	23	57,5	10X27
L116.080.RKD	L116.080.LKD	8	23	57,5	10X27
L117.030.RKD	L117.030.LKD	3	20	70	10x38
L117.040.RKD	L117.040.LKD	4	30	70	10x30
L117.050.RKD	L117.050.LKD	5	30	70	10x30
L117.060.RKD	L117.060.LKD	6	30	70	10x30
L117.080.RKD	L117.080.LKD	8	30	70	10x30



Z051.302.R



Z059.001.L



Z059.001.R

On request



Z051.505.R

- EXTRA TIME GRINDING TOOL (rounded spurs and reinforced centering point)
- Solid carbide spiral portion (with 2-flutes)
- Polished and coated cutting edge for improved chip evacuation and less friction
- Special HW more resistant
- Excellent finish and longer tool life for excellent performance
- For natural wood, pressed wood, veneered, chipboard, laminated and MDF
- Suggested also for working Trespa® and melamine panels

UP TO
4/6X
TOOL LIFE

THE NEW COATED BITS FOR
LARGE SCALE INDUSTRY

Xtra
bore

- DLC DIAMOND ANTIFRICTION COATING
- LONGER TOOL LIFE
- EXCELLENT PERFORMANCE ON EVERY KIND OF MATERIAL
- GREATER PRODUCTIVITY



VHW DOWEL DRILLS Z=2

ART. L118



- Solid carbide spiral portion
- 2-flutes
- For natural wood, pressed wood, veneered, chipboard, laminated and MDF
- Ideal for Trespa

RH rotation	LH rotation	D	B	L	S
L118.040.R	L118.040.L	4	32	70	10X30
L118.050.R	L118.050.L	5	32	70	10X30
L118.060.R	L118.060.L	6	32	70	10X30
L118.064.R	L118.064.L	6,4	32	70	10X30
L118.070.R	L118.070.L	7	32	70	10X30
L118.080.R	L118.080.L	8	32	70	10X30



Z051.302.R



Z059.001.L



Z059.001.R

On request



Z051.505.R

VHW DOWEL DRILLS Z=2

ART. L119

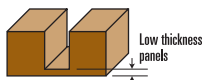
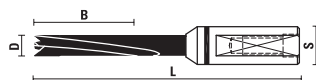

- Solid carbide spiral portion
- 2-flutes
- Flat center-point and two rounded spurs
- For natural wood, pressed wood, veneered, chipboard, laminated and MDF
- Best quality holes when working with low thickness panels thanks to the flat center-point and two rounded spurs

RH rotation	LH rotation	D	B	L	S
L119.050.R	L119.050.L	5	30	70	10x30
L119.080.R	L119.080.L	8	30	70	10x30



Z051.302.R

On request



Z051.505.R

DP DOWEL DRILLS

ART. X530 - X531

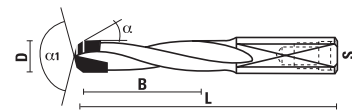

UP TO
30/50X
TOOL LIFE

- Shank with flat and screw
- Suitable for drilling very abrasive materials
- Used on CNC router machines

RH rotation	LH rotation	D	B	L	S	Z
X530.050.R	X530.050.L	5	27	57,5	10x26	2
X530.060.R	X530.060.L	6	27	57,5	10x26	2
X530.080.R	X530.080.L	8	27	57,5	10x26	2
X531.050.R	X531.050.L	5	35	70	10x30	2
X531.080.R	X531.080.L	8	35	70	10x30	2

VHW TWIST DRILLS Z=2

ART. L120



- Solid carbide
- 2-flutes
- For natural wood, pressed wood, veneered, chipboard, laminated and MDF
- Ideal for Trespa
- To use with adaptor bushes Art. Z010/Z011

RH rotation	LH rotation	D	B	L
L120.020.R	L120.020.L	2	18	49
L120.025.R	L120.025.L	2,5	22	55
L120.030.R	L120.030.L	3	22	55
L120.032.R	L120.032.L	3,2	22	55
L120.035.R	L120.035.L	3,5	25	55
L120.040.R	L120.040.L	4	25	55
L120.045.R	L120.045.L	4,5	28	58
L120.050.R	L120.050.L	5	28	58
L120.060.R	L120.060.L	6	28	58

VHW TWIST DRILLS (art. L120)

How to determine the feeding speed according to the machine (RPM):

- Referred to a standard common diameter

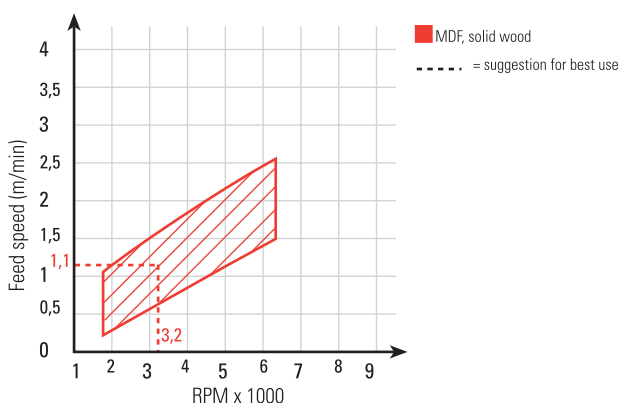
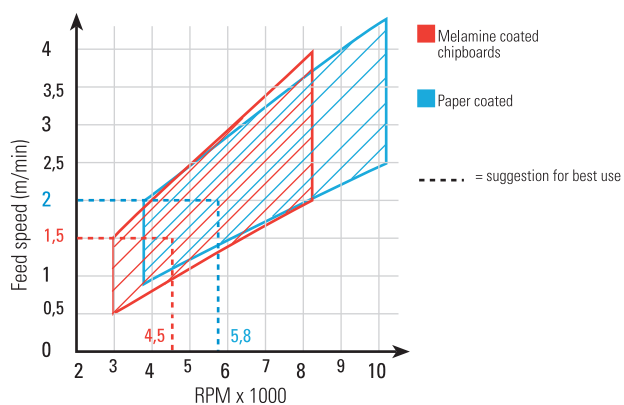

DRILL HOLDER-SLEEVES

ART. Z010

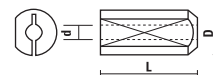

For Art. L120



Item	d	D	L
Z010.020.N	2	10	24
Z010.025.N	2,5	10	24
Z010.030.N	3	10	24
Z010.032.N	3,2	10	24
Z010.035.N	3,5	10	24
Z010.040.N	4	10	24
Z010.045.N	4,5	10	24
Z010.050.N	5	10	24
Z010.060.N	6	10	24

DRILL HOLDERS

ART. Z011

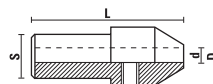

For Art. L120



Item	d	D	L	S
Z011.020.N	2	15	35	10x19
Z011.025.N	2,5	15	35	10x19
Z011.030.N	3	15	35	10x19
Z011.032.N	3,2	15	35	10x19
Z011.035.N	3,5	15	35	10x19
Z011.040.N	4	15	35	10x19
Z011.045.N	4,5	15	35	10x19
Z011.050.N	5	15	35	10x19
Z011.060.N	6	15	35	10x19

HW THROUGH HOLE DRILL BITS Z=2

ART. L123 - L124 - L125

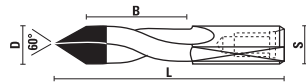

- 2-flutes

- PTFE-Based coating for a better chip flow
- For natural wood, pressed wood, veneered, chipboard, laminated and MDF

RH rotation	LH rotation	D	B	L	S
L123.040.R	L123.040.L	4	27	57,5	10X24
L123.050.R	L123.050.L	5	27	57,5	10X24
L123.060.R	L123.060.L	6	27	57,5	10X24
L123.070.R	L123.070.L	7	27	57,5	10X24
L123.080.R	L123.080.L	8	27	57,5	10X24
L123.090.R	L123.090.L	9	27	57,5	10X24
L123.100.R	L123.100.L	10	27	57,5	10X24
L124.040.R	L124.040.L	4	37	70	10X24
L124.050.R	L124.050.L	5	37	70	10X24
L124.060.R	L124.060.L	6	37	70	10X24
L124.064.R	L124.064.L	6,4	37	70	10X24
L124.070.R	L124.070.L	7	37	70	10X24
L124.080.R	L124.080.L	8	37	70	10X24
L124.090.R	L124.090.L	9	37	70	10X24
L124.095.R	L124.095.L	9,5	37	70	10X24
L124.100.R	L124.100.L	10	37	70	10X24
L124.120.R	L124.120.L	12	37	70	10X24
L125.050.R	L125.050.L	5	45	77	10X24
L125.060.R	L125.060.L	6	45	77	10X24
L125.070.R	L125.070.L	7	45	77	10X24
L125.080.R	L125.080.L	8	45	77	10X24
L125.100.R	L125.100.L	10	45	77	10X24



Z051.302.R



Z051.505.R

HW THROUGH HOLE DRILL BITS Z=2

ART. L126 - L127

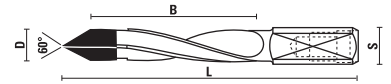

- 4-flutes

- PTFE-Based coating for a better chip flow
- For natural wood, pressed wood, veneered, chipboard, laminated and MDF

RH rotation	LH rotation	D	B	L	S
L126.050.R	L126.050.L	5	27	57,5	10X20
L126.060.R	L126.060.L	6	27	57,5	10X20
L126.080.R	L126.080.L	8	27	57,5	10X20
L127.045.R	L127.045.L	4,5	40	70	10X20
L127.050.R	L127.050.L	5	40	70	10X20
L127.055.R	L127.055.L	5,5	40	70	10X20
L127.060.R	L127.060.L	6	40	70	10X20
L127.070.R	L127.070.L	7	40	70	10X20
L127.080.R	L127.080.L	8	40	70	10X20
L127.090.R	L127.090.L	9	40	70	10X20
L127.100.R	L127.100.L	10	40	70	10X20
L127.120.R	L127.120.L	12	40	70	10X20



Z051.302.R



On request Z051.505.R

HW THROUGH HOLE DOWEL DRILLS WITH 2 AND 4 FLUTES (from art. L121 to L127)

How to determine the feeding speed according to the machine (RPM):
 • Referred to a standard common diameter

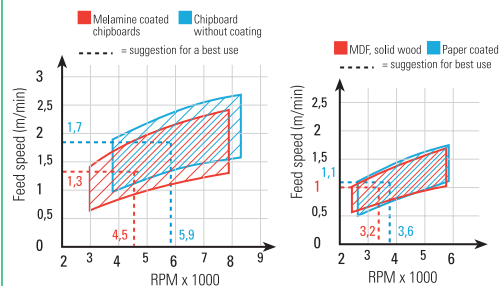

- Finish quality will be improved reducing the feed before the drill exit from the panel bottom side
- The solid carbide drills art. L129 allow the same results at higher feed speed and RPM

GRINDING GEOMETRY OF THE THROUGH HOLE DRILL BITS

STANDARD ART. L123 ÷ L127	STANDARD solid carbide ART. L129	EXTRA TIME ART. L132 - L133	EXTRA TIME solid carbide ART. L134 - L135	EXTRA BORE ART. L134KD - L135KD	DP (PCD) ART. X532 - X533
<ul style="list-style-type: none"> - 60° drill point - Good finish and average lifetime - Tungsten Carbide Tipped with P.T.F.E. coating - Lower price - For hard and soft wood, chipboard, laminated and MDF 	<ul style="list-style-type: none"> - 60° drill point - Good finish and great lifetime - Solid Carbide & Mirror finish - Medium/High price - For hard and soft wood, chipboard, laminated and MDF - Suitable also for Trespa and abrasive material 	<ul style="list-style-type: none"> - Double angle grinding geometry - Great performance and very good lifetime - Tungsten Carbide Tipped with P.T.F.E. coating - Medium price - For hard and soft wood, chipboard, laminated and MDF 	<ul style="list-style-type: none"> - Double angle grinding geometry - Excellent performance and lifetime - Solid Carbide & Mirror finish - Medium/High price - For hard and soft wood, chipboard, laminated and MDF - Suitable also for Trespa and abrasive material 	<ul style="list-style-type: none"> - Double angle grinding geometry - Premium finish and lifetime (up to 4X times) - Solid carbide with KleinDIA coating - High price - For hard and soft wood, chipboard, laminated and MDF - Suitable also for Trespa and abrasive material 	<ul style="list-style-type: none"> - Double angle grinding geometry - Good finish and excellent lifetime (up to 40X times) - Nickel coating against corrosion - Higher price - For very abrasive material and large scale industrial production

VHW THROUGH HOLE DRILL BITS Z=2

ART. L129

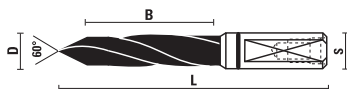

- Solid carbide spiral portion (with 2-flutes)
- For natural wood, pressed wood, veneered, chipboard, laminated and MDF
- Made with an exclusive carbide and a **mirror finish quality**. This process will reduce the friction and produce clean and smooth cuts with longer tool life and better performances.
- Best choice when working panels with special coating

RH rotation	LH rotation	D	B	L	S
L129.030.R	L129.030.L	3	20	70	10x30
L129.040.R	L129.040.L	4	30	70	10x30
L129.050.R	L129.050.L	5	30	70	10x30
L129.060.R	L129.060.L	6	30	70	10x30
L129.080.R	L129.080.L	8	30	70	10x30



Z051.302.R



Z059.001.L



Z059.001.R

On request



Z051.505.R

VHW THROUGH HOLE DRILL BITS Z=2,

Klein^{DIA} COATED

ART. L129.KD

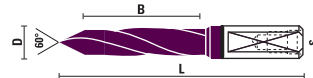

Xtra[®]
bore

UP TO
4/6X
TOOL LIFE

- Solid carbide spiral portion (with 2-flutes)
- Excellent finish and longer tool life
- Polished and coated cutting edge for improved chip evacuation and less friction
- For natural wood, pressed wood, veneered, chipboard, laminated and MDF
- Best choice when working panels with special coating

RH rotation	LH rotation	D	B	L	S
L129.050.RKD	L129.050.LKD	5	30	70	10x30



Z051.302.R



Z059.001.L



Z059.001.R

On request



Z051.505.R

THE NEW COATED BITS FOR LARGE SCALE INDUSTRY

Xtra[®]
bore

- DLC DIAMOND ANTIFRICTION COATING
- LONGER TOOL LIFE
- EXCELLENT PERFORMANCE ON EVERY KIND OF MATERIAL
- GREATER PRODUCTIVITY

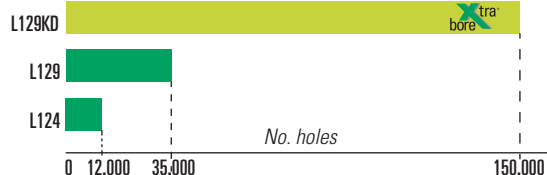

DP THROUGH-HOLE DRILL BITS

ART. X532 - X533

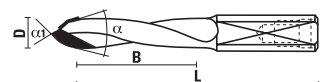

UP TO
30/50X
TOOL LIFE

- Shank with flat and screw
- Suitable for drilling very abrasive materials
- Used on CNC router machines

RH rotation	LH rotation	D	B	L	S	Z
X532.050.R	X532.050.L	5	27	57,5	10x26	1
X533.050.R	X533.050.L	5	35	70	10x26	1
X533.060.R	X533.060.L	6	35	70	10x26	2
X533.080.R	X533.080.L	8	35	70	10x26	2

VISIT OUR WEBSITE

www.sistemklein.com



HW COUNTERSINKS Z=2 - 90°

ART. L130

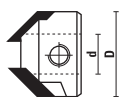

- For 4 Flutes drills:
Articles L103, L104, M101, M102, M103, M121, M122, M123, N101, N111, N135, N136
- Adjustable on the cutting length

RH rotation	LH rotation	d	D
L130.040.R	L130.040.L	4	15,5
L130.050.R	L130.050.L	5	15,5



Z051.303.R

L130.060.R	L130.060.L	6	15,5
L130.064.R	L130.064.L	6,4	15,5
L130.070.R	L130.070.L	7	18
L130.080.R	L130.080.L	8	18
L130.090.R	L130.090.L	9	18
L130.100.R	L130.100.L	10	20
L130.120.R	L130.120.L	12	22



Z051.300.R

HW COUNTERSINKS Z=2 - 90°

ART. L131



- For Articles L105, L106, L107, L108
- To be mounted on the shank \varnothing 10

RH rotation	LH rotation	d	D
L131.100.R	L131.100.L	5/10	20
L131.120.R	L131.120.L	11/12	22



Z051.304.R

VHW DOWEL DRILLS FOR BOTH RIGHT HAND AND LEFT HAND ROTATION Z=1

ART. L136 - L137

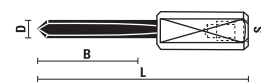

- Solid carbide spiral portion
- Straight cutting edges
- Can be used on either right and left rotation chucks
- Ideal for drilling highly **abrasive material**

Item	D	B	L	S
L136.020.N	2	12	57,5	10x33
L136.025.N	2,5	15	57,5	10x33
L136.030.N	3	16	57,5	10x30
L136.035.N	3,5	18	57,5	10x30
L136.040.N	4	20	57,5	10x30
L136.050.N	5	25	57,5	10x25
L136.060.N	6	25	57,5	10x25
L136.080.N	8	25	57,5	10x25
L137.020.N	2	12	70	10x33
L137.025.N	2,5	12	70	10x33
L137.030.N	3	24	70	10x30
L137.035.N	3,5	30	70	10x30
L137.040.N	4	32	70	10x30
L137.050.N	5	35	70	10x25
L137.060.N	6	35	70	10x25
L137.080.N	8	35	70	10x25



Z051.302.R

On request Z051.505.R

HW DOWEL DRILLS WITH COUNTERSINK Z=2

ART. L138 - L139

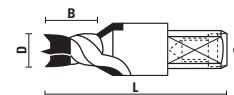

- Spurs ground with negative cutting angle for a good finish
- Cylindrical shank with flat/screw

RH rotation	LH rotation	D	B	L	S
L138.080.R	L138.080.L	8	12	57,5	10x20
L138.081.R	L138.081.L	8	15	57,5	10x20
L138.082.R	L138.082.L	8	20	57,5	10x20
L138.100.R	L138.100.L	10	12	57,5	10x20
L138.101.R	L138.101.L	10	15	57,5	10x20
L138.102.R	L138.102.L	10	20	57,5	10x20
L139.080.R	L139.080.L	8	12	70	10x20
L139.081.R	L139.081.L	8	15	70	10x20
L139.082.R	L139.082.L	8	20	70	10x20
L139.100.R	L139.100.L	10	12	70	10x20
L139.101.R	L139.101.L	10	15	70	10x20
L139.102.R	L139.102.L	10	20	70	10x20



Z051.302.R

HW THROUGH HOLE DRILL BITS "E.T." LINE Z=2

ART. L132 - L133

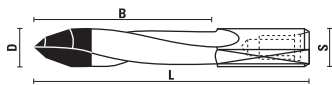

- **EXTRA TIME GRINDING TOOL**
- High performance with the special **double angle grinding geometry for smoother cuts**
- **PTFE**-Based coating for a better chip flow
- For **natural wood, pressed wood, veneered, chipboard, laminated and MDF**
- With height adjustment screw. On request it is possible to have the special screw for the Weeke Machines (Art. Z051.505.R)

RH rotation	LH rotation	D	B	L	S
L132.050.R	L132.050.L	5	30	58	10x24
L132.060.R	L132.060.L	6	30	58	10x24
L132.080.R	L132.080.L	8	30	58	10x24
L133.040.R	L133.040.L	4	36	70	10x24
L133.050.R	L133.050.L	5	36	70	10x24
L133.060.R	L133.060.L	6	36	70	10x24
L133.064.R	L133.064.L	6,4	36	70	10x24
L133.070.R	L133.070.L	7	36	70	10x24
L133.080.R	L133.080.L	8	36	70	10x24
L133.100.R	L133.100.L	10	36	70	10x24
L133.120.R	L133.120.L	12	36	70	10x24



Z051.302.R

On request



Z051.505.R

HW AND VH W THROUGH HOLE DOWEL DRILLS "E.T." EXTRA TIME (art. L132 - L133)

How to determine the feeding speed according to the machine (RPM):

- Referred to a standard common diameter

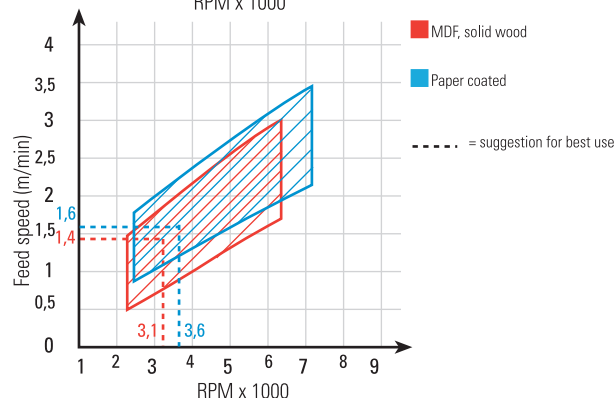
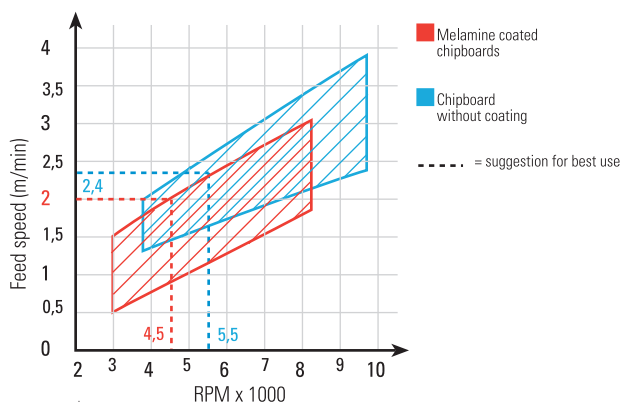

- Excellent finish result at high feed speed
- Use the solid carbide drills art. L134-L135 for the same result at higher feed speed and RPM

VHW THROUGH HOLE DRILL BITS "E.T." LINE Z=2

ART. L134 - L135



- **EXTRA TIME GRINDING TOOL**
- Made with an exclusive carbide and a mirror finish quality. This process will reduce the friction and produce clean and smooth cuts with longer tool life and better performances
- Solid carbide spiral portion
- High performance with the special **double angle grinding geometry for smoother cuts**
- For natural wood, pressed wood, veneered, chipboard, laminated and MDF
- With height adjustment screw. On request it is possible to have the special screw for the Weeke Machines (Art. Z051.505.R)

RH rotation	LH rotation	D	B	L	S
L134.050.R	L134.050.L	5	28	58	10x20
L134.060.R	L134.060.L	6	28	58	10x20
L134.080.R	L134.080.L	8	28	58	10x20
L135.040.R	L135.040.L	4	40	70	10x20
L135.050.R	L135.050.L	5	40	70	10x20
L135.060.R	L135.060.L	6	40	70	10x20
L135.064.R	L135.064.L	6,4	40	70	10x20
L135.070.R	L135.070.L	7	40	70	10x20
L135.080.R	L135.080.L	8	40	70	10x20



Z051.302.R



Z059.001.L



Z059.001.R

On request



Z051.505.R

VHW THROUGH HOLE DRILL BITS Z=2 "E.T." LINE, Klein^{DA} COATED

ART. L134.KD - L135.KD

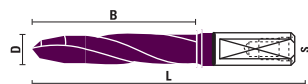

UP TO
4/6X
TOOL LIFE

- **EXTRA TIME** grinding tool (**high performance** thanks to the double angle geometry)
- **Solid carbide spiral portion** (with 2 flutes)
- **Polished and coated cutting edge for improved chip evacuation and less friction**
- **Excellent finish and longer tool life**
- **High performance** thanks to its double angle geometry
- **Special HW** more resistant
- For natural and pressed wood, veneered and laminated panels, chipboard and MDF



RH rotation	LH rotation	D	B	L	S
L134.050.RKD	L134.050.LKD	5	28	58	10x20
L134.080.RKD	L134.080.LKD	8	28	58	10x20
L135.040.RKD	L135.040.LKD	4	40	70	10x20
L135.050.RKD	L135.050.LKD	5	40	70	10x20
L135.060.RKD	L135.060.LKD	6	40	70	10x20
L135.080.RKD	L135.080.LKD	8	40	70	10x20



Z051.302.R



Z059.001.L



Z059.001.R

On request



Z051.505.R

HW HINGE BORING BITS Z=2+2

ART. L140 - L141

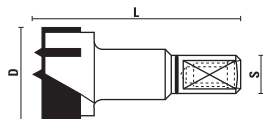

For natural and pressed woods, chipboards, veneered and laminate coated panels and MDF

RH rotation	LH rotation	D	L	S
L140.140.R	L140.140.L	14	57	10X26
L140.150.R	L140.150.L	15	57	10X26
L140.160.R	L140.160.L	16	57	10X26
L140.170.R	L140.170.L	17	57	10X26
L140.180.R	L140.180.L	18	57	10X26
L140.190.R	L140.190.L	19	57	10X26
L140.200.R	L140.200.L	20	57	10X26
L140.220.R	L140.220.L	22	57	10X26
L140.240.R	L140.240.L	24	57	10X26
L140.250.R	L140.250.L	25	57	10X26
L140.260.R	L140.260.L	26	57	10X26
L140.280.R	L140.280.L	28	57	10X26
L140.300.R	L140.300.L	30	57	10X26
L140.320.R	L140.320.L	32	57	10X26
L140.340.R	L140.340.L	34	57	10X26
L140.350.R	L140.350.L	35	57	10X26
L140.360.R	L140.360.L	36	57	10X26
L140.380.R	L140.380.L	38	57	10X26
L140.400.R	L140.400.L	40	57	10X26

L141.140.R	L141.140.L	14	70	10X26
L141.150.R	L141.150.L	15	70	10X26
L141.160.R	L141.160.L	16	70	10X26
L141.180.R	L141.180.L	18	70	10X26
L141.200.R	L141.200.L	20	70	10X26
L141.220.R	L141.220.L	22	70	10X26
L141.250.R	L141.250.L	25	70	10X26
L141.260.R	L141.260.L	26	70	10X26
L141.300.R	L141.300.L	30	70	10X26
L141.340.R	L141.340.L	34	70	10X26
L141.350.R	L141.350.L	35	70	10X26
L141.400.R	L141.400.L	40	70	10X26



HW HINGE BORING BITS Z=2+2

ART. L142

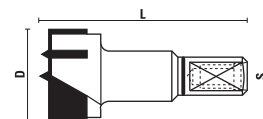

For natural and pressed woods, chipboards, veneered and laminate coated panels and MDF

RH rotation	LH rotation	D	L	S
L142.200.R	L142.200.L	20	77	10X26
L142.250.R	L142.250.L	25	77	10X26
L142.300.R	L142.300.L	30	77	10X26
L142.350.R	L142.350.L	35	77	10X26



HW HINGE BORING BITS Z=2+2

ART. L150 - L151

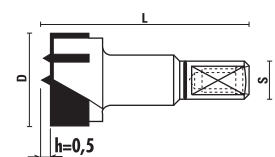

- Centerpoint H=0,5 mm for thin boards (16 mm)
- For natural and pressed woods, chipboards, veneered and laminate coated panels and MDF

RH rotation	LH rotation	D	L	S
L150.150.R	L150.150.L	15	56	10X26
L150.200.R	L150.200.L	20	56	10X26
L150.350.R	L150.350.L	35	56	10X26
L151.150.R	L151.150.L	15	70	10X26
L151.200.R	L151.200.L	20	70	10X26
L151.350.R	L151.350.L	35	70	10X26



SPURS GEOMETRY OF THE HINGE BORING BITS

STANDARD Z=2+2 ART. L140 - L141



- Two cutting edges, two negative ground spurs and center point
- Good finish and lifetime
- Tungsten Carbide Tipped with P.T.F.E. coating
- Lower price
- For hard and soft wood, chipboard, laminated and MDF

STANDARD Z=3+3 ART. L143



- Three cutting edges, three ground spurs and center point (0,5 mm)
- Great finish and lifetime
- Tungsten Carbide Tipped with P.T.F.E. coating
- Medium price
- For hard and soft wood, chipboard, laminated and MDF

STANDARD Z=3+3 ART. L144



- Three cutting edges and three ground spurs (without centre point)
- Great finish and lifetime
- Tungsten Carbide Tipped with P.T.F.E. coating
- Medium price
- For hard and soft wood, chipboard, laminated and MDF

Solid carbide Z=2+2 ART. L155 - L156



- Two cutting edges, two rounded spurs and center point
- Excellent finish and superior lifetime
- Solid carbide & Mirror finish
- High price
- For hard and soft wood, chipboard, laminated, MDF and plastic coated panels.

PCD DIAMOND Z=2+2 ART. X540 - X541



- Two cutting edges, two negative ground spurs and center point
- Good finish and excellent lifetime (up to 40X times)
- Nickel coating against corrosion
- Higher price
- For very abrasive material and large scale industrial production

HW HINGE BORING BITS Z=3+3

ART. L143 - L144

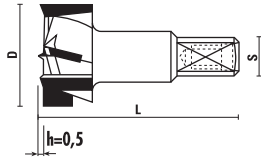

Centerpoint H=0,5 mm

RH rotation	LH rotation	D	L	S
L143.250.R	L143.250.L	25	57,5	10x26
L143.260.R	L143.260.L	26	57,5	10x26
L143.300.R	L143.300.L	30	57,5	10x26
L143.350.R	L143.350.L	35	57,5	10x26
L143.400.R	L143.400.L	40	57,5	10x26



Z051.302.R



Without centerpoint

RH rotation	LH rotation	D	L	S
L144.250.R	L144.250.L	25	57,5	10x26
L144.260.R	L144.260.L	26	57,5	10x26
L144.300.R	L144.300.L	30	57,5	10x26
L144.350.R	L144.350.L	35	57,5	10x26



Z051.302.R

HW HINGE BORING BITS Z=3+3 (art. L143-L144)

How to determine the feeding speed according to the machine (RPM):

- Referred to a standard common diameter

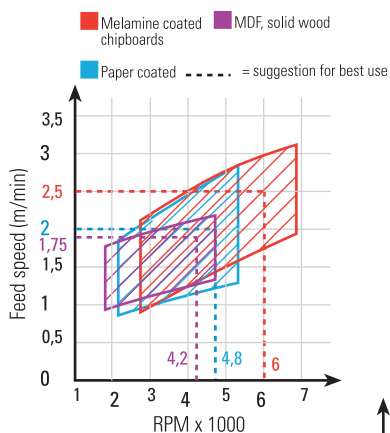

VHW HINGE BORING BITS Z=2+2 (art. L155-L156)

How to determine the feeding speed according to the machine (RPM):

- Referred to a standard common diameter

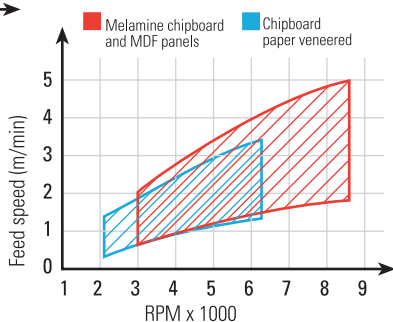

VHW HINGE BORING BITS Z=2+2

ART. L155 - L156

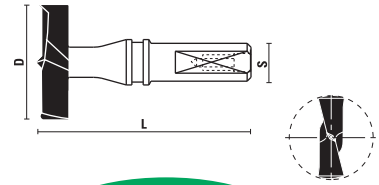

HIGHEST PERFORMANCE

- Solid carbide
- Rounded spurs for an excellent finish
- Highest performance also in extreme conditions
- For high precision bores for hinges
- Ideal for hard and soft wood, chipboard, MDF, veneered and plastic coated boards

RH rotation	LH rotation	D	L	S
L155.150.R	L155.150.L	15	57	10x26
L155.200.R	L155.200.L	20	57	10x26
L155.250.R	L155.250.L	25	57	10x26
L155.300.R	L155.300.L	30	57	10x26
L155.350.R	L155.350.L	35	57	10x26
L156.150.R	L156.150.L	15	70	10x26
L156.200.R	L156.200.L	20	70	10x26
L156.250.R	L156.250.L	25	70	10x26
L156.300.R	L156.300.L	30	70	10x26
L156.350.R	L156.350.L	35	70	10x26



Z051.302.R

DP HINGE BORING BITS

ART. X540 - X541

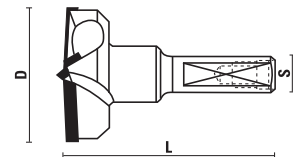

UP TO 30/50X TOOL LIFE

- Shank with flat and screw
- HW centerpoint
- Suitable for drilling very abrasive materials
- Used on CNC router machines

RH rotation	LH rotation	D	L	S	Z
X540.150.R	X540.150.L	15	56	10x26	2+2
X540.160.R	X540.160.L	16	56	10x26	2+2
X540.180.R	X540.180.L	18	56	10x26	2+2
X540.200.R	X540.200.L	20	56	10x26	2+2
X540.250.R	X540.250.L	25	56	10x26	2+2
X540.260.R	X540.260.L	26	56	10x26	2+2
X540.300.R	X540.300.L	30	56	10x26	2+2
X540.350.R	X540.350.L	35	56	10x26	2+2
X540.400.R	X540.400.L	40	56	10x26	2+2
X541.150.R	X541.150.L	15	70	10x26	2+2
X541.200.R	X541.200.L	20	70	10x26	2+2
X541.250.R	X541.250.L	25	70	10x26	2+2
X541.350.R	X541.350.L	35	70	10x26	2+2

HW HINGE BORING BITS Z=2+2

ART. L160

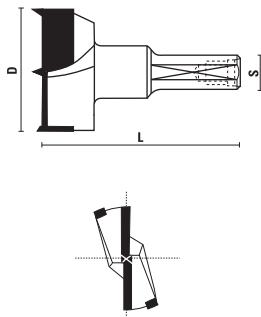

To be used on Trimatic 22-25-28

RH rotation	LH rotation	D	L	S
L160.300.R	L160.300.L	30	57	10X26
L160.340.R	L160.340.L	34	57	10X26



Z051.302.R

HW HINGE BORING BITS Z=2+2

ART. L170

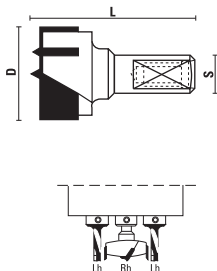

To be used on Trimatic Super

RH rotation	LH rotation	D	L	S
L170.200.R	L170.200.L	20	38,5	10X22
L170.260.R		26	38,5	10X22
L170.350.R	L170.350.L	35	38,5	10X22
L170.400.R		40	38,5	10X22



Z051.302.R

HW DOWEL DRILLS Z=2

ART. L171

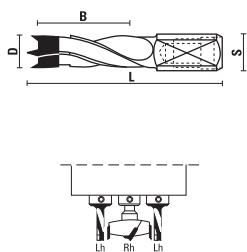

- To be used on Trimatic Super
- PTFE-Based coating for a better chip flow
- For natural and pressed woods, chipboards and laminate coated panels

RH rotation	LH rotation	D	B	L	S
L171.050.R	L171.050.L	5	18	38,5	10X18
L171.080.R	L171.080.L	8	18	38,5	10X18
L171.100.R	L171.100.L	10	18	38,5	10X18



Z051.302.R

HW DRILLS FOR CABINEO® Z=2

ART. L174



L174.150.R



L174.150.L

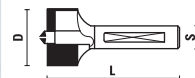

To be used on Trimatic 22,4 for Cabineo®

RH rotation	LH rotation	D	L	S
L174.150.R	L174.150.L	15	35	6



Z051.302.R

HW DOWEL DRILLS FOR "CABINEO"® Z=2

ART. L175

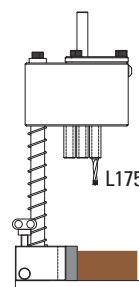
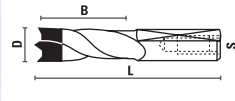

- 2 flutes drill bits
- To equip both Trimatic 22,4 and Trimatic Super 22,4 for Lamello Cabineo®
- Lh rotation
- Equip Trimatic 22,4 with one of the drill bits L175.050.L for "Cabineo 8" or L175.051.L for "Cabineo 12" to make ø 5 mm blind holes to fix Lamello Cabineo® connections

LH rotation	D	B	L	S
L175.050.L	5	8	35	ø6x20
L175.051.L	5	12	35	ø6x20



TRIMATIC 22,4 FOR "LAMELLO"® CABINEO®"



trimatic®

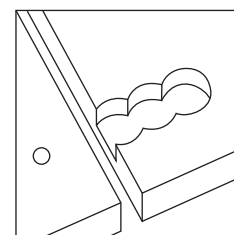

See catalogue section 16

HW DOWEL DRILLS WITH THREADED SHANK Z=2

ART. M101 - M102 - M103

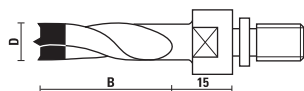

- 4-flutes
- M10/11x4 for:
MORBIDELLI - BIESSE - WEEKE

RH rotation	LH rotation	D	B
M101.050.R	M101.050.L	5	30
M101.060.R	M101.060.L	6	30
M101.080.R	M101.080.L	8	30
M101.100.R	M101.100.L	10	30
M101.120.R	M101.120.L	12	30
M101.140.R	M101.140.L	14	30

M102.050.R	M102.050.L	5	40
M102.060.R	M102.060.L	6	40
M102.080.R	M102.080.L	8	40
M102.100.R	M102.100.L	10	40
M102.120.R	M102.120.L	12	40
M102.140.R	M102.140.L	14	40

M103.050.R	M103.050.L	5	50
M103.060.R	M103.060.L	6	50
M103.080.R	M103.080.L	8	50
M103.100.R	M103.100.L	10	50
M103.120.R	M103.120.L	12	50
M103.140.R	M103.140.L	14	50

HW DOWEL DRILLS WITH COUNTERSINK THREADED SHANK Z=2

ART. M111 - M112 - M113



- 2-flutes
- M10/11x4 for:
MORBIDELLI - BIESSE - WEEKE

RH rotation	LH rotation	D	B
M111.050.R	M111.050.L	5	30
M111.060.R	M111.060.L	6	30
M111.080.R	M111.080.L	8	30
M111.100.R	M111.100.L	10	30
M111.120.R	M111.120.L	12	30
M111.140.R	M111.140.L	14	30
M111.160.R	M111.160.L	16	30

M112.050.R	M112.050.L	5	40
M112.060.R	M112.060.L	6	40
M112.080.R	M112.080.L	8	40
M112.100.R	M112.100.L	10	40
M112.120.R	M112.120.L	12	40
M112.140.R	M112.140.L	14	40
M112.160.R	M112.160.L	16	40

M113.050.R	M113.050.L	5	50
M113.060.R	M113.060.L	6	50
M113.080.R	M113.080.L	8	50
M113.100.R	M113.100.L	10	50
M113.120.R	M113.120.L	12	50
M113.140.R	M113.140.L	14	50
M113.160.R	M113.160.L	16	50

HW DOWEL DRILLS WITH THREADED SHANK Z=2

ART. M121 - M122 - M123

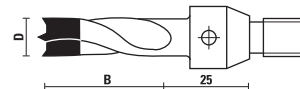

- 4-flutes
- M10/30° for: **VITAP - BUSELLATO - SCHLEICHER**

RH rotation	LH rotation	D	B
M121.050.R	M121.050.L	5	30
M121.060.R	M121.060.L	6	30
M121.080.R	M121.080.L	8	30
M121.100.R	M121.100.L	10	30
M121.120.R	M121.120.L	12	30
M121.140.R	M121.140.L	14	30

M122.050.R	M122.050.L	5	40
M122.060.R	M122.060.L	6	40
M122.080.R	M122.080.L	8	40
M122.100.R	M122.100.L	10	40
M122.120.R	M122.120.L	12	40
M122.140.R	M122.140.L	14	40

M123.050.R	M123.050.L	5	50
M123.060.R	M123.060.L	6	50
M123.080.R	M123.080.L	8	50
M123.100.R	M123.100.L	10	50
M123.120.R	M123.120.L	12	50
M123.140.R	M123.140.L	14	50

HW DOWEL DRILLS WITH COUNTERSINK THREADED SHANK Z=2

ART. M132

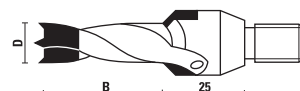

- 2-flutes
- M10/30° for: **VITAP - BUSELLATO - SCHLEICHER**

RH rotation	LH rotation	D	B
M132.050.R	M132.050.L	5	40
M132.060.R	M132.060.L	6	40
M132.080.R	M132.080.L	8	40
M132.100.R	M132.100.L	10	40
M132.120.R	M132.120.L	12	40
M132.140.R	M132.140.L	14	40
M132.160.R	M132.160.L	16	40

HW HINGE BORING BITS WITH THREADED SHANK Z=2

ART. M141 - M142

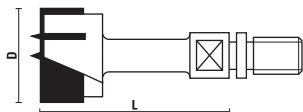

M10/11x4 for: **MORBIDELLI - BIESSE - WEEKE**

RH rotation	LH rotation	D	L
M141.200.R	M141.200.L	20	40
M141.250.R	M141.250.L	25	40
M141.350.R	M141.350.L	35	40
M142.350.R	M142.350.L	35	55
M142.400.R	M142.400.L	40	55

HW HINGE BORING BITS WITH THREADED SHANK Z=2+2

ART. M151

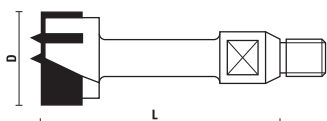

M10/30° for: **VITAP - BUSELLATO - SCHLEICHER**

RH rotation	LH rotation	D	L
M151.250.R	M151.250.L	25	65
M151.260.R	M151.260.L	26	65
M151.350.R	M151.350.L	35	65
M151.400.R	M151.400.L	40	65

HW HINGE BORING BITS WITH THREADED SHANK Z=2+2

ART. N131

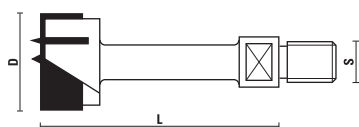

- M8 for: **NOTTMEYER**
- M10 for: **AYEN**

RH rotation	LH rotation	D	L	S
N131.200.R	N131.200.L	20	63	M10
N131.250.R	N131.250.L	25	63	M10
N131.350.R	N131.350.L	35	63	M10

HW DOWEL DRILLS WITH THREADED SHANK Z=2

ART. N101 - N111

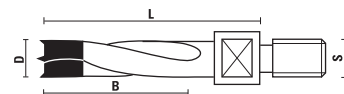

- 4-flutes
- M8 for: **NOTTMEYER**
- M10 for: **AYEN**

RH rotation	LH rotation	D	B	L	S
N101.050.R	N101.050.L	5	43	63	M8
N101.060.R	N101.060.L	6	43	63	M8
N101.080.R	N101.080.L	8	43	63	M8
N101.100.R	N101.100.L	10	43	63	M8
N101.120.R	N101.120.L	12	43	63	M8
N111.050.R	N111.050.L	5	43	63	M10
N111.060.R	N111.060.L	6	43	63	M10
N111.080.R	N111.080.L	8	43	63	M10
N111.100.R	N111.100.L	10	43	63	M10
N111.120.R	N111.120.L	12	43	63	M10

HW DOWEL DRILLS WITH THREADED SHANK Z=2

ART. N135 - N136

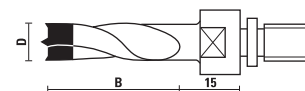

- 4-flutes
- M8/9x4 for: **MORBIDELLI, NOTTMEYER, MASTERWOOD**

RH rotation	LH rotation	D	B
N135.050.R Selling out	N135.050.L Selling out	5	40
N135.060.R Selling out	N135.060.L Selling out	6	40
N135.080.R Selling out	N135.080.L Selling out	8	40
N135.100.R Selling out	N135.100.L Selling out	10	40
N135.120.R Selling out	N135.120.L Selling out	12	40
N136.050.R	N136.050.L	5	60
N136.060.R	N136.060.L	6	60
N136.080.R	N136.080.L	8	60
N136.100.R	N136.100.L	10	60
N136.120.R	N136.120.L	12	60

BORING BITS AND SLOT MORTISING BITS FOR PORTABLE DRILLS



HW FLAT COUNTERSINKS Z=2
Page 6.03



HW SPIRAL BITS Z=2
Page 6.03



HW COUNTERSINK Z=2 - 30°
Page 6.03



HW SPIRAL BITS Z=2
Page 6.03



HS COUNTERSINKS Z=2
Page 6.03



HS BRAD POINT DRILLS Z=2
Page 6.04



SP BRAD POINT DRILLS Z=2
Page 6.04

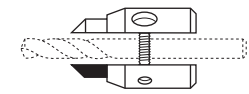

HW ADJUSTABLE COUNTERSINK Z=2
Page 6.04



SP BRAD POINT DRILLS Z=2
Page 6.04



SP SINGLE FLUTE DRILLS "LEWIS" TYPE Z=1
Page 6.05



HS SPIRAL BITS Z=2
Page 6.05



HS SPIRAL BITS Z=2
Page 6.05



HS STEP DRILLS Z=2
Page 6.05



HS STEP DRILLS Z=2
Page 6.06



HW/HS 3-DIAMETER BITS
"CONFIRMAT" Z=2
Page 6.06



HW/HS 3-DIAMETER DRILLS,
ADJUSTABLE Z=2
Page 6.06



HS TWIST DRILLS Z=2
Page 6.06

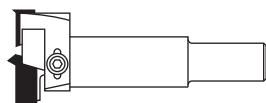

HW ADJUSTABLE DIAMETER
BORING BITS 30/60 MM
Page 6.07

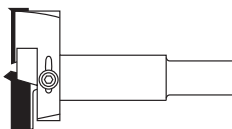

HW ADJUSTABLE DIAMETER BORING
BITS 60/80 MM
Page 6.07

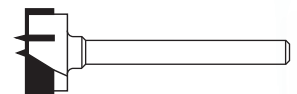

HW HINGE BORING BITS Z=2+2
Page 6.07

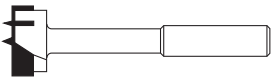

HW HINGE BORING BITS Z=2+2
Page 6.08

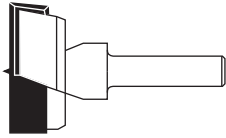

HW BORING BITS
Page 6.08

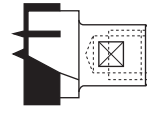

HW INTERCHANGEABLE HINGE BORING BITS Z=2+2
Page 6.08

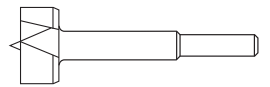

SP "FORSTNER" BITS Z=2+2
Page 6.09

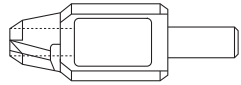

SP PLUG CUTTERS
Page 6.09

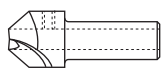

HW/HS COUNTERSINKS Z=2
Page 6.09

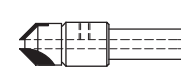

HW COUNTERSINKS 45° Z=2 WITH SHANK S=8
Pag. 6.10

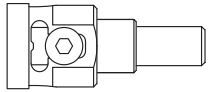

ADJUSTABLE DEPTH STOPPER
Page 6.10

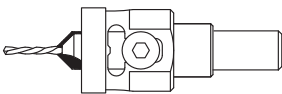

ADJUSTABLE COUNTERSINK SET
Page 6.10



HW COUNTERSINKS 45° Z=2 WITH HEX SHANK
Page 6.11

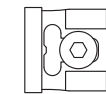

ADJUSTABLE DEPTH STOPPER
Page 6.11

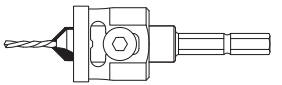

ADJUSTABLE COUNTERSINK SET
Page 6.11

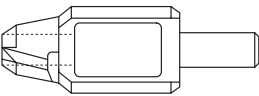

HS PLUG CUTTERS Z=1
Page 6.11



HS SPIRAL BITS Z=2
Page 6.11

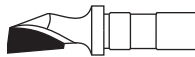

HW/HS DOVETAIL BITS 9° - Z=1
Page 6.12



VHW DOVETAIL BITS Z=2
Page 6.12

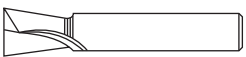

HW/HS DOVETAIL BITS Z=2
Page 6.12



SP SLOT MORTISING BITS WITH CHIPBREAKER Z=2
Page 6.12



HL RECIPROCATING SLOT MORTISING BITS
Page 6.13



HL RECIPROCATING SLOT MORTISING BITS Z=3
Page 6.13



HW RECIPROCATING SLOT MORTISING BITS
Page 6.13



HW/SP GROOVING CUTTERS Z=2
Page 6.13



HW/SP SLOT MORTISING CUTTERS Z=2
Page 6.13



HW/SP BORING BITS Z=2
Page 6.14

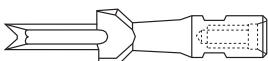

HW/SP SLOT BORING BITS Z=2
Page 6.14



HS CUTTERS FOR COPYING LATHES
Page 6.14

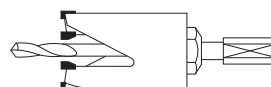

HW HOLE SAWS
Page 6.14

HW FLAT COUNTERSINKS Z=2

ART. R100

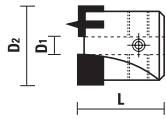

- Use with Art. R101 and with T.C.T. dowel drills Art. L103 - L104 L109 - L110 and with all dowel drills with 4 flutes



RH rotation	LH rotation	D1	D2	L
R100.050.R	R100.050.L	5	16	20
R100.060.R	R100.060.L	6	16	20
R100.061.R	R100.061.L	6	20	20
R100.070.R	R100.070.L	7	20	20
R100.080.R	R100.080.L	8	16	20
R100.081.R	R100.081.L	8	19	20
R100.082.R	R100.082.L	8	20	20
R100.090.R	R100.090.L	9	19	20
R100.091.R	R100.091.L	9	20	20
R100.100.R	R100.100.L	10	20	20
R100.101.R	R100.101.L	10	25	20
R100.102.R	R100.102.L	10	30	20
R100.120.R	R100.120.L	12	25	20
R100.121.R	R100.121.L	12	30	20

HW SPIRAL BITS Z=2

ART. R101

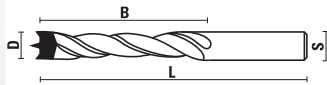

- 4-flutes
- Use rings Art. Z003 page 10.03



RH rotation	D	B	L
R101.050.R	5	50	85
R101.060.R	6	55	90
R101.070.R	7	65	105
R101.080.R	8	75	115
R101.090.R	9	80	125
R101.100.R	10	90	135
R101.120.R	12	100	150

HW COUNTERSINKS Z=2 - 30°

ART. R102



- Use with T.C.T. dowel drills Art. L103 - L104 - L109 - L110 and with all dowel drills with 4 flutes



RH rotation	D1	D2	α
R102.080.R	8	19	30°

HW SPIRAL BITS Z=2

ART. R125

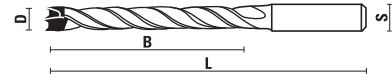

- 4-flutes
- Use rings Art. Z003 page 10.03



RH rotation	D	B	L	S
R125.060.R	6	75	140	13x50
R125.080.R	8	85	150	13x50
R125.100.R	10	95	160	13x50
R125.120.R	12	105	170	13x50
R125.130.R	13	110	175	13x50
R125.140.R	14	115	180	13x50
R125.150.R	15	120	185	13x50
R125.160.R	16	125	190	16x50
R125.180.R	18	130	200	16x50
R125.200.R	20	140	210	16x50

HS COUNTERSINKS Z=2

ART. R200

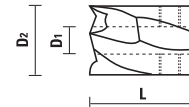

For Art. R201



RH rotation	D1	D2	L
R200.040.R	4	10	22
R200.050.R	5	12	22
R200.051.R	5	15	22
R200.060.R	6	15	22
R200.061.R	6	16	22
R200.062.R	6	20	22
R200.080.R	8	16	22
R200.081.R	8	20	22
R200.082.R	8	22	22
R200.083.R	8	25	22
R200.100.R	10	20	22
R200.101.R	10	25	25
R200.102.R	10	30	25
R200.120.R	12	25	25
R200.121.R	12	30	25

R200.910.R Set with 6 countersinks Ø 5/15 - 6/15 - 6/20 - 8/20 - 8/25 - 10/25 + 4 brad point drills Ø 5 - 6 - 8 - 10

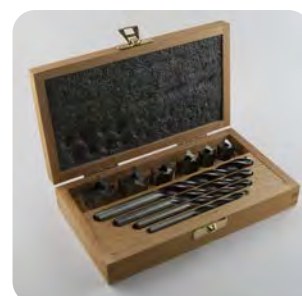

HS BRAD POINT DRILLS Z=2

ART. R201

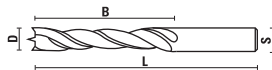

- 4-flutes
- Use rings Art. Z003 page 10.03



RH rotation	D	B	L
R201.060.R	6	55	95
R201.065.R	6,5	65	105
R201.070.R	7	70	110
R201.075.R	7,5	70	115
R201.080.R	8	75	120
R201.090.R	9	80	130
R201.100.R	10	90	140
R201.110.R	11	95	150
R201.120.R	12	100	155

SP BRAD POINT DRILLS Z=2

ART. R205



2-flutes



RH rotation	D	B	L	S
R205.030.R	3	33	60	3
R205.040.R	4	43	75	4
R205.050.R	5	52	85	5
R205.060.R	6	57	93	6
R205.070.R	7	69	109	7
R205.080.R	8	75	117	8
R205.090.R	9	81	125	9
R205.100.R	10	87	133	10
R205.111.R	11	94	150	10
R205.120.R	12	101	155	10
R205.130.R	13	101	155	10
R205.140.R	14	108	170	10
R205.150.R	15	114	170	10
R205.160.R	16	120	180	10
R205.180.R	18	130	200	10
R205.200.R	20	130	200	10
R205.220.R	22	140	210	13
R205.240.R	24	140	215	13
R205.260.R	26	140	215	13
R205.280.R	28	140	220	13
R205.300.R	30	140	220	13

R205.505.R 5 drills set Ø 4 -5 -6 -8 -10

R205.508.R 8 drills set Ø 3 -4 -5 -6 -7 -8 -9 -10

HW ADJUSTABLE COUNTERSINKS Z=2

ART. A199

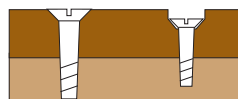
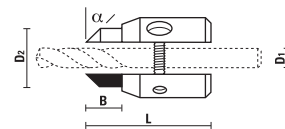

Spare key supplied; single packed

Item	D1	D2	α	B	L
A199.030.R	3/7	11/15	45°	12	32
A199.060.R	6/10	15,5/19,5	45°	12	34

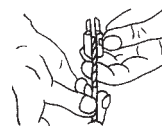

Insert the tool



Adjust the boring depth



Line up the cutting edges of countersink and tool

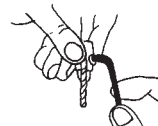

Tighten the screws

SP BRAD POINT DRILLS Z=2

ART. R206

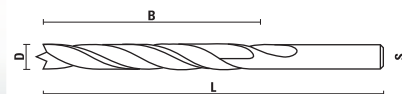

- 2-flutes
- For wall brackets, girders



RH rotation	D	B	L	S
R206.080.R	8	160	245	8
R206.090.R	9	160	245	9
R206.100.R	10	160	245	10
R206.120.R	12	160	245	10
R206.121.R	12	250	400	10
R206.140.R	14	160	245	10
R206.141.R	14	250	400	10
R206.160.R	16	160	245	10
R206.161.R	16	250	400	10
R206.180.R	18	160	245	10
R206.181.R	18	250	400	10
R206.200.R	20	160	245	10
R206.201.R	20	250	400	10

SP SINGLE FLUTE DRILLS "LEWIS" TYPE Z=1

ART. R207

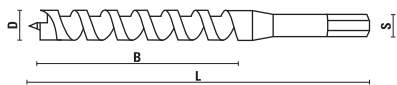

Hex shank



RH rotation	D	B	L	S
R207.080.R	8	220	300	8
R207.100.R	10	220	300	10
R207.120.R	12	220	300	10
R207.140.R	14	220	300	10
R207.150.R	15	220	300	10
R207.160.R	16	220	300	10
R207.180.R	18	220	300	13
R207.200.R	20	220	300	13
R207.220.R	22	220	300	13
R207.240.R	24	220	300	13
R207.250.R	25	220	300	13
R207.260.R	26	220	300	13
R207.280.R	28	220	300	13
R207.300.R	30	220	300	13

HS SPIRAL BITS Z=2

ART. R225



4-flutes



RH rotation	D	B	L	S
R225.060.R	6	75	140	13x50
R225.080.R	8	85	150	13x50
R225.100.R	10	95	160	13x50
R225.120.R	12	105	170	13x50
R225.130.R	13	110	175	13x50
R225.140.R	14	115	180	13x50
R225.160.R	16	125	190	16x50
R225.180.R	18	130	200	16x50
R225.200.R	20	140	210	16x50
R225.220.R	22	150	220	16x50
R225.240.R	24	160	235	16x50
R225.250.R	25	170	250	20x50
R225.300.R	30	190	270	20x50

HS SPIRAL BITS Z=2

ART. R226



4-flutes



RH rotation	D	B	L	S
R226.110.R	11	100	140	10x30
R226.120.R	12	100	140	10x30
R226.130.R	13	100	140	10x30
R226.140.R	14	100	140	10x30
R226.150.R	15	100	140	10x30
R226.160.R	16	100	140	10x30
R226.180.R	18	100	140	10x30
R226.200.R	20	100	140	10x30

HS STEP DRILLS Z=2

ART. R202

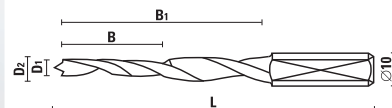

- S=∅10 flat on the shank
- For **Masterwood** machines



RH rotation	D1	D2	B	B1	L	Anuba
R202.090.R	3,8	5	20	40	75	9
R202.110.R	4,2	5,7	20	45	80	11
R202.130.R	5,2	6,5	15	50	85	13
R202.140.R	5,5	7	15	55	90	14
R202.160.R	6	7,7	15	60	95	16
R202.180.R	6,6	8,2	20	70	105	18
R202.200.R	7,2	8,7	20	80	115	20



HS STEP DRILLS Z=2

ART. R203

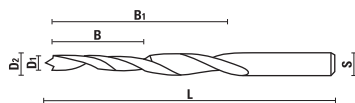

Shank throughout cylindrical



RH rotation	D1	D2	B	B1	L	S	Anuba
R203.130.R	5,4	6,5	20	50	80	6,5	13
R203.131.R	5,7	6,75	20	65	105	6,75	13
R203.140.R	6	7	20	50	80	7	14
R203.141.R	6,25	7,25	25	60	90	7,25	14
R203.142.R	6,25	7,25	20	65	105	7,25	14
R203.160.R	6,5	7,75	25	60	90	7,75	16
R203.161.R	6,5	7,75	20	70	110	7,75	16
R203.180.R	6,7	8,5	25	60	90	8,5	18
R203.181.R	6,7	8,5	25	70	110	8,5	18

HW/HS 3-DIAMETER BITS "CONFIRMAT" Z=2

ART. R104 - R204

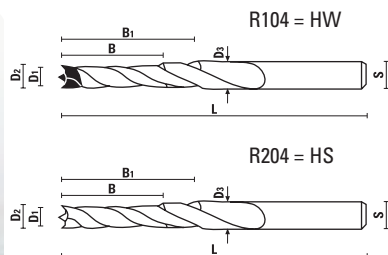

- For "Confirmat" joints
- R104 = HW
- R204 = HS



RH rotation	D1	D2	D3	B	B1	L	Mat.	S
R104.100.R	5,5	7,3	10	35	56	138	HW	10x50
R204.100.R	5,5	7,3	10	35	56	138	HS	10x50
R204.101.R	5,5	7,3	10	40	60	120	HS	10x40

HW/HS 3-DIAMETER DRILLS, ADJUSTABLE Z=2

ART. R108 - R209

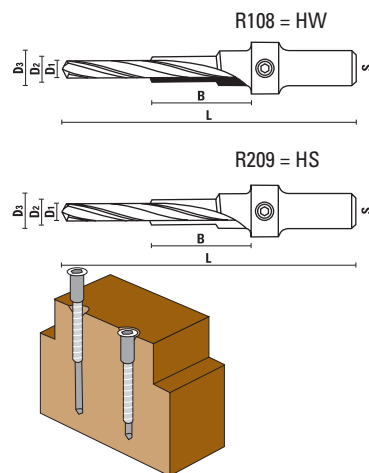

- 3 Steps drill bits
- For mounting joints screws
- HS spare drills
- For mounting connecting screws "Confirmat", "Directa" etc..



RH rotation	D1	D2	D3	B	L	Mat.	S
R108.050.R	5	8,5	11,5	25	100	HW	10
R209.035.R	3,5	5	8	24	90	HS	10
R209.044.R	4,4	6,5	9,5	18	95	HS	10
R209.050.R	5	7	10	26	100	HS	10

Spare drill bit	D
R108.051.R	5
R209.036.R	3,5
R209.045.R	4,4
R209.051.R	5

HS TWIST DRILLS Z=2

ART. R208

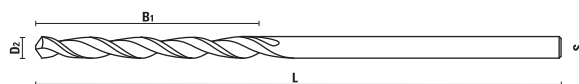

Anuba 9÷11 No step drills

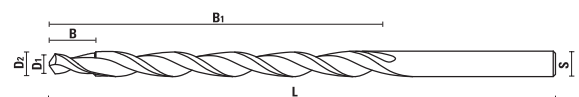

Anuba 13÷22 Step drills

For Anuba SFS INTECK



RH rotation	D1	D2	B1	B	L	S	Anuba
R208.090.R		5,2	52		132	5,2	9
R208.110.R		5,7	57		139	5,7	11
R208.130.R	5,3	6,7	63	12	148	6,7	13
R208.140.R	5,8	7,2	69	13	156	7,2	14
R208.160.R	6,3	7,7	75	14	165	7,7	16
R208.180.R	7,2	8,6	81	14	175	8,6	18
R208.200.R	7,4	8,8	81	16	175	8,8	20
R208.220.R	8,8	10,2	87	23	184	10,2	22

HW ADJUSTABLE DIAMETER BORING BITS 30/60 MM

ART. R110

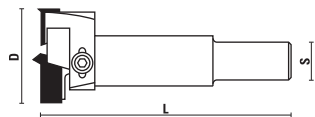

Complete with 1 knife \varnothing 30÷45 mm + 1 knife \varnothing 45÷60 + key



RH rotation	D	L	S
R110.600.R	30÷60	90	10x30

Spare knife

R110.300.N	30÷45
R110.450.N	45÷60



Z051.012.R

HW ADJUSTABLE DIAMETER BORING BITS 60/80 MM

ART. R110

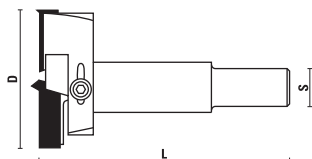

Complete with 1 knife \varnothing 60÷80 + key



RH rotation	D	L	S
R110.800.R	60÷80	100	12x40

Spare knife

R110.801.R	60÷80
------------	-------



Z051.013.R



HW HINGE BORING BITS Z=2+2

ART. R111



For soft and hard wood, plywood and laminated chipboard



RH rotation	D	L	S
R111.140.R	14	90	10x60
R111.141.R	14	120	10x100
R111.150.R	15	90	10x60
R111.151.R	15	120	10x100
R111.160.R	16	90	10x60
R111.161.R	16	120	10x100
R111.170.R	17	90	10x60
R111.180.R	18	90	10x60
R111.181.R	18	120	10x100
R111.190.R	19	90	10x60
R111.200.R	20	90	10x60
R111.201.R	20	120	10x100
R111.210.R	21	90	10x60
R111.220.R	22	90	10x60
R111.221.R	22	120	10x100
R111.230.R	23	90	10x60
R111.240.R	24	90	10x60
R111.250.R	25	90	10x60
R111.251.R	25	120	10x100
R111.260.R	26	90	10x60
R111.261.R	26	120	10x100
R111.270.R	27	90	10x60
R111.280.R	28	90	10x60
R111.300.R	30	90	10x60
R111.301.R	30	120	10x100
R111.320.R	32	90	10x60
R111.340.R	34	90	10x60
R111.350.R	35	90	10x60
R111.351.R	35	120	10x100
R111.360.R	36	90	10x60
R111.380.R	38	90	10x60
R111.400.R	40	90	10x60
R111.401.R	40	120	10x100
R111.420.R	42	90	10x60
R111.450.R	45	90	10x60
R111.480.R	48	90	10x60
R111.500.R	50	90	10x60
R111.550.R	55	90	10x60
R111.600.R	60	90	10x60

R111.905.R 5 drills set \varnothing 15 -20 -25 -30 -35



HW HINGE BORING BITS Z=2+2

ART. R112

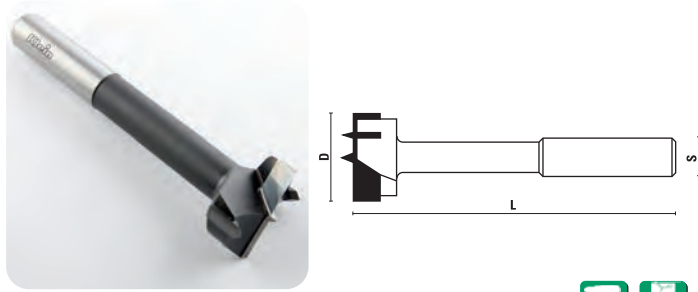

For soft and hard wood, plywood and laminated chipboard



RH rotation	D	L	S
R112.150.R	15	120	13x50
R112.160.R	16	120	13x50
R112.200.R	20	120	13x50
R112.220.R	22	130	13x50
R112.240.R	24	130	13x50
R112.250.R	25	130	13x50
R112.260.R	26	130	13x50
R112.280.R	28	130	13x50
R112.300.R	30	130	13x50
R112.320.R	32	130	16x50
R112.350.R	35	130	16x50
R112.400.R	40	130	16x50
R112.450.R	45	130	16x50
R112.500.R	50	130	16x50
R112.550.R	55	140	16x50
R112.600.R	60	140	16x50
R112.650.R	65	140	16x50
R112.700.R	70	140	16x50
R112.800.R	80	140	20x50
R112.900.R	90	140	20x50

T.C.T. HINGE BORING BITS Z=2+2 (art. R111-R112)

How to determine the feeding speed according to the machine (RPM):

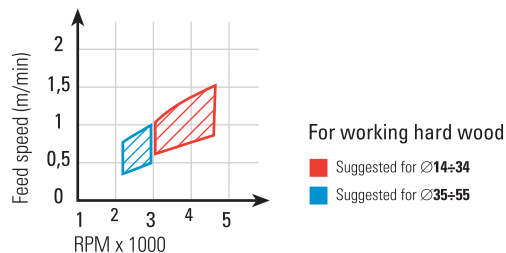

HW BORING BITS

ART. C192

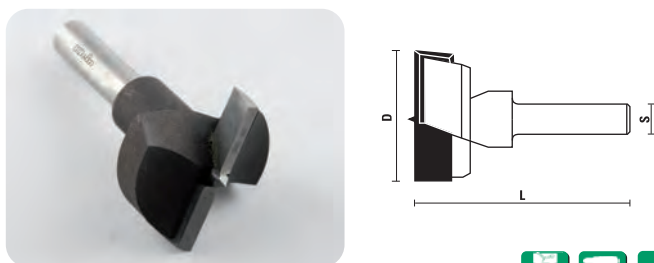

Without spurs



S Ø 8	D	L
C192.250.R	25	57
C192.260.R	26	57
C192.300.R	30	57
C192.350.R	35	57

HW INTERCHANGEABLE HINGE BORING BITS Z=2+2

ART. R130



Use with Art. Z021 page 10.04, 10.05



RH rotation	LH rotation	D	L
R130.200.R	R130.200.L	20	30
R130.250.R	R130.250.L	25	30
R130.260.R	R130.260.L	26	30
R130.280.R	R130.280.L	28	30
R130.300.R	R130.300.L	30	30
R130.320.R	R130.320.L	32	30
R130.340.R	R130.340.L	34	30
R130.350.R	R130.350.L	35	30
R130.360.R	R130.360.L	36	30
R130.380.R	R130.380.L	38	30
R130.400.R	R130.400.L	40	30
R130.450.R		45	30
R130.480.R		48	30
R130.500.R		50	30
R130.550.R		55	30
R130.600.R		60	30
R130.650.R		65	30
R130.700.R		70	30

Art. Z021 see section Spare parts page (Section 10)

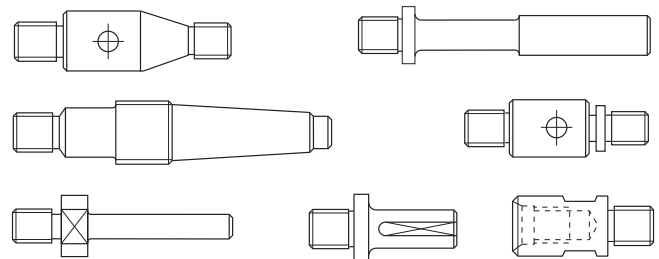

VISIT OUR WEBSITE
www.sistemiklein.com



SP "FORSTNER" BITS Z=2+2

ART. R213

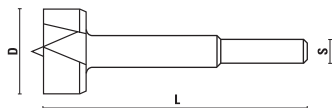

For soft and hard wood



RH rotation	D	L	S
R213.100.R	10	90	8x30
R213.120.R	12	90	8x30
R213.140.R	14	90	8x30
R213.150.R	15	90	8x30
R213.160.R	16	90	8x30
R213.180.R	18	90	8x30
R213.200.R	20	90	8x30
R213.220.R	22	90	8x30
R213.240.R	24	90	8x30
R213.250.R	25	90	8x30
R213.260.R	26	90	8x30
R213.280.R	28	90	8x30
R213.300.R	30	90	8x30
R213.320.R	32	90	10x30
R213.340.R	34	90	10x30
R213.350.R	35	90	10x30
R213.360.R	36	90	10x30
R213.380.R	38	90	10x30
R213.400.R	40	90	10x30
R213.450.R	45	90	10x30
R213.500.R	50	90	10x30

R213.905.R 5 boring bits set Ø 15 - 20 - 25 - 30 - 35

R213.915.R 15 boring bits set Ø 10 - 12 - 15 - 16 - 18 - 20 - 22 - 25 - 26 - 28 - 30 - 35 - 40 - 45 - 50



R213.905.R



R213.915.R

SP PLUG CUTTERS

ART. R220

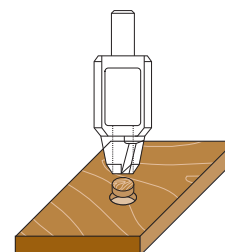
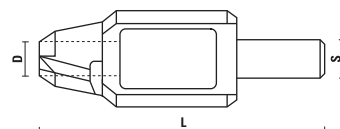

For soft and hard wood



RH rotation	D	L	S	Z
R220.080.R	8	140	13x50	4
R220.100.R	10	140	13x50	4
R220.120.R	12	140	13x50	4
R220.150.R	15	140	13x50	4
R220.200.R	20	140	13x50	4
R220.250.R	25	140	13x50	5
R220.300.R	30	140	13x50	5
R220.350.R	35	140	16x50	6
R220.400.R	40	140	16x50	6

HW/HS COUNTERSINKS Z=2

ART. R150 - R250

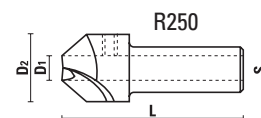
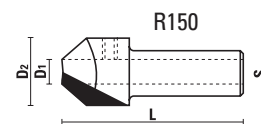

RH rotation	LH rotation	D1	D2	L	S	Mat.
R150.030.R	R150.030.L	3	15	40	10x25	HW
R150.040.R	R150.040.L	4	15	40	10x25	HW
R150.050.R	R150.050.L	5	15	40	10x25	HW
R150.060.R	R150.060.L	6	15	40	10x25	HW
R250.030.R	R250.030.L	3	15	40	10x25	HS
R250.040.R	R250.040.L	4	15	40	10x25	HS
R250.050.R	R250.050.L	5	15	40	10x25	HS
R250.060.R	R250.060.L	6	15	40	10x25	HS

ADJUSTABLE COUNTERSINK SET

Thanks to our new solution, it is now possible to adjust drilling depth and make seats for flush screws in an easy and quick manner, simply by using a power portable drill. You can find below the directions of use for the two different solutions both with cylindrical and hex shank. It is very important to drill a pilot hole before inserting the screw, in order to obtain excellent results, both aesthetic and long-lasting performance.

HOW TO USE WITH CYLINDRICAL SHANK



HOW TO USE WITH HEX SHANK

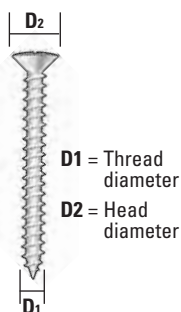
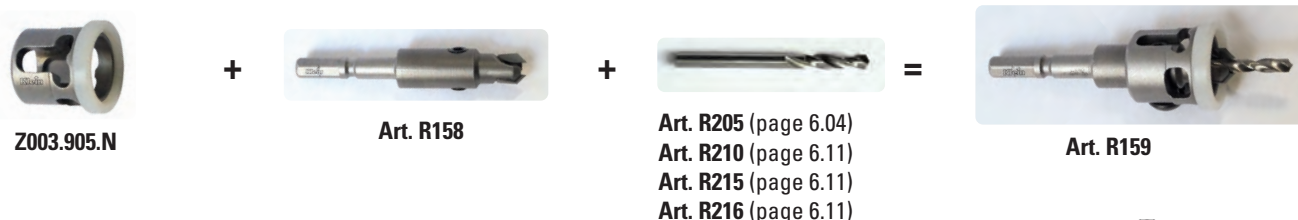

Pilot hole dimensions will be changed based on the type of wood to drill. For drilling soft wood, consider a smaller hole - roughly 10% - compared to hard wood

D2	D1	Soft wood	Hard wood
7	3,5	∅ drill bit 2,4	∅ drill bit 2,8
8	4	∅ drill bit 2,8	∅ drill bit 3,2
8,9	4,5	∅ drill bit 3,2	∅ drill bit 3,5
9,6	5	∅ drill bit 3,5	∅ drill bit 4

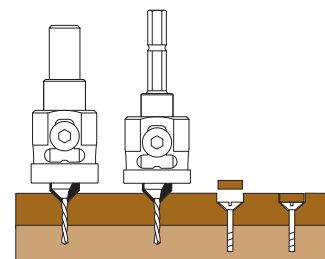

HW COUNTERSINKS 45° Z=2 WITH SHANK S=8

ART. R155

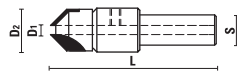

RH rotation	D1	D2	L	S
R155.030.R	3	10	44	8
R155.035.R	3,5	10	44	8
R155.040.R	4	10	44	8
R155.050.R	5	10	44	8



Z051.324.R



Z052.006.N

ADJUSTABLE DEPTH STOPPER

ART. Z003

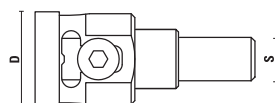

- Depth stopper made in metal alloy **with ball bearing inside for no-friction operations**
- Great chip evacuation thanks to two lateral openings.
- Easy adjustment of countersink and drilling depth.
- Complete with adjusting screw.



Item	D	S
Z003.900.N	32	9,5



Z051.214.R



Z052.055.N

ADJUSTABLE COUNTERSINK SET

ART. R156

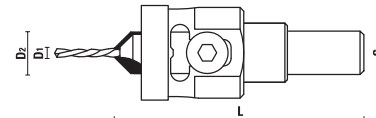

- Sold complete with HS drill bit (art R210)
- Depth stopper made in metal alloy **with ball bearing inside for no-friction operations**
- Great chip evacuation thanks to two lateral openings
- No risk of markings and scratches
- Easy adjustment of countersink and drilling depth
- Complete with adjusting screw



RH rotation	D1	D2	L	S
R156.030.R	3	10	73	9,5
R156.035.R	3,5	10	73	9,5
R156.040.R	4	10	73	9,5
R156.050.R	5	10	73	9,5



Z051.214.R



Z051.324.R



Z052.055.N



HW COUNTERSINKS 45° Z=2 WITH HEX SHANK

ART. R158

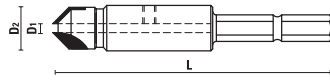

Quick change 1/4" (6,35mm) hex shank



RH rotation	D1	D2	L
R158.024.R	2,4	9,5	60
R158.028.R	2,8	9,5	60
R158.030.R	3	9,5	60
R158.032.R	3,2	9,5	60
R158.040.R	4	9,5	60
R158.050.R	5	12,7	70
R158.060.R	6	12,7	70



Z051.324.R



Z052.006.N

ADJUSTABLE DEPTH STOPPER

ART. Z003

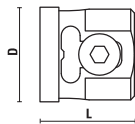

- With a special collar made in Delrin for low friction operation and easy depth adjustment
- Large side openings for chip clearance
- Z003.905.N for diam. from 2.4÷4
- Z003.906.N for diam. 5 and 6



Item	D	L
Z003.905.N	25	25
Z003.906.N	28	25

ADJUSTABLE COUNTERSINK SET

ART. R159

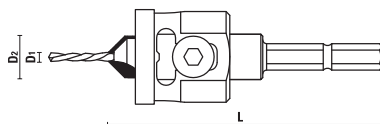

- Sold complete with HS drill bit (art R210)
- With a special collar made in Delrin for low friction operation and easy depth adjustment
- Quick change 1/4" (6,35mm) hex shank
- Large side openings for chip clearance



RH rotation	D1	D2	L
R159.024.R	2,4	9,5	60
R159.028.R	2,8	9,5	60
R159.030.R	3	9,5	60
R159.032.R	3,2	9,5	60
R159.040.R	4	9,5	60
R159.050.R	5	12,7	70
R159.060.R	6	12,7	70



Z051.214.R



Z051.324.R



Z052.055.N

HS PLUG CUTTERS Z=1

ART. R221

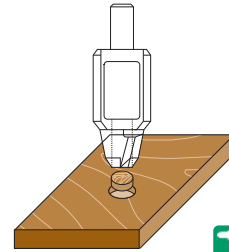
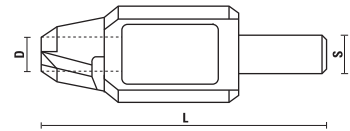

RH rotation	D	L	S	Z
R221.095.R	9,5	61	8	1
R221.100.R	10	61	8	1
R221.127.R	12,7	61	8	1

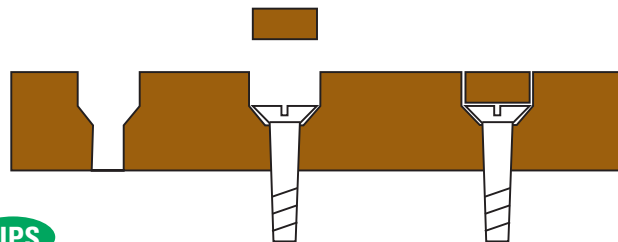

TIPS

After having used our adjustable countersink set (R156/R159), use our plug cutters (art R221) to obtain the plug to create a perfect and smooth surface.

HS SPIRAL BITS Z=2

ART. R210 - R215 - R216



Item	D1	D	L	S
R210.024.R		2,4	57	2,4
R210.028.R		2,8	61	2,8
R210.030.R		3	61	3
R210.032.R		3,2	65	3,2
R210.035.R		3,5	70	3,5
R210.040.R		4	75	4
R210.050.R		5	86	5
R210.060.R		6	93	6

R215.024.R	2,4	57	2,4
R215.032.R	3,2	70	3,2
R215.040.R	4	80	4
R215.050.R	5	89	5
R215.060.R	6	98	6

R216.040.R	2,8	4	75	4
R216.050.R	3,5	5	86	5

Art R210 Standard spiral drill bit for full thread screw

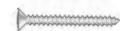

Art R215 Tapered drill bit for full thread screw and greater holding power

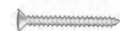

Art R216 Two steps drill bit for partial thread screw



HW/HS DOVETAIL BITS 9° - Z=1

ART. R151 - R251

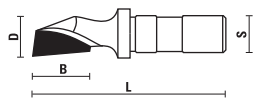

For OMEC machines

RH rotation	D	B	L	S	Z	Mat.
R151.140.R	14	18	60	12x30	1	HW
R251.140.R*	14	18	60	12x30	1	HS

* Selling out

VHW DOVETAIL BITS Z=2

ART. R152

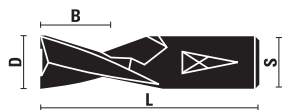

- For OMEC machines
- Solid carbide

RH rotation	D	B	L
R152.140.R	14	16	60

HW/HS DOVETAIL BITS Z=2

ART. R160 - R260

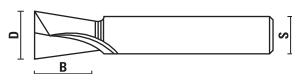

RH rotation	D	B	S	Mat.
R160.120.R	12	13	10x40	HW
R160.140.R	14	15	10x40	HW
R160.150.R	15	16	10x40	HW
R160.160.R	16	17	10x40	HW
R160.180.R	18	20	10x40	HW
R260.120.R	12	13	10x40	HS
R260.140.R	14	15	10x40	HS
R260.150.R	15	16	10x40	HS
R260.160.R	16	17	10x40	HS
R260.180.R	18	20	10x40	HS

- Add. charge for threaded shank
- Add. charge for inside threaded shank

SP SLOT MORTISING BITS WITH CHIPBREAKER Z=2

ART. S201- S202

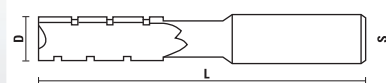

Chipbreaker execution



RH rotation	LH rotation	D	L	S	
S201.060.R	S201.060.L	6	105	13x50	
S201.061.R	S201.061.L	6	120	13x50	Long execution
S201.070.R	S201.070.L	7	110	13x50	
S201.080.R	S201.080.L	8	115	13x50	
S201.081.R	S201.081.L	8	130	13x50	Long execution
S201.090.R	S201.090.L	9	120	13x50	
S201.100.R	S201.100.L	10	125	13x50	
S201.101.R	S201.101.L	10	140	13x50	Long execution
S201.110.R	S201.110.L	11	130	13x50	
S201.120.R	S201.120.L	12	135	13x50	
S201.121.R	S201.121.L	12	150	13x50	Long execution
S201.130.R	S201.130.L	13	140	13x50	
S201.140.R	S201.140.L	14	145	13x50	
S201.141.R	S201.141.L	14	160	13x50	Long execution
S201.150.R	S201.150.L	15	150	13x50	
S201.160.R	S201.160.L	16	155	13x50	

S202.060.R	S202.060.L	6	105	16x50	
S202.061.R	S202.061.L	6	120	16x50	Long execution
S202.070.R	S202.070.L	7	110	16x50	
S202.080.R	S202.080.L	8	115	16x50	
S202.081.R	S202.081.L	8	130	16x50	Long execution
S202.090.R	S202.090.L	9	120	16x50	
S202.100.R	S202.100.L	10	125	16x50	
S202.101.R	S202.101.L	10	140	16x50	Long execution
S202.110.R	S202.110.L	11	130	16x50	
S202.120.R	S202.120.L	12	135	16x50	
S202.121.R	S202.121.L	12	150	16x50	Long execution
S202.130.R	S202.130.L	13	140	16x50	
S202.140.R	S202.140.L	14	145	16x50	
S202.141.R	S202.141.L	14	160	16x50	Long execution
S202.150.R	S202.150.L	15	150	16x50	
S202.160.R	S202.160.L	16	155	16x50	
S202.161.R	S202.161.L	16	170	16x50	Long execution
S202.180.R	S202.180.L	18	165	16x50	
S202.181.R	S202.181.L	18	180	16x50	Long execution
S202.200.R	S202.200.L	20	175	16x50	
S202.220.R	S202.220.L	22	180	16x50	
S202.240.R	S202.240.L	24	180	16x50	

X100.006.R 6 mortising bits set Ø 6 - 8 - 10 - 12 - 14 - 16 Rh rotation
X100.006.L 6 mortising bits set Ø 6 - 8 - 10 - 12 - 14 - 16 Lh rotation

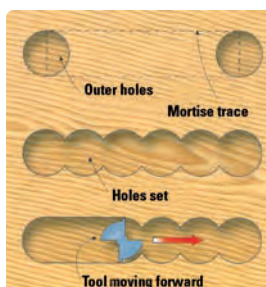

HL RECIPROCATING SLOT MORTISING BITS

ART. S210 - S211 - S212 - S213

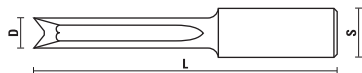

Item	D	L	S	Z
S210.060.N	6	100	16x50	2
S210.070.N	7	100	16x50	2
S210.080.N	8	100	16x50	2
S210.090.N	9	100	16x50	2
S210.100.N	10	110	16x50	2
S210.120.N	12	110	16x50	2
S210.140.N	14	110	16x50	2
S210.160.N	16	110	16x50	2
S211.060.N	6	100	13x50	4
S211.070.N	7	100	13x50	4
S211.080.N	8	100	13x50	4
S211.090.N	9	100	13x50	4
S211.100.N	10	110	13x50	4
S211.120.N	12	110	13x50	4
S211.140.N	14	110	13x50	4
S211.160.N	16	110	13x50	4
S212.060.N	6	60	12x30	2
S212.070.N	7	60	12x30	2
S212.080.N	8	60	12x30	2
S212.100.N	10	60	12x30	4
S212.120.N	12	60	12x30	4
S213.060.N	6	73	10x40	4
S213.070.N	7	73	10x40	4
S213.080.N	8	73	10x40	4
S213.100.N	10	73	10x40	4
S213.120.N	12	73	10x40	4

HL RECIPROCATING SLOT MORTISING BITS Z=3

ART. S214

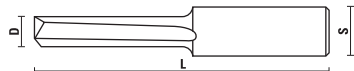

RH rotation	LH rotation	D	L	S	Z
S214.060.R	S214.060.L	6	110	16x50	3
S214.080.R	S214.080.L	8	110	16x50	3
S214.100.R	S214.100.L	10	110	16x50	3
S214.120.R	S214.120.L	12	110	16x50	3
S214.140.R	S214.140.L	14	115	16x50	3
S214.160.R	S214.160.L	16	115	16x50	3
S214.180.R	S214.180.L	18	115	16x50	3
S214.200.R	S214.200.L	20	115	16x50	3

HW RECIPROCATING SLOT MORTISING BITS

ART. S110 - S111

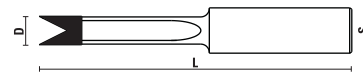

Item	D	L	S	Z
S110.060.N	6	100	16x50	2
S110.080.N	8	100	16x50	2
S110.100.N	10	110	16x50	2
S110.120.N	12	110	16x50	2
S110.140.N	14	110	16x50	2
S110.160.N	16	110	16x50	2
S111.060.N	6	100	13x50	2
S111.080.N	8	100	13x50	2
S111.100.N	10	110	13x50	2
S111.120.N	12	110	13x50	2
S111.140.N	14	110	13x50	2
S111.160.N	16	110	13x50	2

HW/SP GROOVING CUTTERS Z=2

ART. S120 - S220



For the lock housing

RH rotation	D	L	Mat.
S120.200.R	20	60	HM
S120.220.R	22	60	HM
S220.200.R	20	60	SP
S220.220.R	22	60	SP

HW/SP SLOT MORTISING CUTTERS Z=2

ART. S121 - S221



For cutting slots

RH rotation	D	L	Mat.
S121.120.R	12	100	HW
S121.140.R	14	100	HW
S221.120.R	12	100	SP
S221.140.R	14	100	SP

HW/SP BORING BITS Z=2

ART. S122 - S222

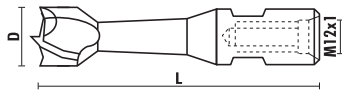

For boring

RH rotation	D	L	Mat.
S122.180.R	18	100	HW
S122.200.R	20	100	HW
S222.180.R	18	100	SP
S222.200.R	20	100	SP

HW/SP SLOT BORING BITS Z=2

ART. S123 - S223

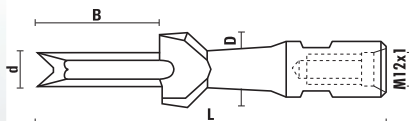

To produce slots and holes

RH rotation	d	D	B	L	Mat.
S123.110.R	11	19	62	155	HW
S123.120.R	12	19	62	155	HW
S223.110.R	11	19	62	155	SP
S223.120.R	12	19	62	155	SP

HS CUTTERS FOR COPYING LATHES

ART. S260

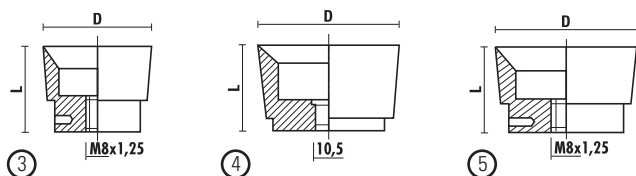
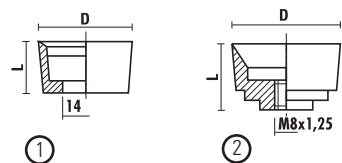

QUOTATION ON REQUEST

Item	Drawing	D	L
S260.320.N	1	32	15
S260.350.N	2	35	20
S260.360.N	3	36	26
S260.400.N	4	40	25
S260.450.N	5	45	26

HW HOLE SAWS

ART. S180

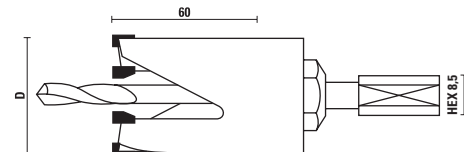

- For large boring depth, suitable for wood, chipboard, plastic materials, glass fibers ecc.
- Bore depth 60 mm
- Right hand rotation
- Single packed
- With HS centering drill included



Item	D	Z	RPM
S180.220.R	22	1	2.800
S180.250.R	25	1	2.800
S180.290.R	29	1	2.800
S180.320.R	32	2	2.300
S180.350.R	35	2	2.300
S180.380.R	38	2	2.300
S180.410.R	41	2	1.800
S180.440.R	44	2	1.800
S180.480.R	48	3	1.800
S180.510.R	51	3	1.800
S180.540.R	54	3	1.500
S180.600.R	60	3	1.500
S180.640.R	64	3	1.200
S180.680.R	68	3	1.200
S180.700.R	70	3	1.200
S180.760.R	76	4	1.000
S180.790.R	79	4	1.000
S180.890.R	89	4	1.000
S180.102.R	102	5	700
S180.999.R127	127	5	500

Spare parts

Arbor

S181.101.R	S=HEX8,5	For Ø22÷29	
S181.121.R	S=HEX8,5	For Ø32÷127	

HS centering drill

S182.063.R D=6,3 L=100

Application table

WOOD			PLASTIC			
Hard	Chipboard	Composites	Fiberglass	Acrylic	PVC	Rubber
XXX	XXX	XXX	XXX	XX	XX	XX

SOLID CARBIDE SPIRAL CUTTERS, TOOLHOLDERS AND ACCESSORIES FOR CNC ROUTER MACHINES

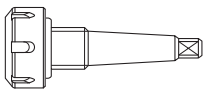

CONCENTRIC CHUCKS S-MK2
Page 7.11

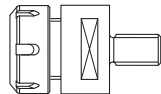

CONCENTRIC CHUCKS
Page 7.11

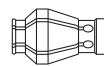

SPRING COLLETS
Page 7.11

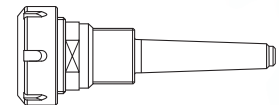

COLLET CHUCKS MORSE TAPER
Page 7.12

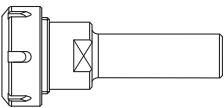

COLLET CHUCKS CYL SHANK Ø 20
Page 7.12

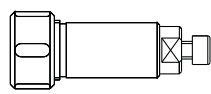

COLLET CHUCKS CYL SHANK Ø 25
Page 7.12

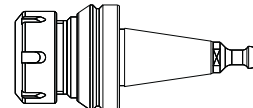

**COLLET CHUCKS ISO 30
TAPERED FLANGE**
Page 7.12

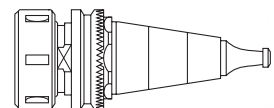

**COLLET CHUCKS ISO 30
SCM/MORBIDELLI**
Page 7.13

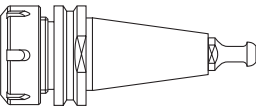

COLLET CHUCKS ISO 30
Page 7.13

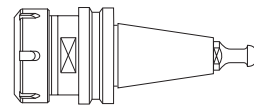

EXTENDED COLLET CHUCKS ISO 30
Pag. 7.14

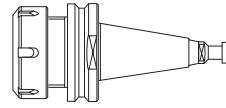

COLLET CHUCKS ISO 30 WITH FLANGE Ø 58
Pag. 7.15

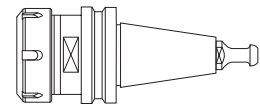

**COLLET CHUCKS ISO 30
WITH FLANGE Ø 46**
Pag. 7.15

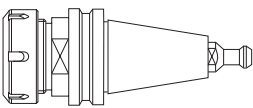

COLLET CHUCKS ISO 40
Page 7.15

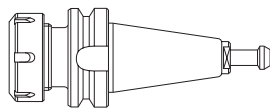

COLLET CHUCKS BT 30 - BT 35 - BT 40
Page 7.16

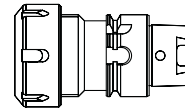

COLLET CHUCKS HSK-40A
Page 7.16

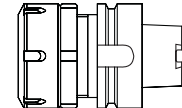

**COLLET CHUCKS HSK-63A WITH
RETURN RING NUT**
Page 7.16

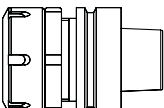

COLLET CHUCKS HSK-63F
Page 7.16

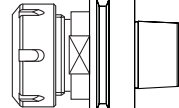

COLLET CHUCKS HSK-50F
Page 7.17

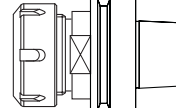

COLLET CHUCKS HSK-63F
Page 7.17

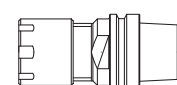

COLLET CHUCKS HSK-25E
Page 7.18

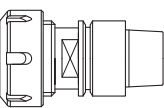

COLLET CHUCKS HSK-32E
Page 7.18

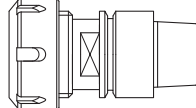

COLLET CHUCKS HSK-40E
Page 7.18

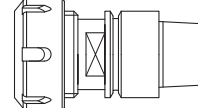

COLLET CHUCKS HSK-50E
Page 7.19

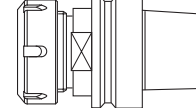

COLLET CHUCKS HSK-63E
Page 7.19



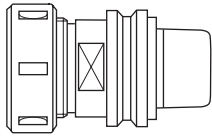

COLLET CHUCKS HSK-50E WITH FLANGE $\varnothing 40$
Pag. 7.19

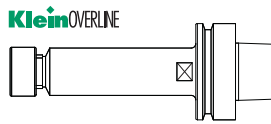

KleinOVERLINE
COLLET CHUCKS HSK-63F ER16 - G 2.5
BALANCING
Page 7.20

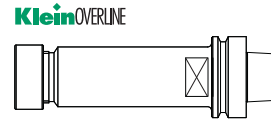

KleinOVERLINE
COLLET CHUCKS HSK-63F ER32 - G 2.5
BALANCING
Page 7.20

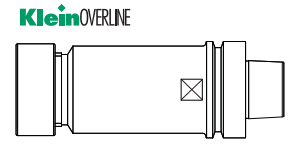

KleinOVERLINE
COLLET CHUCKS HSK-63F
DIN6388/EOC25 - G 2.5 BALANCING
Page 7.20

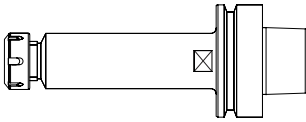

COLLET CHUCKS HSK-63F ER16 - G2.5
BALANCING
Pag. 7.21

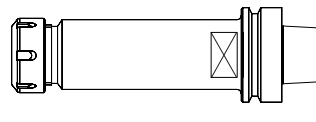

COLLET CHUCKS HSK-63F ER32 - G2.5
BALANCING
Pag. 7.21

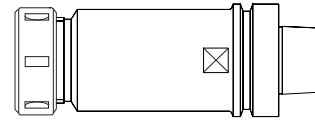

COLLET CHUCKS HSK-63F DIN6388/EOC25 -
G2.5 BALANCING
Pag. 7.21

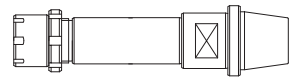

COLLET CHUCKS DIN 6499 (ER32)
FOR BACCI AND GREDA
Pag. 7.22

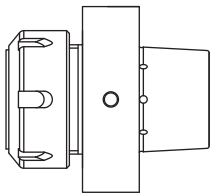

COLLET CHUCKS HSK-85 FOR WEINIG
Page 7.22

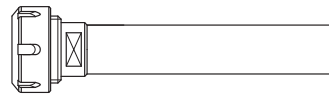

STRAIGHT SHANK TOOL EXTENSION
Page 7.22

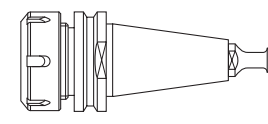

COLLET CHUCKS ISO 30 INOX
Page 7.23

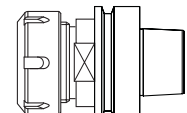

COLLET CHUCKS HSK-63F INOX
Page 7.23

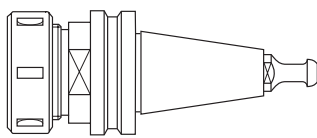

COLLET CHUCKS ISO 30 FOR MULTIAX
Page 7.24

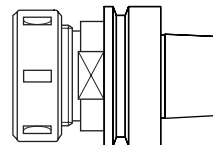

COLLET CHUCKS HSK-63F FOR MULTIAX
Page 7.24

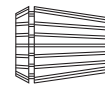

SPRING COLLETS ER 32 - DIN 6499
Page 7.26

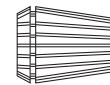

ULTRA PRECISION SPRING COLLETS
ER 32 - DIN 6499
Page 7.26



SPRING COLLET SET ER 32 - DIN 6499
Page 7.26

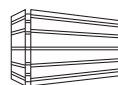

SPRING COLLETS ER 40 - DIN 6499
Page 7.27

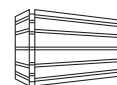

ULTRA PRECISION SPRING COLLETS
ER 40 - DIN 6499
Page 7.27



SPRING COLLET SET ER 40 - DIN 6499
Page 7.27

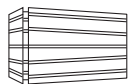

SPRING COLLETS EOC25 - DIN 6388 (462 E)
Page 7.27



SPRING COLLETS ER 25 - DIN 6499
Page 7.28



ULTRA PRECISION SPRING COLLETS
ER 25 - DIN 6499
Page 7.28



SPRING COLLET SET ER25 - DIN 6499
Page 7.28



SPRING COLLETS ER 20 - DIN 6499
Page 7.28



ULTRA PRECISION SPRING COLLETS
ER 20 - DIN 6499
Page 7.28



SPRING COLLETS ER 16 - DIN 6499
Page 7.29



ULTRA PRECISION SPRING COLLETS
ER 16 - DIN 6499
Page 7.29



SPRING COLLETS ER 11 - DIN 6499
Page 7.29

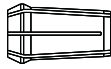

SPRING COLLETS EOC12 - DIN 6388 (407E)
Page 7.29

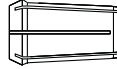

SPRING COLLETS EOC16 - DIN 6388 (415E)
Page 7.29

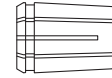

SPRING COLLETS 3° TAPER ANGLE FOR
MULTIAX
Page 7.30

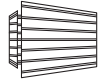

SPRING COLLETS ETS 32 - DIN 6499
Page 7.30

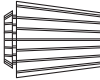

SPRING COLLETS ETS 40 - DIN 6499
Page 7.30



SPRING COLLET SET + WIPE OFF KIT
Page 7.30



SET IN WOODEN BOX
Page 7.31



SET IN PLASTIC BOX
Page 7.31



DUST & CHIP EXTRACTION NUT
Page 7.32



TORQUE WRENCHES FOR "MINI" NUTS
Page 7.33



TORQUE WRENCHES FOR
"STANDARD" NUTS
Page 7.33



TORQUE HOOK WRENCHES
Page 7.33



TORQUE WRENCHES FOR "NO-NOISE" NUTS
Page 7.33



KEYS
Page 7.34



COLLET NUTS
Page 7.34

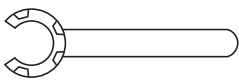

WRENCHES FOR COLLET NUT "MINI"
Page 7.34



DUST PLUG
Page 7.34



"NO-NOISE" COLLET NUTS
Page 7.34

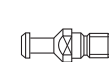

RETAINING PAWLS FOR
CONCENTRIC CHUCK
Page 7.35

HotBlock®

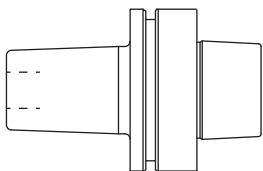

SHRINK FIT CHUCKS HSK-63F
Page 7.36

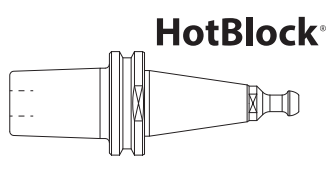

SHRINK FIT CHUCKS ISO 30
Page 7.36

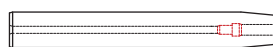

SHRINK FIT CHUCK EXTENSIONS L=150
Page 7.37



SHRINK FIT UNIT
Page 7.37



COOLING UNIT WITH AIR FLOW
Page 7.37

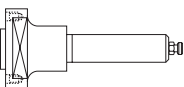

ADAPTERS FOR CIRCULAR SAWBLADES
Page 7.38

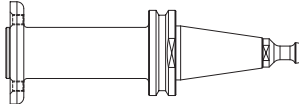

ISO 30 ADAPTERS FOR CIRCULAR
SAWBLADES
Page 7.38

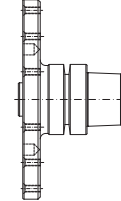

HSK-63E ADAPTERS FOR LARGE
DIAMETER SAWBLADES
Page 7.38

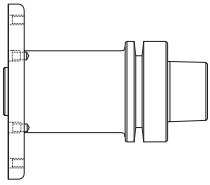

HSK-63 ADAPTERS FOR CIRCULAR SAWBLADES
Page 7.39



SECURITY FLANGE FOR SAW BLADES ADAPTERS
Page 7.39

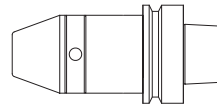

HSK-63F DRILL CHUCK FOR CNC
Page 7.40

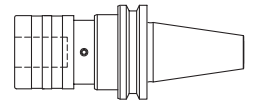

QUICK CHANGE ISO 30 TAPPING CHUCK
Page 7.40

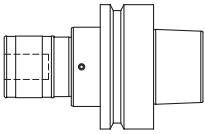

QUICK CHANGE HSK-63F TAPPING CHUCK
Page 7.40

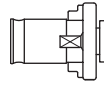

QUICK CHANGE BUSHES FOR TAPPING (DIN 371)
Page 7.41

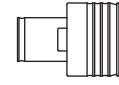

QUICK CHANGE BUSHES FOR TAPPING (DIN 371) WITH SAFETY CLUTCH
Page 7.41

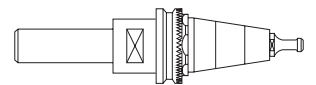

CUTTER ARBORS WITH ISO 30 TAPER
Page 7.42

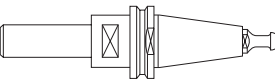

CUTTER ARBORS WITH ISO 30 - ISO 40 TAPER
Page 7.42

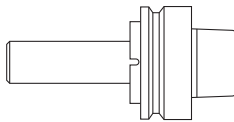

CUTTER ARBORS WITH HSK-63F TAPER
Page 7.43

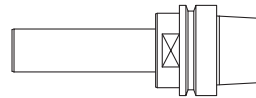

CUTTER ARBORS WITH HSK-63E TAPER
Page 7.44



LIFTING FLANGE FOR CUTTER ARBORS
Page 7.44

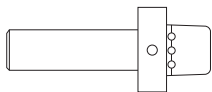

CUTTER ARBORS WITH HSK-85 TAPER
Page 7.45

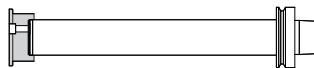

CUTTER ARBORS WITH HSK-85S TAPER
Page 7.45

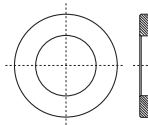

SPACERS 2-SIDES GRINDED
Page 7.46



PRECISION TEST BARS
Page 7.47

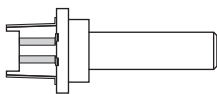

SPINDLE WIPERS
Page 7.48

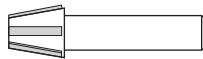

COLLET WIPERS
Page 7.48



BRUSHES FOR COLLET BORE
Page 7.48



WIPE OFF KIT FOR CNC
Page 7.48

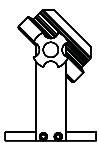

ADJUSTABLE DEMOUNT DEVICES
Page 7.49



DEMOUNT DEVICES FOR FLANGE $\varnothing 80 - \varnothing 85$
Page 7.49

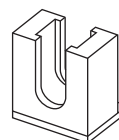

DEMOUNT DEVICES
Page 7.49



HW ROUTER BITS Z=2
Page 7.53



VHW ROUTER BITS Z=2
Page 7.53



SOLID CARBIDE SPIRAL CUTTERS, FINISH STYLE Z=1
Page 7.53



SOLID CARBIDE SPIRAL CUTTERS, FINISH STYLE Z=1
Page 7.53



SOLID CARBIDE SPIRAL CUTTERS, FINISH STYLE Z=2
Page 7.54

KleinDIA®



SOLID CARBIDE SPIRAL CUTTERS FINISH
STYLE Z=2, **KleinDIA** COATED
Page 7.54



SOLID CARBIDE SPIRAL CUTTERS,
FINISH STYLE Z=2
Page 7.54



SOLID CARBIDE SPIRAL CUTTERS, FINISH
STYLE Z=3
Page 7.55

KleinDIA®



SOLID CARBIDE SPIRAL CUTTERS
FINISH STYLE Z=3, **KleinDIA** COATED
Page 7.55



SOLID CARBIDE SPIRAL CUTTERS,
FINISH STYLE Z=3
Page 7.55



SOLID CARBIDE SPIRAL CUTTERS,
ROUGHING STYLE Z=3
Page 7.56



SOLID CARBIDE SPIRAL CUTTERS ROU-
GHING STYLE Z=3, **KleinDIA** COATED
Page 7.56



SOLID CARBIDE SPIRAL CUTTERS,
ROUGHING STYLE Z=3
Page 7.56



SOLID CARBIDE SPIRAL CUTTERS Z=3
RH ROTATION
Page 7.57



SOLID CARBIDE SPIRAL CUTTERS Z=3
LH ROTATION
Page 7.57



SOLID CARBIDE SPIRAL CUTTERS,
FINISH STYLE Z=1
Page 7.57



SOLID CARBIDE SPIRAL CUTTERS,
FINISH STYLE Z=2
Page 7.57

KleinDIA®



SOLID CARBIDE SPIRAL CUTTERS, FINISH
STYLE Z=2, **KleinDIA** COATED
Page 7.57



SOLID CARBIDE SPIRAL CUTTERS,
FINISH STYLE Z=2
Page 7.58



SOLID CARBIDE SPIRAL CUTTERS,
FINISH STYLE Z=3
Page 7.58



SOLID CARBIDE SPIRAL CUTTERS,
FINISH STYLE Z=3
Page 7.58



SOLID CARBIDE SPIRAL CUTTERS,
ROUGHING STYLE Z=3
Page 7.58



SOLID CARBIDE SPIRAL CUTTERS,
ROUGHING STYLE Z=3
Page 7.59



SOLID CARBIDE COMPRESSION CUTTERS
Z=1+1
Page 7.59

KleinDIA®



SOLID CARBIDE COMPRESSION
CUTTERS Z=1+1 **KleinDIA** COATED
Page 7.59



SOLID CARBIDE COMPRESSION
CUTTERS Z=1+1
Page 7.59



SOLID CARBIDE COMPRESSION
CUTTERS Z=2+2
Page 7.59



SOLID CARBIDE COMPRESSION
CUTTERS Z=2+2
Page 7.60

KleinDIA®



SOLID CARBIDE COMPRESSION
CUTTERS Z=2+2 **KleinDIA** COATED
Page 7.60



SOLID CARBIDE MORTISE COMPRESSION
Z=2+2
Page 7.60



SOLID CARBIDE MORTISE COMPRESSION
Z=2+2 **KleinDIA** COATED
Page 7.60



SOLID CARBIDE COMPRESSION
CUTTERS Z=3+3
Page 7.61



SOLID CARBIDE COMPRESSION
CUTTERS Z=3+3 **KleinDIA** COATED
Page 7.61



SOLID CARBIDE MORTISE COMPRESSION
Z=3+3
Page 7.61



SOLID CARBIDE MORTISE COMPRESSION
Z=3+3 **KleinDIA** COATED
Page 7.61



SOLID CARBIDE SPIRAL CUTTERS FOR
LOCK-CASE Z=2 - Z=3
Page 7.62



SOLID CARBIDE SPIRAL CUTTERS FOR
LOCK-CASE Z=3, **KleinDIA** COATED
Page 7.62



SOLID CARBIDE SPIRAL CUTTERS Z=3
FOR LOCKS
Page 7.62



SOLID CARBIDE SPIRAL
CUTTERS Z=2
Page 7.62



SOLID CARBIDE SPIRAL CUTTERS Z=2
Page 7.63



SOLID CARBIDE SPIRAL CUTTERS,
UPCUT FINISH STYLE Z=2
Page 7.63



SOLID CARBIDE SPIRAL CUTTERS,
DOWNCUT FINISH STYLE Z=2
Page 7.63



SOLID CARBIDE SPIRAL CUTTERS,
UPCUT FINISH STYLE Z=2
Page 7.63



SOLID CARBIDE SPIRAL CUTTERS,
FINISH STYLE Z=2
Page 7.63



SOLID CARBIDE COMPRESSION
CUTTERS Z=2+2 WITH DOUBLE BALL
BEARING
Page 7.64



HW FLUSH TRIM BITS WITH DOUBLE
BALL BEARINGS Z=2
Page 7.64



SOLID CARBIDE SPIRAL CUTTERS "LAMELLO"
KleinDIA COATED
Page 7.64



SOLID CARBIDE SPIRAL CUTTERS,
ROUGHING STYLE Z=2
Page 7.64



SOLID CARBIDE SPIRAL CUTTERS,
ROUGHING STYLE Z=2
Page 7.65



SOLID CARBIDE TAPERED BALL NOSE
SPIRAL BITS Z=3
Page 7.65



SOLID CARBIDE SPIRAL CUTTERS
RADIUS STYLE Z=2
Page 7.65



HS ROUTER BITS FOR "HUNDEGGER"
MACHINES
Page 7.65



SOLID CARBIDE SPIRAL ROUTER BITS
FINISH/ROUGHING STYLE
KleinDIA COATED
Page 7.66



SOLID CARBIDE SPIRAL ROUTER BITS
FINISH/ROUGHING STYLE **KleinDIA** COATED
Page 7.66



TOOL KIT FOR CNC ROUTERS
Page 7.67



TOOL KIT FOR CNC ROUTERS
Page 7.68

TOOL HOLDERS



THE HOLLOW TAPER SHANK IS PRODUCED ACCORDING TO DIN69893, ISO OR JIS STANDARDS WITH ACCURACY OF HSK-F SHANKS LOWER THAN A72

A DEDICATED POCKET INSIDE THE TAPER TO INSTALL BALLUFF/RFID CHIP

MAXIMUM ERROR OF CONCENTRICITY BETWEEN THE CONICAL PART AND THE TOOL'S SEAT OF 0.003 MM (RUNOUT: 0.0001")

TO ACHIEVE THE MAXIMUM LEVEL OF PRECISION, ALL OUR TOOL HOLDERS ARE MANUFACTURED BY HARD TURNING MACHINE AND THEN ALL THOROUGHLY PRECISION GROUNDED BOTH ON SHANK, OUTSIDE PART OF TAPER AND COLLET NUT THREADS

THE SPECIAL STEEL USED TO PRODUCE OUR TOOL HOLDERS HAVE A HARDNESS OF 58+2 HRC ON THE ROCKWELL HARDNESS SCALE WITH A DEPTH OF 0.8/1 MM

ALL OUR TOOL HOLDERS ARE LASER MARKED FOLLOWING EUROPEAN SAFETY REGULATIONS

THE BALL BEARING CLAMPING NUT IMPROVES THE CLAMPING PRECISION THANKS TO A HOMOGENEOUS CLAMPING FORCE. IT CAN BE USED BOTH FOR THE RIGHT-HAND AND LEFT-HAND ROTATION

QUALITY CONTROL

SISTEMI has always been known for the high quality of the products offered. Keywords of this success are the **attention to production materials** and the use of the most modern construction techniques together with more accurate controls and the continuous research of innovative products. Each toolholder is supplied packed in a carton box with internal sheet of guarantee inside.

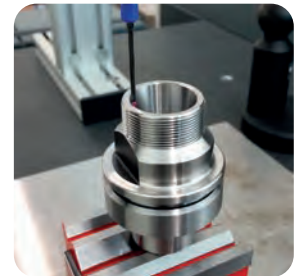

MAINTENANCE















A regular and **proper cleaning** of mechanical components is critical to avoid jamming during processing operations and the consequent risk of a poor finishing of the piece or even tool breakage. The worked pieces leave impurities and debris in the collets holes, in the seats of tool holders or electrospindles. These should be therefore cleaned daily using the **right wipers** (see items T137 and X137 at page 7.40)



USEFUL INFORMATION

- 1) The collect chuck may be used only on router machines and machining centers for processing wood and wood-based material with comparable cutting characteristics.
- 2) The instructions of the machine manufacturer regarding the suitability of the clamping device have to be observed.
- 3) The direction of rotation marked on the clamping device has to be observed and followed. The direction of rotation of the tool and the collet chuck has to be the same.
- 4) Do not exceed the maximum RPM "n max" marked on the collet chuck. The maximum RPM of the system is determined by the tool, if the RPM of the tool is lower than that of the chuck.



Type of toolholder		COLLET CHUCKS FOR SHANK CUTTERS							
		ER16	ER20	ER25	ER32	ER40	EOC12	EOC16	EOC25
	COLLET CHUCKS MORSE				Page 7.12				
	COLLET CHUCKS CYL				Page 7.12		Page 7.12		
	ISO30	Page 7.13	Page 7.13	Page 7.13	Page 7.12-7.13 7.14-7.15 7.23	Page 7.13-7.14 7.15-7.23			Page 7.14
	ISO40				Page 7.15	Page 7.15			
	BT30 - BT 35 - BT40				Page 7.16	Page 7.16			
	HSK-40A			Page 7.16	Page 7.16				
	HSK-63A					Page 7.16			
	HSK-50F	Page 7.17		Page 7.17	Page 7.17	Page 7.17			Page 7.17
	HSK-63F	Page 7.20 7.21		Page 7.17	Page 7.17-7.20 7.21-7.23	Page 7.16-7.17 7.23			Page 7.17-7.20 7.21-7.23
	HSK-25E	Page 7.18							
	HSK-32E		Page 7.18	Page 7.18					
	HSK-40E			Page 7.18	Page 7.18				
	HSK-50E			Page 7.19	Page 7.19				Page 7.19
	HSK-63E				Page 7.19	Page 7.19			
	HSK85					Page 7.22			

SHRINK FIT CHUCKS		DRILL CHUCK	SAW ADAPTORS	ARBORS						TAPPING CHUCK	DEMOUNT DEVICES
mm	inches			Ø1"	Ø30	Ø1-1/4"	Ø35	Ø40	Ø50		
			Page 7.38								
Page 7.36			Page 7.38		Page 7.42					Page 7.40	Page 7.49
											Page 7.49
											Page 7.49
											Page 7.49
											Page 7.49
											Page 7.49
Page 7.36	Page 7.36	Page 7.40	Page 7.39	Page 7.43	Page 7.43	Page 7.43	Page 7.43	Page 7.43		Page 7.40	Page 7.49
											Page 7.49
											Page 7.49
											Page 7.49
			Page 7.38-7.39		Page 7.44		Page 7.44	Page 7.44			Page 7.49
					Page 7.45		Page 7.45	Page 7.45	Page 7.45		Page 7.49

SAFETY NORMS

Table 1.1:
Calculation of the minimum clamping length (Safety regulation EN847-1).

On the tool shank the minimum clamping length is marked.
The shank has to be clamped as far as possible, but at least up to the marking of the minimum clamping length (K).
The free shank length (Lo) should be as short as possible, granting a higher rigidity and smaller risk of tool breakage.

Shank diameter S (mm)	Min. clamping length K (mm)
$S \leq 10$	$K \geq 20$
$10 < S < 25$	$K = S \times 2$
$S \geq 25$	$K = S \times 1,8$

WRONG ASSEMBLING

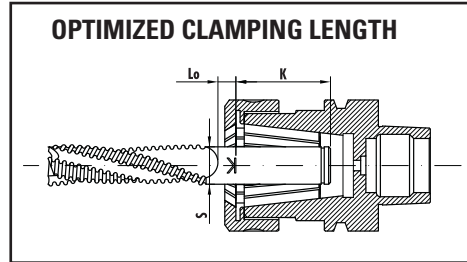
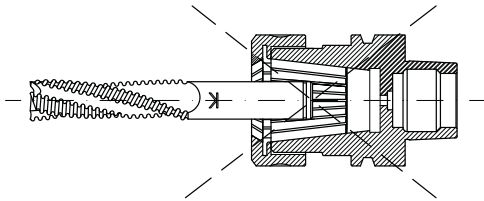

WRONG ASSEMBLING

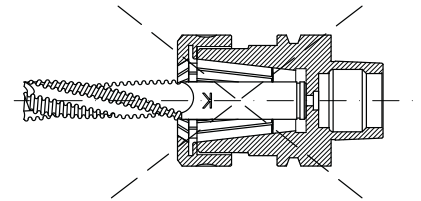

Safety norm for the calculation of the minimum clamping length

D = Tool diameter
B = Maximum safe length of the tool
S = Shank diameter

COLLET CHUCKS ISO30

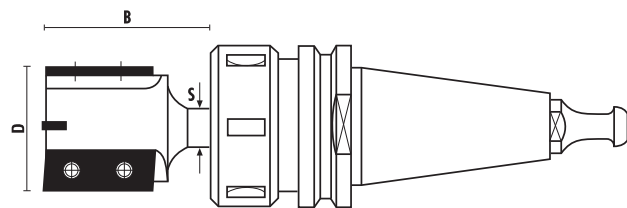

COLLET CHUCKS HSK63F

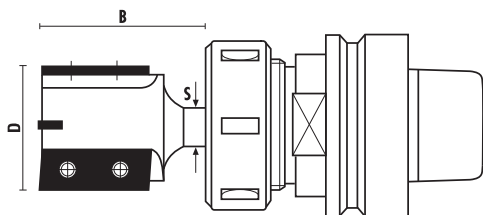

In order to avoid the risk of tool breakage during the job, make sure you answered the following questions:

- 1- Are you using the proper tool for the desired job?
- 2- Collets and tool holders are clean and the tool is inserted properly?
- 3- RPM and feed speed are correct?
- 4- Is the depth cut not too excessive for the material processed?
- 5- Are there any evident vibrations of the mechanical parts?
- 6- No right answer to your problem?
Stop running parts and check with your "Klein" distributor.

If you have to contact your distributor of technical support, please have ready the following information:

- a- Type of machine being used
- b- Type of material being cut
- c- Part number of tool, "Klein" item
- d- RPM/feed speed/depth of cut
- e- How long did the tool worked before it broke/damaged?
- f- Have you already done this operation in the past using the same tool?

Table 2.1

D (mm)	S (mm)								
	Ø 6	Ø 8	Ø 10	Ø 12	Ø 14	Ø 16	Ø 18	Ø 20	Ø 25
6	81								
8	66	94							
10	59	82	105						
12	53	73	94	115					
14	48	66	85	105	124				
16	44	61	78	96	114	133			
18	41	57	73	89	106	123	140		
20	38	53	68	84	99	115	132	148	
25		45	59	72	86	100	114	129	153
30		40	52	64	77	89	102	115	125
35			47	58	69	81	92	104	106
40			43	53	64	74	85	91	92
45				49	59	68	78	80	81
50				46	55	64	71	71	73
55					51	60	64	64	66
60					48	56	58	59	60
65					46	52	53	54	56
70						48	49	50	52
75						46	47	49	51
80							47	47	51
85								47	51
90								47	50
95								47	50
100								47	50
105									49
110									49

Table 2.2

D (mm)	S (mm)								
	Ø 6	Ø 8	Ø 10	Ø 12	Ø 14	Ø 16	Ø 18	Ø 20	Ø 25
6	81								
8	68	94							
10	59	82	105						
12	53	73	94	115					
14	48	66	85	105	124				
16	44	61	78	96	114	133			
18	41	57	73	89	106	123	140		
20	38	53	68	84	99	115	132	148	
25		45	59	72	86	100	114	129	165
30		40	52	64	77	89	102	115	147
35			47	58	69	81	92	104	133
40			43	53	64	74	85	95	123
45				49	59	68	78	88	114
50				46	55	64	73	83	106
55					51	60	69	78	100
60					48	56	65	73	94
65					46	53	61	69	90
70						51	59	66	85
75						48	55	63	82
80							53	60	78
85							51	58	75
90							49	56	72
95								56	70
100								52	68
105									65
110									64

Table 2.1:
Method for the calculation of the measure **B** for collet chucks ISO30

Table 2.2:
Method for the calculation of the measure **B** for collet chucks HSK63F

CONCENTRIC CHUCKS S=MK2

ART. T116

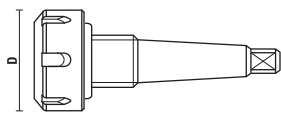

- Wrench art. Z052.301.N
- Spare parts see page 10.07
- Supplied with nut (without collet)

Item	D	Shank	Clamping nut
T116.100.R	40	C.M. 2/FIL M20	Z091.000.R
T116.100.L	40	C.M. 2/FIL M20	Z091.000.L

CONCENTRIC CHUCKS

ART. T116 - X116

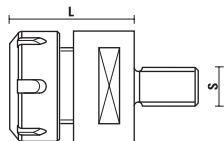

- Wrench art. Z052.301.N
- Spare parts see page 10.07
- With spare collets Art. T117
- To use on spindle moulder
- Supplied with nut (without collet)

Item X116
Set in wooden box

RH rotation	S	L	Clamping nut
T116.500.R	M16	42	Z091.000.R
T116.501.R	M14	42	Z091.000.R
T116.502.R	M18	42	Z091.000.R
T116.503.R	M20	42	Z091.000.R

X116.500.R	Set with chuck M16 + 3 spring collets \varnothing 6/8/12 (See itel T117)
X116.501.R	Set with chuck M14 + 3 spring collets \varnothing 6/8/12
X116.502.R	Set with chuck M18 + 3 spring collets \varnothing 6/8/12
X116.503.R	Set with chuck M20 + 3 spring collets \varnothing 6/8/12

SPRING COLLETS

ART. T117

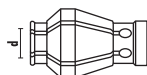

For Art. T116

Item	d
T117.060.N	\varnothing 6
T117.064.N	\varnothing 6,4
T117.080.N	\varnothing 8
T117.090.N	\varnothing 9
T117.095.N	\varnothing 9,5
T117.100.N	\varnothing 10
T117.110.N	\varnothing 11
T117.120.N	\varnothing 12
T117.127.N	\varnothing 12,7
T117.130.N	\varnothing 13
T117.140.N	\varnothing 14

COLLET CHUCKS MORSE TAPER

ART. T118

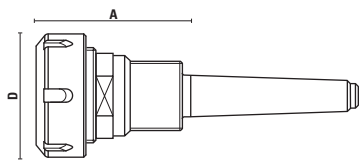

- Supplied with nut (without collet)
- Threaded nut and wrenches see page 7.33, spring collets see page 7.26
- Threaded nut DIN 6499
- The "A" measure will be determined with clamped tool shanks by using our spring collet DIN6499. The "A" measure may be subject to variations depending on the diameter of the clamped tools.

Item	Shank	A	D	Spring collets	Clamping nut	Rot.
T118.200.R	MK2 / FIL. M30	70	50	∅ 2÷20 (Art. T119/ER32)	Z091.001.R	RH
T118.200.L	MK2 / FIL. M30	70	50	∅ 2÷20 (Art. T119/ER32)	Z091.001.L	LH
T118.202.R	MK2 / FIL. M30	70	50	∅ 2÷20 (Art. T119/ER32)	Z091.101.R ball bearing nut	RH/LH
T118.300.R	MK3 / FIL. M30	70	50	∅ 2÷20 (Art. T119/ER32)	Z091.001.R	RH
T118.300.L	MK3 / FIL. M30	70	50	∅ 2÷20 (Art. T119/ER32)	Z091.001.L	LH
T118.302.R	MK3 / FIL. M30	70	50	∅ 2÷20 (Art. T119/ER32)	Z091.101.R ball bearing nut	RH/LH

COLLET CHUCKS CYL SHANK ∅ 20

ART. T118

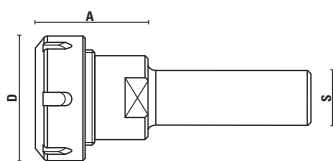

- Supplied with nut (without collet)
- Threaded nut and wrenches see page 7.33, spring collets see page 7.26
- Threaded nut DIN 6499
- The "A" measure will be determined with clamped tool shanks by using our spring collet DIN6499. The "A" measure may be subject to variations depending on the diameter of the clamped tools.

Item	S	A	D	Spring collets	Clamping nut	Rot.
T118.400.R	20	51	50	∅ 2÷20 (Art. T119/ER32)	Z091.001.R	RH
T118.402.R	20	51	50	∅ 2÷20 (Art. T119/ER32)	Z091.101.R ball bearing nut	RH/LH

COLLET CHUCKS CYL SHANK ∅ 25

ART. T118

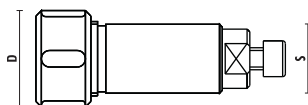

- Supplied with nut (without collet)
- Threaded nut and wrenches see page 7.31, spring collets see page 7.29
- Threaded nut DIN 6388/EOC12

For: **Weeke, BHX** machines

Item	S	D	Spring collets	Clamping nut	Rot.
T118.580.R	25	35	∅ 1÷12,7 (Art. T136/EOC12)	Z091.205.R	RH

COLLET CHUCKS ISO 30 TAPERED FLANGE

ART. T118

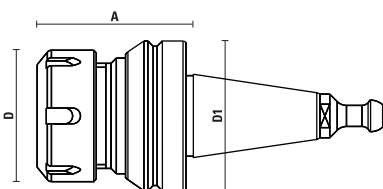

RPM
24.000

T139.157.N

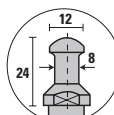

- Supplied with nut (without collet) and retaining pawl
- Threaded nut and wrenches see page 7.33, spring collets see page 7.26
- Threaded nut DIN 6499
- The "A" measure will be determined with clamped tool shanks by using our spring collet DIN6499. The "A" measure may be subject to variations depending on the diameter of the clamped tools.

For: **Thermwood**

Item	A	D	D1	Spring collets	Clamping nut	Rot.
T118.680.R	58	50	57	∅ 2÷20 (Art. T119/ER32)	Z091.001.R	RH

COLLET CHUCKS ISO 30 SCM/MORBIDELLI

ART. T118

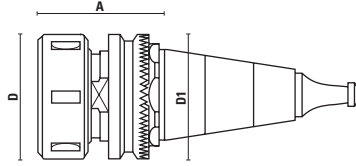

- Supplied with nut (without collet) and retaining pawl
- Threaded nut and wrenches see page 7.33, spring collets see page 7.26, 7.27
- Threaded nut DIN 6499
- Threaded nut DIN 6388/EOC25
- The "A" measure will be determined with clamped tool shanks by using our spring collet DIN6499 - DIN 6388/EOC25. The "A" measure may be subject to variations depending on the diameter of the clamped tools

RPM
24.000

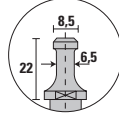

Item T118.790.R for:
Morbidei, SCM

With anti-adherent surface treatment "Impregon"

Item	Taper	A	D	D1	Spring collets	Clamping nut	Rot.
T118.700.R	ISO 30	55	50	49	∅ 2÷20 (Art. T119/ER32)	Z091.001.R	RH
T118.702.R	ISO 30	55	50	49	∅ 2÷20 (Art. T119/ER32)	Z091.101.R ball bearing nut	RH/LH
T118.701.R	ISO 30	71	60	49	∅ 2÷25 (Art. T124/EOC25)	Z091.203.R ball bearing nut	RH/LH
T118.711.R	ISO 30	71	60	49	∅ 2÷25 (Art. T124/EOC25)	Z091.202.R	RH
T118.711.L selling out	ISO 30	71	60	49	∅ 2÷25 (Art. T124/EOC25)	Z091.202.L	LH

COLLET CHUCKS ISO 30

ART. T118

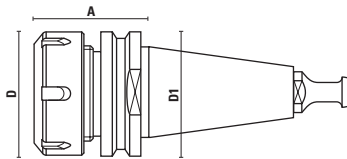

- Supplied with nut (without collet) and retaining pawl
- Threaded nut and wrenches see page 7.33, spring collets see page 7.26, 7.27, 7.28, 7.29
- Threaded nut DIN 6499
- The "A" measure will be determined with clamped tool shanks by using our spring collet DIN6499. The "A" measure may be subject to variations depending on the diameter of the clamped tools.

RPM
24.000

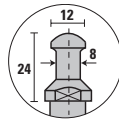

Item T118.891.R for: **Biesse** (after 09/09/92), **HSD spindle**, **Masterwood - Bulleri, Vitap, Hiteco**

Item	Taper	A	D	D1	Spring collets	Clamping nut	Rot.
T118.796.R	ISO 30	50	32	50	∅ 2÷10 (Art. T127/ER16)	Z091.105.R	RH
T118.797.R	ISO 30	50	35	50	∅ 2÷12 (Art. T126/ER20)	Z091.104.R	RH
T118.798.R	ISO 30	50	42	50	∅ 1÷16 (Art. T125/ER25)	Z091.103.R	RH
T118.800.R	ISO 30	50	50	50	∅ 2÷20 (Art. T119/ER32)	Z091.001.R	RH
T118.800.L	ISO 30	50	50	50	∅ 2÷20 (Art. T119/ER32)	Z091.001.L	LH
T118.802.R	ISO 30	50	50	50	∅ 2÷20 (Art. T119/ER32)	Z091.101.R ball bearing nut	RH/LH
T118.830.R	ISO 30	60	63	50	∅ 2÷30 (Art. T123/ER40)	Z091.002.R	RH
T118.830.L	ISO 30	60	63	50	∅ 2÷30 (Art. T123/ER40)	Z091.002.L	LH
T118.832.R	ISO 30	60	63	50	∅ 2÷30 (Art. T123/ER40)	Z091.102.R ball bearing nut	RH/LH

EXTENDED COLLET CHUCKS ISO 30

ART. T118

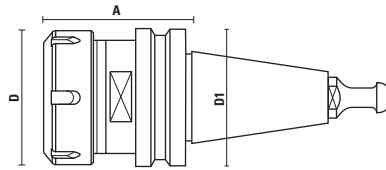

- Supplied with nut (without collet) and retaining pawl
- Threaded nut and wrenches see page 7.33, spring collets see page 7.26, 7.27
- Threaded nut DIN 6499
- The "A" measure will be determined with clamped tool shanks by using our spring collet DIN6499. The "A" measure may be subject to variations depending on the diameter of the clamped tools.

RPM
24.000

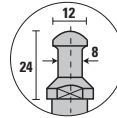

Item T118.891.R for: **Biesse** (after 09/09/92), **HSD spindle**, **Masterwood - Bulleri, Vitap, Hiteco**

Item	Taper	A	D	D1	Spring collets	Clamping nut	Rot.
T118.804.R	ISO 30	68	50	50	∅ 2÷20 (Art. T119/ER32)	Z091.001.R	RH
T118.804.L	ISO 30	68	50	50	∅ 2÷20 (Art. T119/ER32)	Z091.001.L	LH
T118.806.R	ISO 30	68	50	50	∅ 2÷20 (Art. T119/ER32)	Z091.101.R ball bearing nut	RH/LH
T118.834.R	ISO 30	68	63	50	∅ 2÷30 (Art. T123/ER40)	Z091.002.R	RH
T118.834.L	ISO 30	68	63	50	∅ 2÷30 (Art. T123/ER40)	Z091.002.L	LH
T118.836.R	ISO 30	68	63	50	∅ 2÷30 (Art. T123/ER40)	Z091.102.R ball bearing nut	RH/LH
T118.838.R	ISO 30	68	60	50	∅ 2÷25 (Art. T124/EOC25)	Z091.202.R	RH
T118.839.R	ISO 30	68	60	50	∅ 2÷25 (Art. T124/EOC25)	Z091.203.R ball bearing nut	RH/LH

RPM
24.000

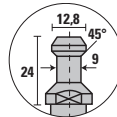

Item T118.792.R for: **Alberti, Vitap, Masterwood** (motor G. Colombo)

Item	Taper	A	D	D1	Spring collets	Clamping nut	Rot.
T118.810.R	ISO 30	68	50	50	∅ 2÷20 (Art. T119/ER32)	Z091.001.R	RH
T118.810.L	ISO 30	68	50	50	∅ 2÷20 (Art. T119/ER32)	Z091.001.L	LH
T118.812.R	ISO 30	68	50	50	∅ 2÷20 (Art. T119/ER32)	Z091.101.R ball bearing nut	RH/LH
T118.814.R	ISO 30	68	63	50	∅ 2÷30 (Art. T123/ER40)	Z091.002.R	RH
T118.814.L	ISO 30	68	63	50	∅ 2÷30 (Art. T123/ER40)	Z091.002.L	LH
T118.816.R	ISO 30	68	63	50	∅ 2÷30 (Art. T123/ER40)	Z091.102.R ball bearing nut	RH/LH

RPM
24.000

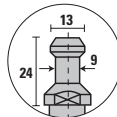

Item T118.791.R for: **Anderson, Busellato, Weeke, Ima, Bulleri, Maka, Cosmec, Reichenbacher**

Item	Taper	A	D	D1	Spring collets	Clamping nut	Rot.
T118.820.R	ISO 30	68	50	50	∅ 2÷20 (Art. T119/ER32)	Z091.001.R	RH
T118.820.L	ISO 30	68	50	50	∅ 2÷20 (Art. T119/ER32)	Z091.001.L	LH
T118.822.R	ISO 30	68	50	50	∅ 2÷20 (Art. T119/ER32)	Z091.101.R ball bearing nut	RH/LH
T118.824.R	ISO 30	68	63	50	∅ 2÷30 (Art. T123/ER40)	Z091.002.R	RH
T118.824.L	ISO 30	68	63	50	∅ 2÷30 (Art. T123/ER40)	Z091.002.L	LH
T118.826.R	ISO 30	68	63	50	∅ 2÷30 (Art. T123/ER40)	Z091.102.R ball bearing nut	RH/LH
T118.828.R	ISO 30	68	60	50	∅ 2÷25 (Art. T124/EOC25)	Z091.202.R	RH
T118.829.R	ISO 30	68	60	50	∅ 2÷25 (Art. T124/EOC25)	Z091.203.R ball bearing nut	RH/LH

COLLET CHUCKS ISO 30 WITH FLANGE Ø 58

ART. T118

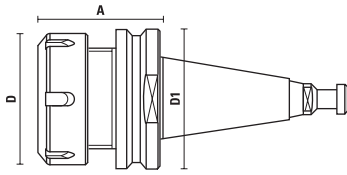

RPM
24.000

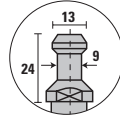

- Supplied with nut (without collet) and retaining pawl
- Threaded nut and wrenches see page 7.33, spring collets see page 7.26, 7.27
- Threaded nut DIN 6499
- The "A" measure will be determined with clamped tool shanks by using our spring collet DIN6499. The "A" measure may be subject to variations depending on the diameter of the clamped tools.

Item T118.791.R for:
electrospindles **Anderson, Elte**

Item	Taper	A	D	D1	Spring collets	Clamping nut	Rot.
T118.845.R	ISO 30	50	50	58	Ø 2÷20 (Art. T119/ER32)	Z091.001.R	RH
T118.846.R	ISO 30	50	50	58	Ø 2÷20 (Art. T119/ER32)	Z091.101.R ball bearing nut	RH/LH
T118.847.R	ISO 30	56	63	58	Ø 2÷30 (Art. T123/ER40)	Z091.002.R	RH
T118.848.R	ISO 30	56	63	58	Ø 2÷30 (Art. T123/ER40)	Z091.102.R ball bearing nut	RH/LH

RPM
24.000

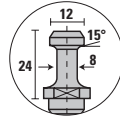

Item T118.793.R for:
Esseteam (solid flange)

Item	Taper	A	D	D1	Spring collets	Clamping nut	Rot.
T118.861.R	ISO 30	50	50	58	Ø 2÷20 (Art. T119/ER32)	Z091.001.R	RH
T118.862.R	ISO 30	50	50	58	Ø 2÷20 (Art. T119/ER32)	Z091.101.R ball bearing nut	RH/LH
T118.864.R	ISO 30	56	63	58	Ø 2÷30 (Art. T123/ER40)	Z091.002.R	RH
T118.866.R	ISO 30	56	63	58	Ø 2÷30 (Art. T123/ER40)	Z091.102.R ball bearing nut	RH/LH

COLLET CHUCKS ISO 30 WITH FLANGE Ø 46

ART. T118

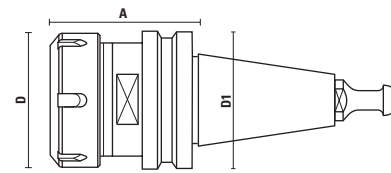

RPM
24.000

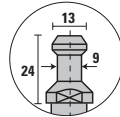

- Supplied with nut (without collet) and retaining pawl
- Threaded nut and wrenches see page 7.33, spring collets see page 7.26, 7.27, 7.30
- Threaded nut DIN 6499
- The "A" measure will be determined with clamped tool shanks by using our spring collet DIN6499. The "A" measure may be subject to variations depending on the diameter of the clamped tools.

Item T118.794.R for:
CMS (flange Ø 46)

Item	Taper	A	D	D1	Spring collets	Clamping nut	Rot.
T118.880.R	ISO 30	52	50	46	Ø 2÷20 (Art. T134/ETS32)	Z091.301.R	RH
T118.881.R	ISO 30	52	50	46	Ø 2÷20 (Art. T119/ER32)	Z091.001.R	RH
T118.882.R	ISO 30	57	63	46	Ø 2÷25 (Art. T135/ETS40)	Z091.302.R	RH
T118.883.R	ISO 30	57	63	46	Ø 2÷25 (Art. T123/ER40)	Z091.002.R	RH

COLLET CHUCKS ISO 40

ART. T118

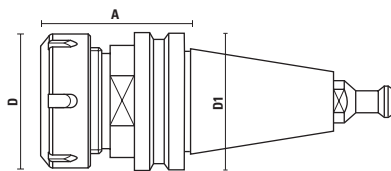

RPM
24.000

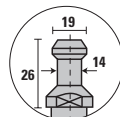

- Supplied with nut (without collet) and retaining pawl
- Threaded nut and wrenches see page 7.33, spring collets see page 7.26, 7.27
- Threaded nut DIN 6499
- The "A" measure will be determined with clamped tool shanks by using our spring collet DIN6499. The "A" measure may be subject to variations depending on the diameter of the clamped tools.

Item T118.893.R for:
IMA, Weeke, Maka, Reichenbacher, Stegerr

Item	Taper	A	D	D1	Spring collets	Clamping nut	Rot.
T118.850.R	ISO 40	73	50	63,5	Ø 2÷20 (Art. T119/ER32)	Z091.001.R	RH
T118.852.R	ISO 40	73	50	63,5	Ø 2÷20 (Art. T119/ER32)	Z091.101.R ball bearing nut	RH/LH
T118.870.R	ISO 40	73	63	63,5	Ø 2÷30 (Art. T123/ER40)	Z091.002.R	RH
T118.872.R	ISO 40	73	63	63,5	Ø 2÷30 (Art. T123/ER40)	Z091.102.R ball bearing nut	RH/LH

COLLET CHUCKS BT 30 - BT 35 - BT 40

ART. T118

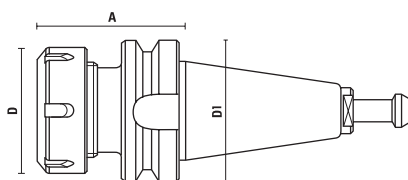

- Supplied with nut (without collet) and retaining pawl
- Threaded nut and wrenches see page 7.33, spring collets see page 7.26, 7.27
- Threaded nut DIN 6499
- The "A" measure will be determined with clamped tool shanks by using our spring collet DIN6499. The "A" measure may be subject to variations depending on the diameter of the clamped tools

RPM
24.000

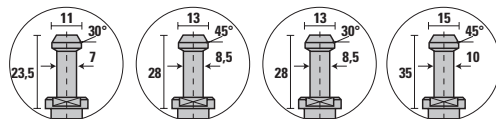

- Item T118.895.R for: BT 30 **Shoda**
- Item T118.896.R for: BT 35 **Heian (1)**
- Item T118.896.R030 for: BT 35 **Heian (2)**
- Item T118.897.R for: BT 40 **Shoda**

Item	Taper	A	D	D1	Spring collets	Clamping nut	Rot.
T118.910.R	BT 30	60	50	46	Ø 2÷20 (Art. T119/ER32)	Z091.101.R ball bearing nut	RH/LH
T118.912.R	BT 30	70	63	46	Ø 2÷30 (Art. T123/ER40)	Z091.102.R ball bearing nut	RH/LH
T118.920.R	BT 35 (1)	69	50	53	Ø 2÷20 (Art. T119/ER32)	Z091.101.R ball bearing nut	RH/LH
T118.921.R	BT 35 (2)	69	50	53	Ø 2÷20 (Art. T119/ER32)	Z091.101.R ball bearing nut	RH/LH
T118.922.R	BT 35 (1)	60	63	53	Ø 2÷30 (Art. T123/ER40)	Z091.102.R ball bearing nut	RH/LH
T118.923.R	BT 35 (2)	60	63	53	Ø 2÷30 (Art. T123/ER40)	Z091.102.R ball bearing nut	RH/LH
T118.930.R	BT 40	65	50	63	Ø 2÷20 (Art. T119/ER32)	Z091.101.R ball bearing nut	RH/LH

COLLET CHUCKS HSK-40A

ART. T118

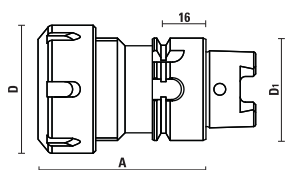

- The hollow taper shank is produced according to DIN69893

- Supplied with nut (without collet)

- Threaded nut and wrenches see page 7.33, spring collets see page 7.26, 7.28

- Threaded nut DIN 6499

- The "A" measure will be determined with clamped tool shanks by using our spring collet DIN6499. The "A" measure may be subject to variations depending on the diameter of the clamped tools

RPM
24.000



BALLUFF
POCKET

- For "Centaurus"

Item	Taper	A	D	D1	Spring collets	Clamping nut	Rot.
T118.950.R	HSK-40A	65	50	40	Ø 2÷20 (Art. T119/ER32)	Z091.001.R	RH
T118.951.R NEW	HSK-40A	65	42	40	Ø 1÷16 (Art. T125/ER25)	Z091.103.R	RH

COLLET CHUCKS HSK-63A WITH RETURN RING NUT

ART. T118

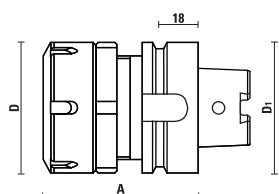

- The hollow taper shank is produced according to DIN69893

- Supplied with nut (without collet) and return ring nut

- Threaded nut and wrenches see page 7.33, spring collets see page 7.27

- Threaded nut DIN 6499

- The "A" measure will be determined with clamped tool shanks by using our spring collet DIN6499. The "A" measure may be subject to variations depending on the diameter of the clamped tools

RPM
24.000



BALLUFF
POCKET

- For "Essetre"

Item	Taper	A	D	D1	Spring collets	Clamping nut	Return ring nut	Rot.
T118.956.R	HSK-63A	71	63	63	Ø 2÷30 (Art. T123/ER40)	Z091.002.R	Z091.902.R	RH

COLLET CHUCKS HSK-63F

ART. T118

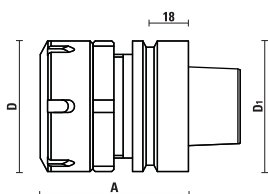

- The hollow taper shank is produced according to DIN69893

- Supplied with nut (without collet) and return ring nut

- Threaded nut and wrenches see page 7.33, spring collets see page 7.27

- Threaded nut DIN 6499

- The "A" measure will be determined with clamped tool shanks by using our spring collet DIN6499. The "A" measure may be subject to variations depending on the diameter of the clamped tools

RPM
24.000



BALLUFF
POCKET

- For "Essetre"

Item	Taper	A	D	D1	Spring collets	Clamping nut	Return ring nut	Rot.
T118.953.R	HSK-63F	71	63	63	Ø 2÷30 (Art. T123/ER40)	Z091.102.R	Z091.902.R	RH

- For "Uniteam"

Item	Taper	A	D	D1	Spring collets	Clamping nut	Return ring nut	Rot.
T118.959.R	HSK-63F	79	63	63	Ø 2÷30 (Art. T123/ER40)	Z091.002.R	Z091.902.R	RH

COLLET CHUCKS HSK-50F

ART. T118

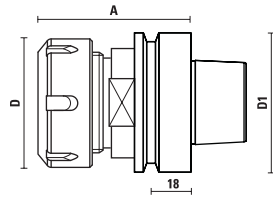

- The hollow taper shank is produced according to DIN69893
- Supplied with nut (without collet)
- Threaded nut and wrenches see page 7.33, spring collets see page 7.27, 7.28, 7.29
- Threaded nut DIN 6499
- Threaded nut DIN 6388 (EOC25)
- The "A" measure will be determined with clamped tool shanks by using our spring collet DIN6499 - DIN 6388/EOC25. The "A" measure may be subject to variations depending on the diameter of the clamped tools

RPM
24.000

T139.150.N

BALLUFF
POCKET

Item	Taper	A	D	D1	Spring collets	Clamping nut	Rot.
T118.960.R NEW	HSK-50F	70	32	50	∅ 1÷10 (Art. T127/ER16)	Z091.105.R	RH
T118.962.R	HSK-50F	60	42	50	∅ 1÷16 (Art. T125/ER25)	Z091.103.R	RH
T118.966.R	HSK-50F	73	50	50	∅ 2÷20 (Art. T119/ER32)	Z091.001.R	RH
T118.968.R	HSK-50F	76	50	50	∅ 2÷20 (Art. T119/ER32)	Z091.101.R ball bearing nut	RH/LH
T118.970.R	HSK-50F	76	63	50	∅ 2÷30 (Art. T123/ER40)	Z091.002.R	RH
T118.972.R	HSK-50F	78	63	50	∅ 2÷30 (Art. T123/ER40)	Z091.102.R ball bearing nut	RH/LH
T118.974.R	HSK-50 F	78	60	50	∅ 2÷26 (Art. T124/EOC25)	Z091.203.R	RH

COLLET CHUCKS HSK-63F

ART. T118

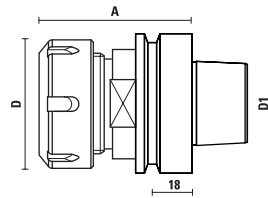

- The hollow taper shank is produced according to DIN69893
- Supplied with nut (without collet)
- Threaded nut and wrenches see page 7.33, spring collets see page 7.27, 7.28, 7.29
- Threaded nut DIN 6499
- Threaded nut DIN 6388 (EOC25)
- The "A" measure will be determined with clamped tool shanks by using our spring collet DIN6499 - DIN 6388/EOC25. The "A" measure may be subject to variations depending on the diameter of the clamped tools

RPM
24.000

T139.163.N

BALLUFF
POCKET

Item	Taper	A	D	D1	Spring collets	Clamping nut	Rot.
T118.975.R	HSK-63 F	70	42	63	∅ 1÷16 (Art. T125/ER25)	Z091.103.R	RH
T118.976.R	HSK-63 F	75	50	63	∅ 2÷20 (Art. T119/ER32)	Z091.001.R	RH
T118.976.L	HSK-63 F	75	50	63	∅ 2÷20 (Art. T119/ER32)	Z091.001.L	LH
T118.978.R	HSK-63 F	76	50	63	∅ 2÷20 (Art. T119/ER32)	Z091.101.R ball bearing nut	RH/LH
T118.980.R	HSK-63 F	75	63	63	∅ 2÷30 (Art. T123/ER40)	Z091.002.R	RH
T118.980.L	HSK-63 F	75	63	63	∅ 2÷30 (Art. T123/ER40)	Z091.002.L	LH
T118.982.R	HSK-63 F	78	63	63	∅ 2÷30 (Art. T123/ER40)	Z091.102.R ball bearing nut	RH/LH
T118.983.R	HSK-63 F	78	60	63	∅ 2÷26 (Art. T124/EOC25)	Z091.202.R	RH
T118.984.R	HSK-63 F	78	60	63	∅ 2÷26 (Art. T124/EOC25)	Z091.203.R ball bearing nut	RH/LH
T118.994.R	HSK-63 F	115	60	63	∅ 2÷26 (Art. T124/EOC25)	Z091.203.R ball bearing nut	RH/LH

COLLET CHUCKS HSK-25E

ART. T118

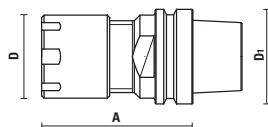

- The hollow taper shank is produced according to DIN69893
- Supplied with nut (without collet)
- Threaded nut and wrenches see page 7.33, spring collets see page 7.29
- Threaded nut DIN 6499
- Balanced to 40.000 RPM at G2,5 for "Multicam" machines
- The "A" measure will be determined with clamped tool shanks by using our spring collet DIN6499. The "A" measure may be subject to variations depending on the diameter of the clamped tools

RPM
40.000

BALLUFF
POCKET

Item	Taper	A	D	D1	Spring collets	Clamping nut	Rot.
T118.990.R	HSK-25E	40	22	25	∅ 1÷10 (Art. T127/ER16)	Z091.405.R Mini	RH

COLLET CHUCKS HSK-32E

ART. T118

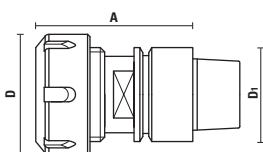

- The hollow taper shank is produced according to DIN69893
- Supplied with nut (without collet)
- Threaded nut and wrenches see page 7.33, spring collets see page 7.28
- Threaded nut DIN 6499
- Balanced to 40.000 RPM at G2,5 for "Multicam" machines
- The "A" measure will be determined with clamped tool shanks by using our spring collet DIN6499. The "A" measure may be subject to variations depending on the diameter of the clamped tools

RPM
40.000

T139.132.N

BALLUFF
POCKET

Item	Taper	A	D	D1	Spring collets	Clamping nut	Rot.
T118.991.R	HSK-32E	60	35	32	∅ 2÷13 (Art. T126/ER20)	Z091.104.R	RH
T118.992.R	HSK-32E	60	42	32	∅ 1÷16 (Art. T125/ER25)	Z091.103.R	RH

COLLET CHUCKS HSK-40E

ART. T118

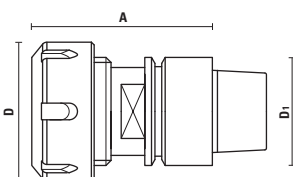

- The hollow taper shank is produced according to DIN69893
- Supplied with nut (without collet)
- Threaded nut and wrenches see page 7.33, spring collets see page 7.26, 7.28
- Balanced to 34.000 RPM at G2,5
- The "A" measure will be determined with clamped tool shanks by using our spring collet DIN 6388 (EOC25). The "A" measure may be subject to variations depending on the diameter of the clamped tools

RPM
34.000

T139.140.N

BALLUFF
POCKET

For "SD" machine

Item	Taper	A	D	D1	Spring collets	Clamping nut	Rot.
T118.993.R	HSK-40E	70	35	40	∅ 1÷16 (Art. T125/ER25)	Z091.403.R Mini	RH
T118.995.R	HSK-40E	70	50	40	∅ 2÷20 (Art. T119/ER32)	Z091.001.R	RH

COLLET CHUCKS HSK-50E

ART. T118

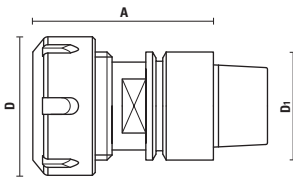

RPM
24.000

T139.150.N

BALLUFF
POCKET

- The hollow taper shank is produced according to DIN69893
- Supplied with nut (without collet)
- Threaded nut and wrenches see page 7.33, spring collets see page 7.26, 7.28
- The "A" measure will be determined with clamped tool shanks by using our spring collet DIN 6388 (EOC25). The "A" measure may be subject to variations depending on the diameter of the clamped tools

Item	Taper	A	D	D1	Spring collets	Clamping nut	Rot.
T118.997.R	HSK-50E	80	42	50	∅ 1÷16 (Art. T125/ER25)	Z091.103.R	RH
T118.998.R	HSK-50E	100	50	50	∅ 2÷20 (Art. T119/ER32)	Z091.001.R	RH

COLLET CHUCKS HSK-63E

ART. T118

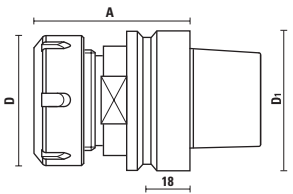

RPM
24.000

T139.163.N

BALLUFF
POCKET

- The hollow taper shank is produced according to DIN69893
- Supplied with nut (without collet)
- Threaded nut and wrenches see page 7.33, spring collets see page 7.26, 7.27, 7.30
- Threaded nut DIN 6499
- The "A" measure will be determined with clamped tool shanks by using our spring collet DIN6499. The "A" measure may be subject to variations depending on the diameter of the clamped tools

Item	Taper	A	D	D1	Spring collets	Clamping nut	Rot.
T118.985.R	HSK-63E	76	50	63	∅ 2÷20 (Art. T119/ER32)	Z091.001.R	RH
T118.985.N	HSK-63E	77	50	63	∅ 2÷20 (Art. T119/ER32)	Z091.101.R ball bearing nut	RH/LH
T118.985.R100	HSK-63E	100	50	63	∅ 2÷20 (Art. T119/ER32)	Z091.001.R	RH
T118.986.R	HSK-63E	76	50	63	∅ 2÷20 (Art. T134/ETS32)	Z091.301.R	RH
T118.987.R	HSK-63E	76	63	63	∅ 2÷30 (Art. T123/ER40)	Z091.002.R	RH
T118.987.N	HSK-63E	78	63	63	∅ 2÷30 (Art. T123/ER40)	Z091.102.R ball bearing nut	RH/LH
T118.988.R	HSK-63E	76	63	63	∅ 2÷25 (Art. T135/ETS40)	Z091.302.R	RH

COLLET CHUCKS HSK-50E WITH FLANGE ∅ 40

ART. T118

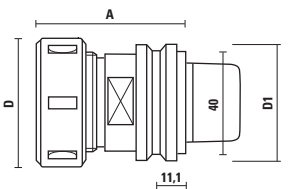

RPM
24.000

T139.150.N

BALLUFF
POCKET

- The hollow taper shank is produced according to DIN69893
- Supplied with nut (without collet)
- Threaded nut and wrenches see page 7.33, spring collets see page 7.27
- Threaded nut DIN 6388 (EOC25)
- The "A" measure will be determined with clamped tool shanks by using our spring collet DIN 6388 (EOC25). The "A" measure may be subject to variations depending on the diameter of the clamped tools

- For ALBERTI "Polar"

Item	Taper	A	D	D1	Spring collets	Clamping nut	Rot.
T118.996.R	HSK-50E	75	60	50	∅ 2÷26 (Art. T124/EOC25)	Z091.203.R ball bearing nut	RH/LH

LONGER COLLET CHUCKS HSK-63F FOR HIGH SPEED PRODUCTION WITH LOW NOISE KleinOVERLINE

The increasing use of 5-axis machines has enabled to step up the possible workings and with it the need to perform operations in tight and hard to reach spaces.

In order to meet these needs with the **utmost precision and excellent finishes** we offer a range of special HSK63F tool holders for collets **ER16, ER32 and DIN6388/EOC25**, balanced at grade **G 2.5 at 36,000 RPM**.

Main features **KleinOVERLINE**

- Accessibility
- Balance
- Rotation speed
- Noiselessness
- Extended length tool holders, reaching 200 mm.
- G 2.5 balancing grade
- 36.000 RPM
- No-noise nuts, with ground contours

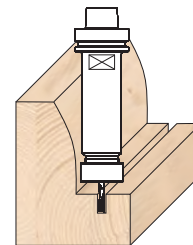

COLLET CHUCKS HSK-63F ER16 - G2.5 BALANCING

ART. TK118

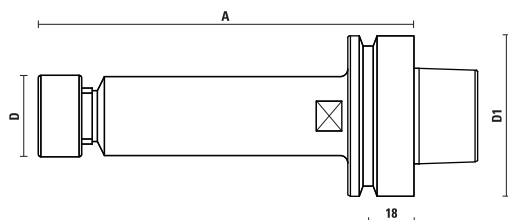

KleinOVERLINE

- The hollow taper shank is produced according to DIN69893
- **Balanced at grade G 2.5 to 36.000 RPM**
- **Noise and vibrations reduction thanks to the special nut without cuts**
- Supplied with nut (without collet)
- Threaded nut and wrenches see page 7.33, spring collets see page 7.29
- Threaded nut DIN 6499
- The "A" measure will be determined with clamped tool shanks by using our spring collet DIN6499. The "A" measure may be subject to variations depending on the diameter of the clamped tools.

RPM 36.000 **BALLUFF POCKET**

Item	Taper	A	D	D1	Spring collets	Clamping nut	Rot.
TK118.900.R070	HSK-63F	70	32	63	∅ 1÷10 (Art. T127/ER16)	Z091.505.R	RH
TK118.900.R100	HSK-63F	100	32	63	∅ 1÷10 (Art. T127/ER16)	Z091.505.R	RH
TK118.900.R150	HSK-63F	150	32	63	∅ 1÷10 (Art. T127/ER16)	Z091.505.R	RH

COLLET CHUCKS HSK-63F ER32 - G2.5 BALANCING

ART. TK118

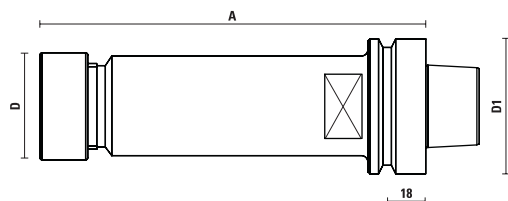

KleinOVERLINE

- The hollow taper shank is produced according to DIN69893
- **Balanced at grade G 2.5 to 36.000 RPM**
- **Noise and vibrations reduction thanks to the special nut without cuts**
- Supplied with nut (without collet)
- Threaded nut and wrenches see page 7.33, spring collets see page 7.26
- Threaded nut DIN 6499
- The "A" measure will be determined with clamped tool shanks by using our spring collet DIN6499. The "A" measure may be subject to variations depending on the diameter of the clamped tools.

RPM 36.000 **BALLUFF POCKET**

Item	Taper	A	D	D1	Spring collets	Clamping nut	Rot.
TK118.976.R075	HSK-63F	75	50	63	∅ 2÷20 (Art. T119/ER32)	Z091.501.R	RH
TK118.976.R100	HSK-63F	100	50	63	∅ 2÷20 (Art. T119/ER32)	Z091.501.R	RH
TK118.976.R125	HSK-63F	125	50	63	∅ 2÷20 (Art. T119/ER32)	Z091.501.R	RH
TK118.976.R180	HSK-63F	180	50	63	∅ 2÷20 (Art. T119/ER32)	Z091.501.R	RH

COLLET CHUCKS HSK-63F DIN6388/EOC25 - G2.5 BALANCING

ART. TK118

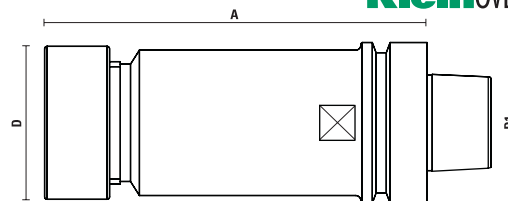

KleinOVERLINE

- The hollow taper shank is produced according to DIN69893
- **Balanced at grade G 2.5 to 36.000 RPM**
- **Noise and vibrations reduction thanks to the special nut without cuts**
- Supplied with nut (without collet)
- Threaded nut and wrenches see page 7.33, spring collets see page 7.27
- Threaded nut DIN 6499
- The "A" measure will be determined with clamped tool shanks by using our spring collet DIN6499. The "A" measure may be subject to variations depending on the diameter of the clamped tools.

RPM 36.000 **BALLUFF POCKET**

Item	Taper	A	D	D1	Spring collets	Clamping nut	Rot.
TK118.984.R078	HSK-63F	78	60	63	∅ 2÷26 (Art. T124/EOC25)	Z091.522.R	RH
TK118.984.R115	HSK-63F	115	60	63	∅ 2÷26 (Art. T124/EOC25)	Z091.522.R	RH
TK118.984.R150	HSK-63F	150	60	63	∅ 2÷26 (Art. T124/EOC25)	Z091.522.R	RH
TK118.984.R200	HSK-63F	200	60	63	∅ 2÷26 (Art. T124/EOC25)	Z091.522.R	RH

COLLET CHUCKS HSK-63F ER16 - G2.5 BALANCING

ART. TJ118

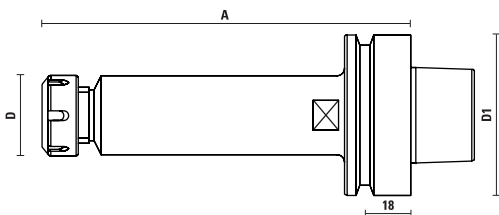

- The hollow taper shank is produced according to DIN69893
- **Balanced at G2.5**
- Maximum speed rotation at **36.000 RPM**
- Supplied with standard clamping nut
- Threaded nut and wrenches (see page 7.33)
- The "A" measure will be determined with clamped tool shanks by using our spring collet DIN6499. The "A" measure may be subject to variations depending on the diameter of the clamped tools.

RPM
36.000



BALLUFF
POCKET

Item	Taper	A	D	D1	Spring collets	Clamping nut	Rot.
TJ118.900.R070	HSK-63F	70	32	63	∅ 1÷10 (Art. T127/ER16)	Z091.105.R	RH
TJ118.900.R100	HSK-63F	100	32	63	∅ 1÷10 (Art. T127/ER16)	Z091.105.R	RH
TJ118.900.R150	HSK-63F	150	32	63	∅ 1÷10 (Art. T127/ER16)	Z091.105.R	RH

COLLET CHUCKS HSK-63F ER32 - G2.5 BALANCING

ART. TJ118

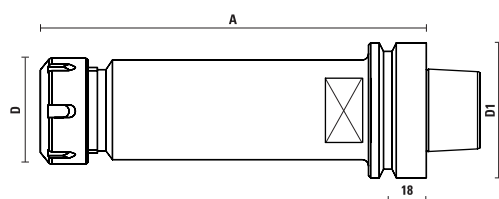

- The hollow taper shank is produced according to DIN69893
- **Balanced at G2.5**
- Maximum speed rotation at **36.000 RPM**
- Supplied with standard clamping nut
- Threaded nut and wrenches (see page 7.33)
- The "A" measure will be determined with clamped tool shanks by using our spring collet DIN6499. The "A" measure may be subject to variations depending on the diameter of the clamped tools.

RPM
36.000



BALLUFF
POCKET

Item	Taper	A	D	D1	Spring collets	Clamping nut	Rot.
TJ118.976.R075	HSK-63F	75	50	63	∅ 2÷20 (Art. T119/ER32)	Z091.001.R	RH
TJ118.976.R100	HSK-63F	100	50	63	∅ 2÷10 (Art. T119/ER32)	Z091.001.R	RH
TJ118.976.R125	HSK-63F	125	50	63	∅ 2÷20 (Art. T119/ER32)	Z091.001.R	RH
TJ118.976.R180	HSK-63F	180	50	63	∅ 2÷20 (Art. T119/ER32)	Z091.001.R	RH

COLLET CHUCKS HSK-63F DIN6388/EOC25 - G2.5 BALANCING

ART. TJ118

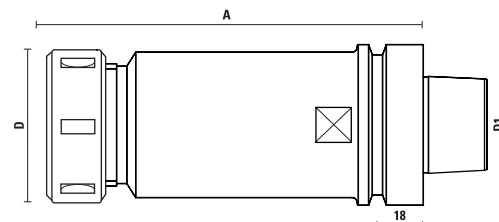

- The hollow taper shank is produced according to DIN69893
- **Balanced at G2.5**
- Maximum speed rotation at **36.000 RPM**
- Supplied with standard clamping nut
- Threaded nut and wrenches (see page 7.33)
- The "A" measure will be determined with clamped tool shanks by using our spring collet DIN6499. The "A" measure may be subject to variations depending on the diameter of the clamped tools.

RPM
36.000



BALLUFF
POCKET

Item	Taper	A	D	D1	Spring collets	Clamping nut	Rot.
TJ118.984.R078	HSK-63F	78	60	63	∅ 2÷26 (Art. T124/EOC25)	Z091.202.R	RH
TJ118.984.R115	HSK-63F	115	60	63	∅ 2÷26 (Art. T124/EOC25)	Z091.202.R	RH
TJ118.984.R150	HSK-63F	150	60	63	∅ 2÷26 (Art. T124/EOC25)	Z091.202.R	RH
TJ118.984.R200	HSK-63F	200	60	63	∅ 2÷26 (Art. T124/EOC25)	Z091.202.R	RH

COLLET CHUCKS DIN 6499 (ER32) FOR BACCI AND GREDA

ART. T118

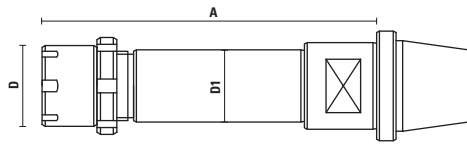

- Supplied with ER20 Mini nut and return ring nut (without spring collet)

- The "A" measure will be determined with clamped tool shanks by using our spring collet DIN 6499. The "A" measure may be subject to variations depending on the diameter of the clamped tools

RPM
24.000

For: Bacci/Greda

Item	A	D	D1	Spring collets	Clamping nut	Return ring nut	Rot.
T118.935.R	85	28	25	∅ 2÷13 (Art. T126/ER20)	Z091.404.R (ER20 Mini)	Z091.904.R	RH

COLLET CHUCKS HSK-85 FOR WEINIG

ART. T132

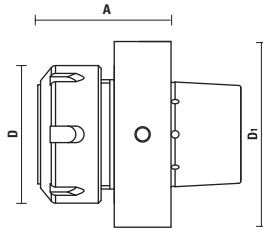

- The hollow taper shank is produced according to DIN69893

- Supplied with nut (without collet)

- Threaded nut DIN 6499

- The "A" measure will be determined with clamped tool shanks by using our spring collet DIN6499. The "A" measure may be subject to variations depending on the diameter of the clamped tools

RPM
24.000



BALLUFF
POCKET

For Weinig machine

Item	Taper	A	D	D1	Spring collets	Clamping nut	Rot.
T132.982.R	HSK-85	61	63	85	∅ 2÷30 (Art. T123/ER40)	Z091.102.R with ball bearing nut	Rh-Lh

STRAIGHT SHANK TOOL EXTENSION

ART. T121

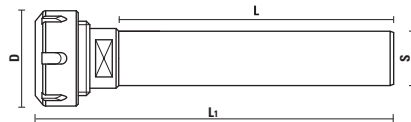

- To be used on ER tool holders

- Suitable for working deep and hard to reach surfaces

Item	D	Spring collets	Clamping nut	S	L	L1	Rot.
T121.016.120.080	22	∅ 2÷10 (Art. T127/ER16)	Z091.405.R Mini	12	80	118	RH
T121.016.160.100	22	∅ 2÷10 (Art. T127/ER16)	Z091.405.R Mini	16	100	138	RH
T121.016.200.100	22	∅ 2÷10 (Art. T127/ER16)	Z091.405.R Mini	20	100	131	RH
T121.016.200.160	22	∅ 2÷10 (Art. T127/ER16)	Z091.405.R Mini	20	160	191	RH
T121.016.200.200	22	∅ 2÷10 (Art. T127/ER16)	Z091.405.R Mini	20	200	231	RH
T121.020.160.100	28	∅ 2÷13 (Art. T126/ER20)	Z091.404.R Mini	16	100	142	RH
T121.020.160.160	28	∅ 2÷13 (Art. T126/ER20)	Z091.404.R Mini	16	160	202	RH
T121.020.200.100	28	∅ 2÷13 (Art. T126/ER20)	Z091.404.R Mini	20	100	137	RH
T121.020.200.160	28	∅ 2÷13 (Art. T126/ER20)	Z091.404.R Mini	20	160	197	RH
T121.020.250.160	28	∅ 2÷13 (Art. T126/ER20)	Z091.404.R Mini	25	160	188	RH
T121.020.250.240	28	∅ 2÷13 (Art. T126/ER20)	Z091.404.R Mini	25	240	282	RH
T121.025.200.060	35	∅ 3÷16 (Art. T125/ER25)	Z091.403.R Mini	20	60	106	RH
T121.025.200.100	35	∅ 3÷16 (Art. T125/ER25)	Z091.403.R Mini	20	100	146	RH
T121.025.200.160	35	∅ 3÷16 (Art. T125/ER25)	Z091.403.R Mini	20	160	206	RH
T121.025.250.100	42	∅ 3÷16 (Art. T125/ER25)	Z091.103.R	25	100	140	RH
T121.025.250.160	42	∅ 3÷16 (Art. T125/ER25)	Z091.103.R	25	160	200	RH

Example of use:

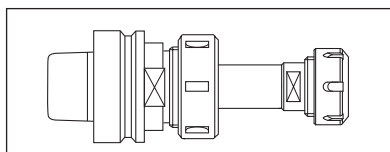

- For a proper use and maximum holding power, fill the collet all the way with the extension shank;
- It is very important to tighten the collet nut of tool holder to recommended torque using a torque wrench;
- When the extension is mounted, balancing grade is not guaranteed.

STAINLESS STEEL COLLET CHUCKS

- Solid stainless steel collet chucks are more resistant and have a longer life span;
- A special treatment guarantees an excellent resistance to corrosion and an aesthetic pleasing;
- No problems of peeling compared to coated chrome chucks of our competitors;
- Better working performances and longer life of the electrospindles;

- Produced in stainless steel AISI 420;
- Needed when working with coolant: machines for marble, glass, aluminium working and others;
- Highly recommended when processing resinoid wood and composite materials;
- Suggested when working in "humid" environment;
- Extremely low maintenance costs, easy to clean.



COLLET CHUCKS ISO 30 INOX

ART. T118

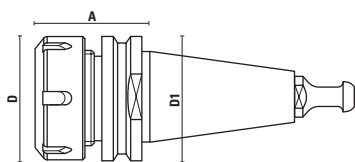

- The hollow taper shank is produced according to DIN69893
- The "A" measure will be determined with clamped tool shanks by using our spring collet DIN6499. The "A" measure may be subject to variations depending on the diameter of the clamped tools.

RPM
24.000



BALLUFF
POCKET

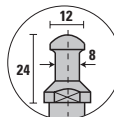

Item T118.891.R For:
Biesse (after 09/09/92),
Masterwood - Bulleri (motor H.S.D.), **Vitap, Hiteco**

Item	Taper	A	D	D1	Spring collets	Clamping nut	Rot.
T118.800.RAI	ISO 30	50	50	50	∅ 2÷20 (Art. T119/ER32)	Z091.001.R	RH
T118.802.RAI	ISO 30	50	50	50	∅ 2÷20 (Art. T119/ER32)	Z091.101.R ball bearing nut	RH/LH
T118.830.RAI	ISO 30	55	63	50	∅ 2÷30 (Art. T123/ER40)	Z091.002.R	RH
T118.832.RAI	ISO 30	55	63	50	∅ 2÷30 (Art. T123/ER40)	Z091.102.R ball bearing nut	RH/LH

RPM
24.000



BALLUFF
POCKET

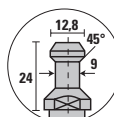

Item T118.792.R For:
Alberti, Vitap, Masterwood (motor G. Colombo)

Item	Taper	A	D	D1	Spring collets	Clamping nut	Rot.
T118.811.RAI	ISO 30	50	50	50	∅ 2÷20 (Art. T119/ER32)	Z091.001.R	RH
T118.813.RAI	ISO 30	50	50	50	∅ 2÷20 (Art. T119/ER32)	Z091.101.R ball bearing nut	RH/LH
T118.815.RAI	ISO 30	55	63	50	∅ 2÷30 (Art. T123/ER40)	Z091.002.R	RH
T118.817.RAI	ISO 30	55	63	50	∅ 2÷30 (Art. T123/ER40)	Z091.102.R ball bearing nut	RH/LH

RPM
24.000



BALLUFF
POCKET

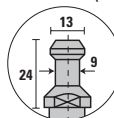

Item T118.791.R (DIN 69872) For:
Anderson, Busellato, Weeke, Ima, Bulleri, Maka, Cosmec, Reichenbacher, Elte

Item	Taper	A	D	D1	Spring collets	Clamping nut	Rot.
T118.821.RAI	ISO 30	50	50	50	∅ 2÷20 (Art. T119/ER32)	Z091.001.R	RH
T118.823.RAI	ISO 30	50	50	50	∅ 2÷20 (Art. T119/ER32)	Z091.101.R ball bearing nut	RH/LH
T118.825.RAI	ISO 30	55	63	50	∅ 2÷30 (Art. T123/ER40)	Z091.002.R	RH
T118.827.RAI	ISO 30	55	63	50	∅ 2÷30 (Art. T123/ER40)	Z091.102.R ball bearing nut	RH/LH

COLLET CHUCKS HSK-63F INOX

ART. T118

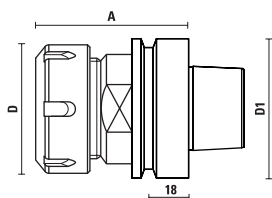

- The hollow taper shank is produced according to DIN69893
- The "A" measure will be determined with clamped tool shanks by using our spring collet DIN6499. The "A" measure may be subject to variations depending on the diameter of the clamped tools.

RPM
24.000



BALLUFF
POCKET

Item	Taper	A	D	D1	Spring collets	Clamping nut	Rot.
T118.976.RAI	HSK-63F	74	50	63	∅ 2÷20 (Art. T119/ER32)	Z091.001.R	RH
T118.978.RAI	HSK-63F	74	50	63	∅ 2÷20 (Art. T119/ER32)	Z091.101.R ball bearing nut	RH/LH
T118.980.RAI	HSK-63F	77	63	63	∅ 2÷30 (Art. T123/ER40)	Z091.002.R	RH
T118.982.RAI	HSK-63F	77	63	63	∅ 2÷30 (Art. T123/ER40)	Z091.102.R ball bearing nut	RH/LH
T118.983.RAI	HSK-63F	78	60	63	∅ 2÷26 (Art. T124/EOC25)	Z091.202.R	RH
T118.984.RAI	HSK-63F	78	60	63	∅ 2÷26 (Art. T124/EOC25)	Z091.203.R ball bearing nut	RH/LH

COLLET CHUCKS ISO 30 FOR MULTIAX

ART. T118

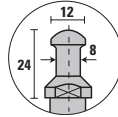
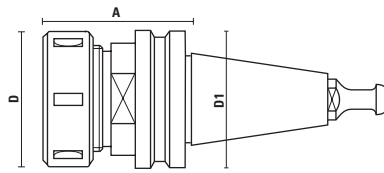

- Supplied with nut (without collet) and retaining pawl
- The "A" measure will be determined with clamped tool shanks by using our spring collet
The "A" measure may be subject to variations depending on the diameter of the clamped tools
- To be used with our spring collets with 3° taper angle only (see item T133 at page 7.30)
- **Special micro-shot peening treatment**

Item T118.891.R for:
Biesse, Masterwood, Multiax, Vitap, Hiteco

Item	Taper	A	D	D1	Spring collets	Clamping nut	Rot.
T118.841.R	ISO 30	58	50	50	∅ 3÷25,4	Z091.005.R	RH

COLLET CHUCKS HSK-63F FOR MULTIAX

ART. T118

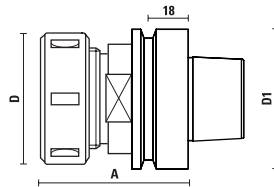

- Supplied with nut (without collet) and retaining pawl
- The "A" measure will be determined with clamped tool shanks by using our spring collet
The "A" measure may be subject to variations depending on the diameter of the clamped tools
- To be used with our spring collets with 3° taper angle only (see item T133 at page 7.30)
- **Special micro-shot peening treatment**

For: **Multiax**

Item	Taper	A	D	D1	Spring collets	Clamping nut	Rot.
T118.941.R	HSK 63F	58	50	63	∅ 3÷25,4	Z091.005.R	RH
T118.941.L	HSK-63F	58	50	63	∅ 3÷25,4	Z091.005.R	LH

SPRING COLLETS

Our **HIGH-PRECISION spring collets** are produced in Italy and have 0,01 mm precision (0.0004" TIR) with perfect precision and reliability, ensuring longer tool life of the spindle and better working operations. They are fully grounded both externally and internally; after this operation there is a second phase of finishing which aims to eliminate all ridges and burrs from machining by obtaining a surface "superfinish" by ensuring a grade of roughness lower than Rz 2,5. They are completely quenched and tempered (HRC 45+2). Our line of **ULTRA-PRECISE spring collets** are produced to give to the tool holders and spindle the maximum efficiency based on the balancing grade. They are made in special spring steel with a concentricity specification of 0,005 mm (0.0002" TIR).

HOW TO INSERT THE SPRING COLLET IN THE NUT

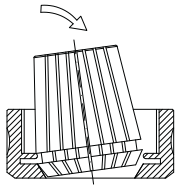

Right procedure to assemble the collet in the nut:

- place the collet diagonal to the clamping nut and lock it from the side by pressing it from top
- screw the nut and be sure the shank is correctly inserted in the spring collet.

Tighten the nut using the apposite key on the proper demount device (Art. T139, see page 7.41)

Do not place the spring collet in the collet chuck before you have it properly inserted in the nut.

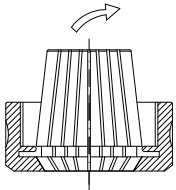

Correct procedure for tool and spring collet change:

- place the collet chuck in the mounting device
- untighten the clamping nut
- open the clamping nut and pull the cutting tool out holding it on the shank
- release the collet from the clamping nut by lateral pressure

CONCENTRICITY

Using high precision spring collets, vibrations on the tools and motors are reduced, assuring better results and a longer life of the tools and electro-spindles.

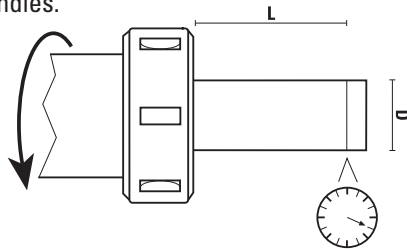

D	L	Standard High Precision Klein [®] HP >0,010	Ultra Precision Klein [®] UP >0,005
Ø3 - Ø4 - Ø5	16	> 0,010	> 0,005
Ø6 ÷ Ø9,5	25	> 0,010	> 0,005
Ø10 ÷ Ø17	40	> 0,010	> 0,005
Ø18 ÷ Ø26	50	> 0,010	> 0,005

TECHNICAL INFORMATION

Type	ER11 4008 E - DIN 6499	ER16 426 E - DIN 6499	ER20 428 E - DIN 6499	ER25 430 E - DIN 6499	ER32 470 E - DIN 6499	ER40 472 E - DIN 6499	EOC12 SY0220-407 E DIN 6388	EOC16 R0025-415 E DIN 6388	EOC25 SY0225-462E DIN 6388
Diameter range	1÷7	1÷10	2÷13	1÷16	2÷20	2÷30	4÷12,7	4÷12,7	2÷25,4
Clamping range	0,5	0,5÷1	0,5÷1	0,5÷1	0,5÷1	0,5÷1	0,5	0,5	0,5

COLLET LIFE SPAN

Spring collets have a life span of approximately 3 months if used 8 hours a day. Replacing the collets will ensure your operation runs consistency and prevents from tool breakag.



MAINTENANCE

Keeping spring collets and tools clean is essential for a longer life. The worked material produces chips and dirt which can cause an elliptical tool rotation. The seats of collet chucks and electrospindles should be cleaned daily with the correct tapers (see our items **T137** and **X137** at the page 7.40).

DID YOU KNOW?

Collets are manufactured from spring steel and regular usage causes a loss of elasticity. Therefore, collets need to be replaced regularly as part of on-going maintenance while the average collet should be replaced every 500-600 hours of run time. Avoiding regular replacement can lead to brittle collets, which may crack or break, and cause permanent damage to the spindle. Replacement of collets is more economical than replacing router bits or expensive spindles. Rigidity and concentricity are the key elements in any routing application. Periodically, tool holders should be examined for wear and if necessary replaced to maintain great cutting performance. The simple process of colletting router tools, maintaining collets, and regularly replacing them - safeguards productivity and ensures a perfect finish.



SPRING COLLETS ER 32 - DIN 6499

ART. T119

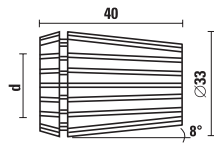
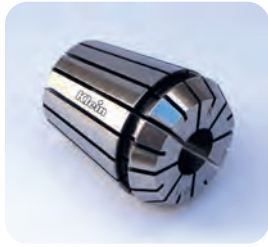

HP
>0,010

Item	d
T119.020.N	Ø 2 - 1
T119.030.N	Ø 3 - 2
T119.032.N	Ø 3,2 (1/8")
T119.040.N	Ø 4 - 3
T119.048.N	Ø 4,8 (3/16")
T119.050.N	Ø 5 - 4
T119.060.N	Ø 6 - 5
T119.064.N	Ø 6,4 (1/4")
T119.070.N	Ø 7 - 6
T119.079.N	Ø 7,9 (5/16")
T119.080.N	Ø 8 - 7
T119.090.N	Ø 9 - 8
T119.095.N	Ø 9,5 (3/8")
T119.100.N	Ø 10 - 9
T119.110.N	Ø 11 - 10
T119.120.N	Ø 12 - 11
T119.127.N	Ø 12,7 (1/2")
T119.130.N	Ø 13 - 12
T119.140.N	Ø 14 - 13
T119.150.N	Ø 15 - 14
T119.159.N	Ø 15,9 (5/8")
T119.160.N	Ø 16 - 15
T119.170.N	Ø 17 - 16
T119.180.N	Ø 18 - 17
T119.190.N	Ø 19 - 18
T119.191.N	Ø 19,1 (3/4")
T119.200.N	Ø 20 - 19

ULTRA PRECISION SPRING COLLETS ER 32 - DIN 6499

ART. T119.UP

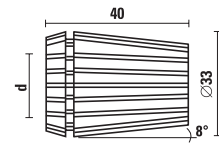
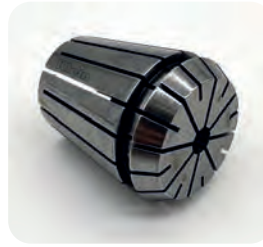

UP
>0,005

- Recommended for high speed RPM where great machining precision is required
- Nominal diameter
- To be used on all types of toolholders and standard nuts

Item	d
T119.030.NUP	Ø 3
T119.040.NUP	Ø 4
T119.060.NUP	Ø 6
T119.080.NUP	Ø 8
T119.100.NUP	Ø 10
T119.120.NUP	Ø 12
T119.140.NUP	Ø 14
T119.160.NUP	Ø 16
T119.180.NUP	Ø 18
T119.200.NUP	Ø 20

SPRING COLLET SET ER 32 - DIN 6499

ART. X119



- Complete with 18 pcs
- In plastic Box

HP
>0,010

Item	Diameters:
X119.118.N	Ø3 - Ø4 - Ø5 - Ø6 - Ø7 - Ø8
	Ø9 - Ø10 - Ø11 - Ø12 - Ø13 - Ø14
	Ø15 - Ø16 - Ø17 - Ø18 - Ø19 - Ø20

SPRING COLLETS ER 40 - DIN 6499

ART. T123

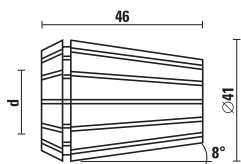
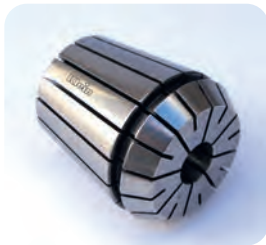

HP
>0,010

Item	d
T123.030.N	Ø 3 - 2
T123.032.N	Ø 3,2 (1/8")
T123.040.N	Ø 4 - 3
T123.048.N	Ø 4,8 (3/16")
T123.050.N	Ø 5 - 4
T123.060.N	Ø 6 - 5
T123.064.N	Ø 6,4 (1/4")
T123.070.N	Ø 7 - 6
T123.079.N	Ø 7,9 (5/16")
T123.080.N	Ø 8 - 7
T123.090.N	Ø 9 - 8
T123.095.N	Ø 9,5 (3/8")
T123.100.N	Ø 10 - 9
T123.110.N	Ø 11 - 10
T123.120.N	Ø 12 - 11
T123.127.N	Ø 12,7 (1/2")
T123.130.N	Ø 13 - 12
T123.140.N	Ø 14 - 13
T123.150.N	Ø 15 - 14
T123.159.N	Ø 15,9 (5/8")
T123.160.N	Ø 16 - 15
T123.170.N	Ø 17 - 16
T123.180.N	Ø 18 - 17
T123.190.N	Ø 19 - 18
T123.191.N	Ø 19,1 (3/4")
T123.200.N	Ø 20 - 19
T123.210.N	Ø 21 - 20
T123.220.N	Ø 22 - 21
T123.230.N	Ø 23 - 22
T123.240.N	Ø 24 - 23
T123.250.N	Ø 25 - 24
T123.254.N	Ø 25,4 (1")
T123.260.N	Ø 26 - 25
T123.300.N	Ø 30 - 29

SPRING COLLET SET ER 40 - DIN 6499

ART. X123



- Complete with 23 pcs
- In carton Box

HP
>0,010

Item	Diameters:
X123.023.N	Ø3 - Ø4 - Ø5 - Ø6 - Ø7 - Ø8 Ø9 - Ø10 - Ø11 - Ø12 - Ø13 - Ø14 Ø15 - Ø16 - Ø17 - Ø18 - Ø19 - Ø20 Ø21 - Ø22 - Ø23 - Ø24 - Ø25

ULTRA PRECISION SPRING COLLETS ER 40 - DIN 6499

ART. T123.UP

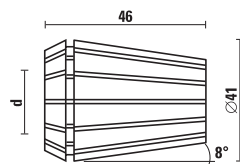

UP
>0,005

- Recommended for high speed RPM where great machining precision is required
- Nominal diameter
- To be used on all types of toolholders and standard nuts

Item	d
T123.060.NUP	Ø 6
T123.080.NUP	Ø 8
T123.100.NUP	Ø 10
T123.120.NUP	Ø 12
T123.140.NUP	Ø 14
T123.160.NUP	Ø 16
T123.180.NUP	Ø 18
T123.200.NUP	Ø 20
T123.250.NUP	Ø 25

SPRING COLLETS EOC25 - DIN 6388 (462 E)

ART. T124

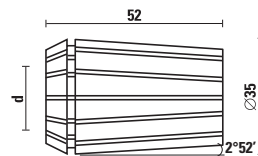

HP
>0,008

Item	d
T124.020.N	Ø 2 - 1,5
T124.030.N	Ø 3 - 2,5
T124.032.N	Ø 3,2 (1/8")
T124.040.N	Ø 4 - 3,5
T124.048.N	Ø 4,8 (3/16")
T124.050.N	Ø 5 - 4,5
T124.060.N	Ø 6 - 5,5
T124.064.N	Ø 6,4 (1/4")
T124.070.N	Ø 7 - 6,5
T124.079.N	Ø 7,9 (5/16")
T124.080.N	Ø 8 - 7,5
T124.095.N	Ø 9,5 (3/8")
T124.100.N	Ø 10 - 9,5
T124.110.N	Ø 11 - 10,5
T124.120.N	Ø 12 - 11,5
T124.127.N	Ø 12,7 (1/2")
T124.130.N	Ø 13 - 12,5
T124.140.N	Ø 14 - 13,5
T124.159.N	Ø 15,9 (5/8")
T124.160.N	Ø 16 - 15,5
T124.180.N	Ø 18 - 17,5
T124.190.N	Ø 19 - 18,5
T124.191.N	Ø 19,1 (3/4")
T124.200.N	Ø 20 - 19,5
T124.220.N	Ø 22 - 21,5
T124.250.N	Ø 25 - 24,5
T124.254.N	Ø 25,4 (1")

SPRING COLLETS ER 25 - DIN 6499

ART. T125

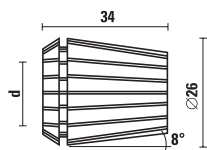

HP
>0,010

Item	d
T125.016.N	Ø 1,59 (1/16")
T125.020.N	Ø 2 - 1
T125.030.N	Ø 3 - 2
T125.032.N	Ø 3,2 (1/8")
T125.040.N	Ø 4 - 3
T125.048.N	Ø 4,8 (3/16")
T125.050.N	Ø 5 - 4
T125.060.N	Ø 6 - 5
T125.064.N	Ø 6,4 (1/4")
T125.070.N	Ø 7 - 6
T125.079.N	Ø 7,9 (5/16")
T125.080.N	Ø 8 - 7
T125.090.N	Ø 9 - 8
T125.095.N	Ø 9,5 (3/8")
T125.100.N	Ø 10 - 9
T125.110.N	Ø 11 - 10
T125.120.N	Ø 12 - 11
T125.127.N	Ø 12,7 (1/2")
T125.130.N	Ø 13 - 12
T125.140.N	Ø 14 - 13
T125.150.N	Ø 15 - 14
T125.159.N	Ø 15,9 (5/8")
T125.160.N	Ø 16 - 15

ULTRA PRECISION SPRING COLLETS ER 25 - DIN 6499

ART. T125.UP

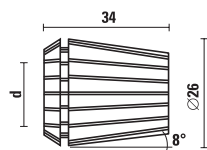

UP
>0,005

- Recommended for high speed RPM where great machining precision is required
- Nominal diameter
- To be used on all types of toolholders and standard nuts

Item	d
T125.060.NUP	Ø 6
T125.080.NUP	Ø 8
T125.100.NUP	Ø 10
T125.120.NUP	Ø 12

SPRING COLLET SET ER25 - DIN 6499

ART. X125



- Complete with 14 pcs
- In wooden Box

Item	Diameters: Ø3 - Ø4 - Ø5 - Ø6 - Ø7 - Ø8 - Ø9 - Ø10 - Ø11 - Ø12 - Ø13 - Ø14 - Ø15 - Ø16
X125.014.N	

SPRING COLLETS ER 20 - DIN 6499

ART. T126

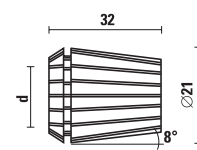

HP
>0,010

Item	d
T126.016.N	Ø 1,59 (1/16")
T126.030.N	Ø 3 - 2
T126.032.N	Ø 3,2 (1/8")
T126.040.N	Ø 4 - 3
T126.048.N	Ø 4,8 (3/16")
T126.050.N	Ø 5 - 4
T126.060.N	Ø 6 - 5
T126.064.N	Ø 6,4 (1/4")
T126.070.N	Ø 7 - 6
T126.080.N	Ø 8 - 7
T126.090.N	Ø 9 - 8
T126.095.N	Ø 9,5 (3/8")
T126.100.N	Ø 10 - 9
T126.110.N	Ø 11 - 10
T126.120.N	Ø 12 - 11
T126.127.N	Ø 12,7 (1/2")
T126.130.N	Ø 13 - 12

ULTRA PRECISION SPRING COLLETS ER 20 - DIN 6499

ART. T126.UP

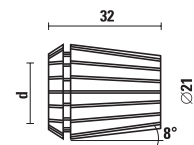

UP
>0,005

- Recommended for high speed RPM where great machining precision is required
- Nominal diameter
- To be used on all types of toolholders and standard nuts

Item	d
T126.060.NUP	Ø 6
T126.080.NUP	Ø 8
T126.100.NUP	Ø 10
T126.120.NUP	Ø 12

SPRING COLLETS ER 16 - DIN 6499

ART. T127

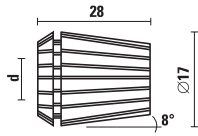

HP
>0,010

Item	d
T127.016.N	Ø 1,59 (1/16")
T127.020.N	Ø 2 - 1
T127.030.N	Ø 3 - 2
T127.032.N	Ø 3,2 (1/8")
T127.040.N	Ø 4 - 3
T127.050.N	Ø 5 - 4
T127.060.N	Ø 6 - 5
T127.064.N	Ø 6,4 (1/4")
T127.070.N	Ø 7 - 6
T127.080.N	Ø 8 - 7
T127.090.N	Ø 9 - 8
T127.095.N	Ø 9,5 (3/8")
T127.100.N	Ø 10 - 9

ULTRA PRECISION SPRING COLLETS ER 16 - DIN 6499

ART. T127.UP

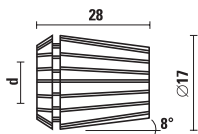

- Recommended for high speed RPM where great machining precision is required
- Nominal diameter
- To be used on all types of toolholders and standard nuts

UP
>0,005

Item	d
T127.060.NUP	Ø 6
T127.080.NUP	Ø 8
T127.100.NUP	Ø 10

SPRING COLLETS ER 11 - DIN 6499

ART. T129

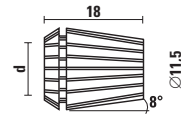

HP
>0,010

Articolo/Item	d
T129.010.N	Ø 1-0,5
T129.015.N	Ø 1,5-1
T129.020.N	Ø 2-1,5
T129.025.N	Ø 2,5-2
T129.030.N	Ø 3-2,5
T129.032.N	Ø 3,2 (1/8")
T129.035.N	Ø 3,5-3
T129.040.N	Ø 4-3,5
T129.045.N	Ø 4,5-4
T129.048.N	Ø 4,8 (3/16")
T129.050.N	Ø 5-4,5
T129.055.N	Ø 5,5-5
T129.060.N	Ø 6-5,5
T129.064.N	Ø 6,4 (1/4")
T129.065.N	Ø 6,5-6
T129.070.N	Ø 7-6,5

SPRING COLLETS EOC12 - DIN 6388 (407E)

ART. T136

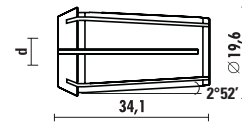

- To be used with Art. T118.580.R

HP
>0,010

Item	d
T136.040.N	Ø 4 - 3
T136.060.N	Ø 6 - 5
T136.064.N	Ø 6,4 (1/4")
T136.080.N	Ø 8 - 7
T136.095.N	Ø 9,5 (3/8")
T136.100.N	Ø 10 - 9
T136.120.N	Ø 12 - 11
T136.127.N	Ø 12,7 (1/2")

SPRING COLLETS EOC16 - DIN 6388 (415E)

ART. T138

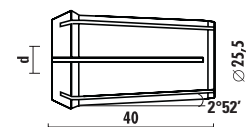

HP
>0,010

Item	d
T138.040.N	Ø 4 - 3
T138.060.N	Ø 6 - 5
T138.064.N	Ø 6,4 (1/4")
T138.080.N	Ø 8 - 7
T138.095.N	Ø 9,5 (3/8")
T138.100.N	Ø 10 - 9
T138.120.N	Ø 12 - 11
T138.127.N	Ø 12,7 (1/2")

SPRING COLLETS 3° TAPER ANGLE FOR MULTIAX

ART. T133

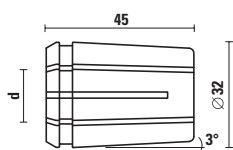
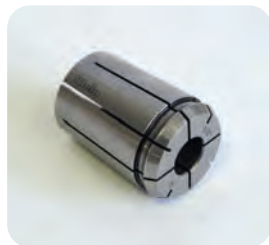

To be used with our tool holders (see item T118.941.R and T118.841.R) for Multiax router machines only.

HP
>0,010

Item	d	Item	d
T133.032.N	Ø 3,2 (1/8")	T133.120.N	Ø 12 - 11
T133.040.N	Ø 4 - 3	T133.127.N	Ø 12,7 (1/2")
T133.060.N	Ø 6 - 5	T133.159.N	Ø 15,9 (5/8")
T133.064.N	Ø 6,4 (1/4")	T133.160.N	Ø 16 - 15
T133.079.N	Ø 7,9 (5/16")	T133.191.N	Ø 19,1 (3/4")
T133.080.N	Ø 8 - 7	T133.200.N	Ø 20 - 19
T133.095.N	Ø 9,5 (3/8")	T133.250.N	Ø 25 - 24
T133.100.N	Ø 10 - 9	T133.254.N	Ø 25,4 (1")

SPRING COLLETS ETS 32 - DIN 6499

ART. T134

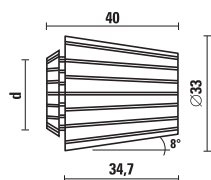
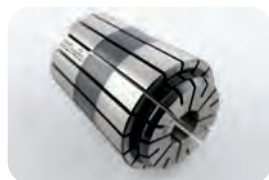

HP
>0,010

Item	d	Item	d
T134.030.N	Ø 3 - 2	T134.120.N	Ø 12 - 11
T134.040.N	Ø 4 - 3	T134.130.N	Ø 13 - 12
T134.050.N	Ø 5 - 4	T134.140.N	Ø 14 - 13
T134.060.N	Ø 6 - 5	T134.160.N	Ø 16 - 15
T134.070.N	Ø 7 - 6	T134.180.N	Ø 18 - 17
T134.080.N	Ø 8 - 7	T134.200.N	Ø 20 - 19
T134.100.N	Ø 10 - 9		

SPRING COLLETS ETS 40 - DIN 6499

ART. T135

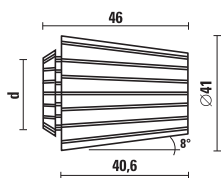
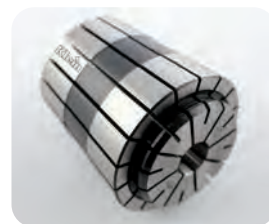

HP
>0,010

Item	d	Item	d
T135.040.N	Ø 4 - 3	T135.130.N	Ø 13 - 12
T135.050.N	Ø 5 - 4	T135.140.N	Ø 14 - 13
T135.060.N	Ø 6 - 5	T135.160.N	Ø 16 - 15
T135.070.N	Ø 7 - 6	T135.180.N	Ø 18 - 17
T135.080.N	Ø 8 - 7	T135.200.N	Ø 20 - 19
T135.100.N	Ø 10 - 9	T135.250.N	Ø 25 - 24
T135.120.N	Ø 12 - 11		

SPRING COLLET SET + WIPE OFF KIT





The **wipe off set** allows maintaining the inside as well as the seat of the spring collet on the chuck clean, helps increasing cutting efficiency and reduce vibrations for a longer tool life. No more risk of wrong positioning of both the collet and the tool due to chips and resin.



- In plastic box

Set complete with:
- nr. 10 spring collets
- Collet wipers
- Brushes for collet bore

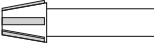

Item	Item
 X125.515.N	
	Set complete with 10 spring collets ER25: Ø3 - Ø4 - Ø5 - Ø6 - Ø7 Ø8 - Ø10 - Ø12 - Ø14 - Ø16

 T137.525.N - Collet wiper ER25
 X137.004.N - nr. 4 brushes for collet bore ER25

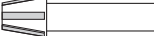

Item	Item
 X119.515.N	
	Set complete with 10 spring collets ER32: Ø4 - Ø5 - Ø6 - Ø8 - Ø10 - Ø12 - Ø14 - Ø16 - Ø18 - Ø20

 T137.532.N - Collet wiper ER32
 X137.004.N - nr. 4 brushes for collet bore ER32

Item	Item
 X123.515.N	
	Set complete with 10 spring collets ER40: Ø4 - Ø6 - Ø8 - Ø10 - Ø12 - Ø14 - Ø16 - Ø18 - Ø20 - Ø25

 T137.540.N - Collet wiper ER40
 X137.004.N - nr. 4 brushes for collet bore ER40

Item	Item
 X124.515.N	
	Set complete with 10 spring collets DIN6388: Ø4 - Ø6 - Ø8 - Ø10 - Ø12 - Ø14 - Ø16 - Ø18 - Ø20 - Ø25

 T137.662.N - Collet wiper DIN6388-EOC25
 X137.004.N - nr. 4 brushes for collet bore DIN6388-EOC25

SET IN WOODEN BOX

ART. X118



Complete with concentric chuck ISO30 + 8 spring collets ER32

Item
X118.700.R

complete with:
concentric chuck ISO 30/ER32
T118.700.R

spring collets	Ø6	T119.060.N
	Ø8	T119.080.N
	Ø10	T119.100.N
	Ø12	T119.120.N
	Ø14	T119.140.N
	Ø16	T119.160.N
	Ø18	T119.180.N
	Ø20	T119.200.N

Item
X118.800.R

complete with:
concentric chuck ISO 30/ER32
T118.800.R

spring collets	Ø6	T119.060.N
	Ø8	T119.080.N
	Ø10	T119.100.N
	Ø12	T119.120.N
	Ø14	T119.140.N
	Ø16	T119.160.N
	Ø18	T119.180.N
	Ø20	T119.200.N

SET IN PLASTIC BOX

ART. X118



- Complete with concentric chuck HSK63F + 8 spring collets ER40

Item
X118.980.R

complete with:
concentric chuck HSK63F/ER40 T118.980.R

spring collets	Ø6	T123.060.N
	Ø8	T123.080.N
	Ø10	T123.100.N
	Ø12	T123.120.N
	Ø16	T123.160.N
	Ø18	T123.180.N
	Ø20	T123.200.N
	Ø25	T123.250.N

SET IN PLASTIC BOX

ART. X118



- Complete with concentric chuck HSK63F + 8 spring collets ER32

Item
X118.976.R

complete with:
concentric chuck HSK63F/ER32 T118.976.R

spring collets	Ø6	T119.060.N
	Ø8	T119.080.N
	Ø10	T119.100.N
	Ø12	T119.120.N
	Ø14	T119.140.N
	Ø16	T119.160.N
	Ø18	T119.180.N
	Ø20	T119.200.N

SET IN PLASTIC BOX

ART. X118



- Complete with concentric chuck HSK63F with ball bearing nut + 8 spring collets EOC25

Item
X118.984.R

complete with:
concentric chuck HSK63F/EOC25 T118.984.R

spring collets	Ø6	T124.060.N
	Ø8	T124.080.N
	Ø10	T124.100.N
	Ø12	T124.120.N
	Ø16	T124.160.N
	Ø18	T124.180.N
	Ø20	T124.200.N
	Ø25	T124.250.N

DUST & CHIP EXTRACTION NUT

ART. T139

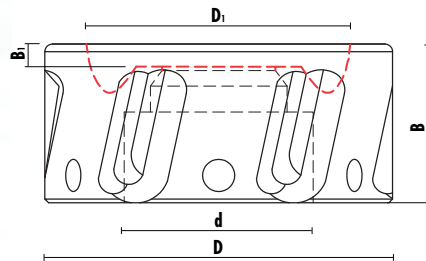

- Tool body in light alloy with a special surface coating against wear and corrosion for a maximum chips evacuation
- Optimal gap between Tornado® and material is 2 mm (0.078"). It works properly up to 10 mm (0.38")
- Smaller diameter: (92 mm) in order to be mounted on every CNC router/machining centre
- Suitable for every type of collet chuck (HSK, ISO, BT, ...)
- Maximum speed rotation at 20.000 RPM
- Balanced at G2,5, weight 0,256 kg



Item	Type	D	D1	B	B1	d	Rot.
T139.501.RK	DIN6499 (ER32)	92	70	40	6	M 40x1,5	RH
T139.502.RK	DIN6499 (ER40)	92	70	42	6	M 50x1,5	RH
T139.503.RK	DIN6499 (ER25)	92	70	42	6	M 32x1,5	RH
T139.522.RK	DIN6388 (EOC25)	92	70	42	6	M 48x2	RH
T139.581.RK	DIN6499 (ER32)	80	64	42	6	M 40x1,5	RH

DUST & CHIP EXTRACTION NUT SET

ART. X139



- Complete with:
n° 1 extraction nut
n° 1 hook wrench:
Ø 92= key 95/100
Ø 80= key 80/90
- Carton box

Item	Description	Type
X139.501.RK	T139.501.RK + Z052.315.N	DIN6499 (ER32)
X139.502.RK	T139.502.RK + Z052.315.N	DIN6499 (ER40)
X139.503.RK	T139.503.RK + Z052.315.N	DIN6499 (ER25)
X139.522.RK	T139.522.RK + Z052.315.N	DIN6388 (EOC25)
X139.581.RK	T139.581.RK + Z052.314.N	DIN6499 (ER32)

Tornado: the new dust & chips extraction nut helps both dust and chip evacuation during Nesting and conventional CNC Routing operations. Easy to assemble directly on the collet chuck instead of the standard nut, the new Klein Tornado® provides a big improvement of dust evacuation, removing it from the workpiece directly into the centralized extraction system of the CNC machines.

DUST & CHIP EXTRACTION NUT SET

ART. X139



- Complete with:
n° 2 extraction nuts (ER32-ER40)
n° 1 hook wrench 95/100
- Carton box

Item	Description
X139.990.RK	T139.501.RK + T139.502.RK + Z052.315.N

TORQUE WRENCHES FOR TORNADO

ART. Z052



Item	Type	L	Nm (dis. 1)	Nm (dis. 2)
Z052.722.N	ER25	480	40-55	80-90
Z052.723.N	ER32	480	66-70	120-130
Z052.724.N	ER40	480	110-120	190-200
Z052.728.N	EOC25	480	110-120	190-200

EASY TO MOUNT LIKE A STANDARD CLAMPING NUT

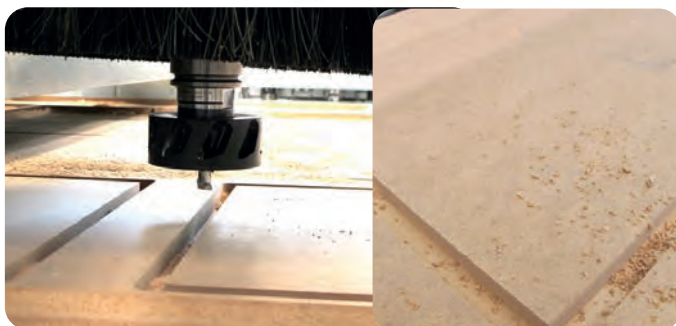

WORKING WITH TORNADO



WORKING WITHOUT TORNADO

TORQUE WRENCHES

While setting a tool it is extremely important to tighten it appropriately. **If not effectively tight indeed a cutting tool could slide away from the tool holder during the working process. On the other side, an excessive tightening can cause damages to the tool holder or spring collet or the tool itself.** The wrench indicates when the torque (Nm) is reached according to the value in the corresponding table.

TORQUE WRENCHES FOR "MINI" NUTS

You can find all spare parts in the section n. 10

ART. Z052

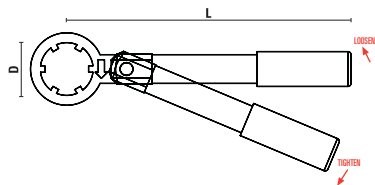



Item	D	L	Nm	Threaded nut
Z052.701.N	16	120	18	ER11
Z052.702.N	22	175	28	ER16
Z052.703.N	28	180	35	ER20
Z052.704.N	35	185	40	ER25

TORQUE WRENCHES FOR "STANDARD" NUTS

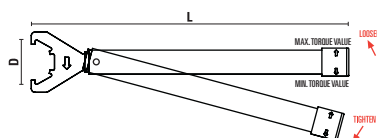
ART. Z052

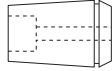

- Dr. ①  Collets as per drawing n. 1 must be tightened by setting the minimum torque value and rotating the handle counterclockwise.
- Dr. ②  Collets as per drawing n. 2 must be tightened by setting the maximum torque value and rotating the handle clockwise.

Item	D	L	Nm (Dr. 1)	Nm (Dr. 2)	Threaded nut
Z052.710.N	32	380	25-35	45-55	ER16
Z052.711.N	35	380	30-40	60-70	ER20
Z052.712.N	40	400	40-55	80-90	ER25
Z052.713.N	50	400	66-70	120-130	ER32
Z052.714.N	63	450	110-120	190-200	ER40

TORQUE HOOK WRENCHES

ART. Z052

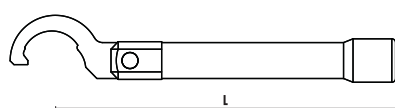

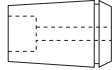
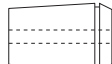

- Dr. ①  Collets as per drawing n. 1 must be tightened by setting the minimum torque value and rotating the handle counterclockwise.
- Dr. ②  Collets as per drawing n. 2 must be tightened by setting the maximum torque value and rotating the handle clockwise.

Item	D	L	Nm (Dr. 1)	Nm (Dr. 2)	Threaded nut
Z052.732.N	58-62	380	110-120	190-200	DIN 6388/EOC25
Z052.735.N	50	380	110-120	190-200	Z091.005.R

TORQUE WRENCHES FOR "NO-NOISE" NUTS

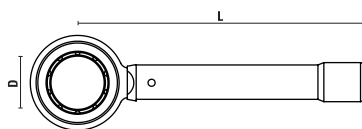
ART. Z052

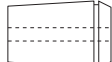

- Dr. ①  Collets as per drawing n. 1 must be tightened by setting the minimum torque value and rotating the handle counterclockwise.
- Dr. ②  Collets as per drawing n. 2 must be tightened by setting the maximum torque value and rotating the handle clockwise.

Item	D	L	Nm (Dr. 1)	Nm (Dr. 2)	Threaded nut
Z052.790.N	32	400	25-35	45-55	ER 16
Z052.793.N	50	400	65-70	120-130	ER 32
Z052.795.N	60	400	110-120	190-200	DIN 6388/EOC25

KEYS

ART. Z052

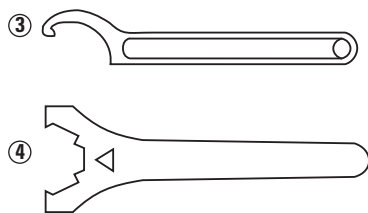

Item	Draw.	Threaded nut	Threaded nut
Z052.300.N	3	DIN6388/EOC12	Wrench 34/38
Z052.301.N	3	Z091.000.R	Wrench 40/42
Z052.305.N	3	Z091.005.R	Wrench 48/50
Z052.310.N	3	DIN6388/EOC25	Wrench 58/62
Z052.314.N	3		Wrench for Tornado
Z052.315.N	3		Wrench for Tornado
Z052.401.N	4	ER 32	
Z052.402.N	4	ER 40	
Z052.404.N	4	ER 20	
Z052.407.N	4	ER 25	
Z052.409.N	4	ER 16	

COLLET NUTS

ART. Z091

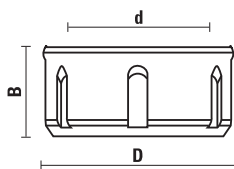

Item	Type	D	B	d	Rot.
Z091.000.R	For spring collets Art. T117	40	20	M 30x1,5	RH
Z091.000.L	For spring collets Art. T117	40	20	M 30x1,5	LH
Z091.001.R	DIN 6499 (ER 32)	50	23	M 40x1,5	RH
Z091.001.L	DIN 6499 (ER 32)	50	23	M 40x1,5	LH
Z091.002.R	DIN 6499 (ER 40)	63	25	M 50x1,5	RH
Z091.002.L	DIN 6499 (ER 40)	63	25	M 50x1,5	LH
Z091.005.R	For spring collets T133	50	23	M 40x1,5	RH
Z091.100.R	DIN 6499 (ER 25) ball bearing nut	42	20	M 32x1,5	RH/LH
Z091.101.R	DIN 6499 (ER 32) ball bearing nut	50	25	M 40x1,5	RH/LH
Z091.102.R	DIN 6499 (ER 40) ball bearing nut	63	27	M 50x1,5	RH/LH
Z091.103.R	DIN 6499 (ER 25)	42	20	M 32x1,5	RH
Z091.104.R	DIN 6499 (ER 20)	35	19	M 25x1,5	RH
Z091.105.R	DIN 6499 (ER 16)	32	17,5	M 22x1,5	RH
Z091.202.R	DIN 6388 (EOC25)	60	30	M 48x2	RH
Z091.203.R	DIN 6388 (EOC25) ball bearing nut	60	30	M 48x2	RH/LH
Z091.205.R	DIN 6388 (EOC12)	35	28	M 27x1,5	RH
Z091.301.R	ETS 32	50	22	M 40x1,5	RH
Z091.302.R	ETS 40	63	25	M 50x1,5	RH
Z091.403.R	ER 25 Type mini	35	20	M 30x1	RH
Z091.404.R	ER 20 Type mini	28	19	M 24x1	RH
Z091.405.R	ER 16 Type mini	22	18	M 19x1	RH
Z091.406.R	ER 11 Type mini	16	12	M 13x0,75	RH

WRENCHES FOR COLLET NUT "MINI"

ART. Z052

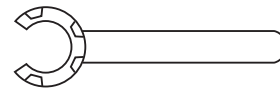

Item	Description
Z052.503.N	Wrench for collet nut ER 25 "mini" type
Z052.505.N	Wrench for collet nut ER 16 "mini" type
Z052.508.N	Wrench for collet nut ER 20 "mini" type
Z052.511.N	Wrench for collet nut ER 11 "mini" type

DUST PLUG

ART. Z051

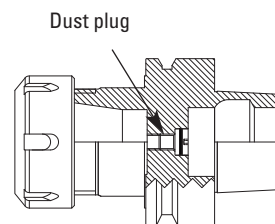
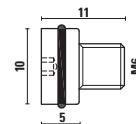

- To be used with our HSK toolholders to avoid any contamination of dust into the electrospindle.
- Inexpensive and easy to use.

Item	Description
Z051.070.N	M6x6 - hexagon head

"NO-NOISE" COLLET NUTS

ART. Z091

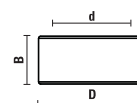

- Recommended when using router bits working at higher RPM
- Threaded nut with ground contours, remarkable reduction of noise

Item	Type	D	B	d	Rot.
Z091.501.R	DIN 6499 (ER 32)	50	23	M 40x1,5	RH
Z091.505.R	DIN 6499 (ER 16)	32	17,5	M 22x1,5	RH
Z091.522.R	DIN 6499 (EOC 25)	60	30	M 48x2	RH

You can find all spare parts in the section n. 10

RETAINING PAWLS FOR CONCENTRIC CHUCK

ART. T118

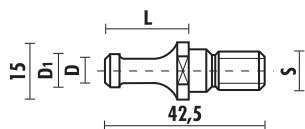

For: **Morbidelli, SCM**

Item	Type	D1	D	L	S
T118.790.R	ISO 30	8,5	6,5	22	M10

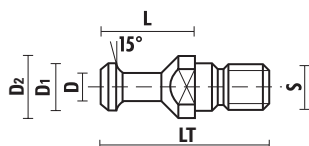

DIN 69872 for:

Anderson, Busellato, Weeke, Ima, Bulleri, Maka, Cosmec, Reichenbacher, Elte

Item	Type	D1	D2	D	L	LT	S
T118.791.R	ISO 30	13	17	9	24	44	M12
T118.893.R	ISO 40	19	23	14	26	54	M16

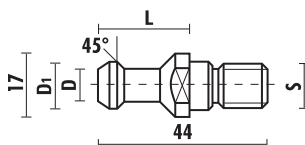

For: **Alberti, Vitap, Masterwood** (motor G. Colombo)

Item	Type	D1	D	L	S
T118.792.R	ISO 30	12,8	9	24	M12

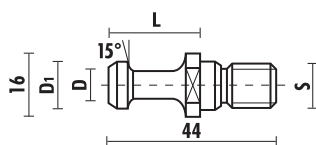

For: **Esseteam**

Item	Type	D1	D	L	S
T118.793.R	ISO 30	12	8	24	M12

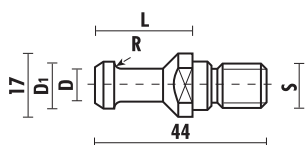

For: **CMS**

Item	Type	D1	D	L	R	S
T118.794.R	ISO 30	12,8	9	24	2,4	M12

RETAINING PAWLS FOR CONCENTRIC CHUCK

ART. T118

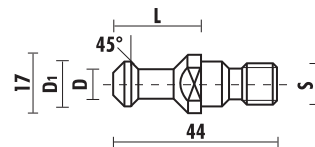

For: **Belotti**

Item	Type	D1	D	L	S
T118.795.R	ISO 30	13	9	23	M12

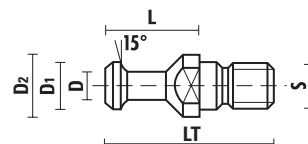

For: **Biesse** (until 9/9/92)

Item	Type	D1	D	L	S
T118.890.R	ISO 30	13	9	24	M12

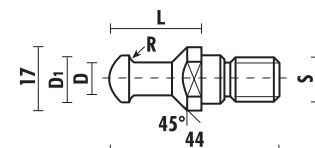

For: **Biesse** (after 9/9/92), **Masterwood, HSD spindle, Bulleri, Thermwood, Vitap, Hiteco**

Item	Type	D1	D	L	R	S
T118.891.R	ISO 30	12	8	24	3,2	M12

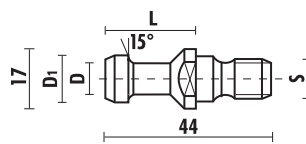

For: **Komo**

Item	Type	D1	D	L	S
T118.894.R	BT 30	13	9	24	M12

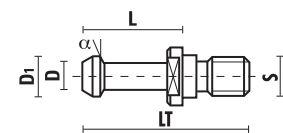

For: **BT 30 - BT 40 Shoda, BT 35 Heian**

Item	Type	D1	D	L	LT	α	S
T118.895.R	BT 30	11	7	23,5	43	30°	M12
T118.896.R	BT 35	13	8,5	28	48	45°	M12
T118.896.R030	BT 35	13	8,5	28	48	30°	M12
T118.897.R	BT 40	15	10	35	60	45°	M16

HOTBLOCK®

the new thermal shrink collet chucks are high precision collet chuck which ensure more precision having less coupling thanks to its special tight on the shank tool by thermal clamping. First, the collet tip is heated with a special heater unit, causing it to expand. The cutter shank is then inserted, and the collet is cooled to ambient temperature. This causes the collet to contract precisely around the cutter shank with a special eccentricity less than 3 micron, therefore the highest precision and stability for high performance and longer tool life.



SHRINK FIT CHUCKS HSK-63F

ART. T120



HotBlock®

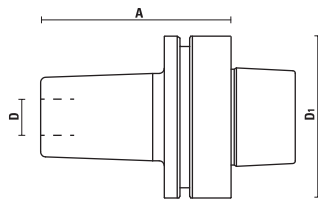

- The hollow taper shank is produced according to DIN69893
- **Concentricity** ≤ 0,003 mm
- **High precision** tool holders guaranteed by thermally induced shrink fit
- High rigidity and balance for heavy CNC working
- For HS and HW cutting tool
- **Balanced to 24.000 RPM at G 2,5**
- **Right and left-hand rotation**
- Cutting tool shank must have tolerance h6 with cylindrical shank (no flats)
- Sold complete with certificate of balancing

RPM
24.000

T139.163.N

BALLUFF
POCKET

Item	Taper	A	D1	D	Rot.
T120.564.N	HSK-63F	76	63	1/4" - (6,35 mm)	RH/LH
T120.580.N	HSK-63F	76	63	8	RH/LH
T120.595.N	HSK-63F	76	63	3/8" - (9,52 mm)	RH/LH
T120.600.N	HSK-63F	76	63	10	RH/LH
T120.620.N	HSK-63F	76	63	12	RH/LH
T120.627.N	HSK-63F	76	63	1/2" - (12,7 mm)	RH/LH
T120.660.N	HSK-63F	76	63	16	RH/LH
T120.695.N	HSK-63F	76	63	3/4" - (19,05 mm)	RH/LH
T120.700.N	HSK-63F	76	63	20	RH/LH
T120.750.N	HSK-63F	76	63	25	RH/LH

SHRINK FIT CHUCKS ISO 30

ART. T120



HotBlock®

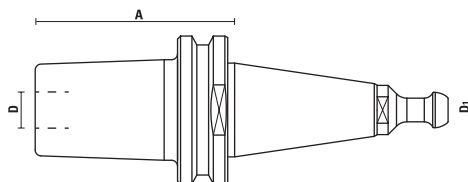

- The hollow taper shank is produced according to DIN69893
- **Concentricity** ≤ 0,003 mm
- **High precision** tool holders guaranteed by thermally induced shrink fit
- High rigidity and balance for heavy CNC working
- For HS and HW cutting tool
- **Balanced to 24.000 RPM at G 2,5**
- **Right and left-hand rotation**
- Cutting tool shank must have tolerance h6 with cylindrical shank (no flats)
- Sold complete with certificate of balancing

RPM
24.000

T139.150.N

BALLUFF
POCKET

- Retaining pawl T118.891.R for:
Biesse, Masterwood - Bulleri (for H.S.D.), **Hiteco** included
- Other Retaining pawl can be fitted on request

Item	Taper	A	D1	D	Rot.
T120.320.N	ISO 30	76	50	12	RH/LH
T120.360.N	ISO 30	76	50	16	RH/LH
T120.400.N	ISO 30	76	50	20	RH/LH

SHRINK FIT CHUCK EXTENSIONS L=150

ART. T120

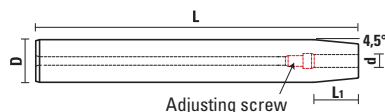

- Suitable for **working deep and hard to reach surfaces**
- To be used with heat shrink fit chucks (our item T120) or hydro chuck
- Best results when clamping HW or HS tools with h6 tool shank
- **With adjusting screw for length adjustment**

Item	D	d	L	L1	Screw
T120.012.03	12	3	150	12	M5
T120.012.04	12	4	150	16	M5
T120.016.04	16	4	150	16	M5
T120.016.06	16	6	150	26	M5
T120.020.06	20	6	150	26	M5
T120.020.08	20	8	150	26	M6
T120.020.10	20	10	150	32	M6
T120.020.12	20	12	150	37	M10
T120.025.08	25	8	150	26	M6
T120.025.10	25	10	150	32	M6
T120.025.12	25	12	150	37	M10
T120.025.16	25	16	150	40	M10

SHRINK FIT UNIT

ART. K.START.2



- **Heating time from 2 to 7 seconds**
- Provided with inductor stop rings (6 to 12) + (14 to 20) and chuck holder for HSK63F
- Heating located on the tool holder, no deterioration of the tool and tool holder
- **Self-regulated power** thanks to a microprocessor depending on parameters detected
- **Inductor rotates 180°** without disassembling
- Power supply 3x380/480V – 16A 50/60 Hz -14 kW
- Dimensions: L= 255 mm - D= 490 mm - H= 755 mm
- Weight (options excluded) 20 kgs

See this product at Section 16, page 16.18.

Item

K.START.2

COOLING UNIT WITH AIR FLOW

ART. K.FG500



- Air cooling unit for shrink fit chucks
- **Cooling time from 1,30 minute to 3 minutes**
- Provided with cooling stop rings (6 to 12) + (14 to 20) and chuck holder for HSK63F
- Compressed air supply: 4-6 bars
- Dimensions: L= 220 mm - D= 190 mm - H= 615 mm
- Weight: 5 kgs

See this product at Section 16, page 16.18.

Item

K.FG500

NB: This items cannot be sold in Germany due to commercial agreements between the producer (Elco) and their autorised dealers in these markets.

ADAPTERS FOR CIRCULAR SAWBLADES

ART. T128

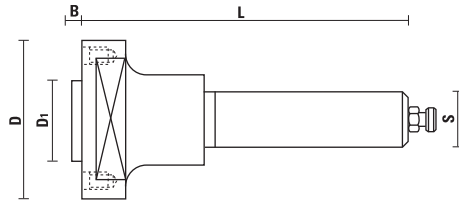

- Nr. 4 pin holes with M6/90°
- Complete with nr. 4 screws to fix the sawblade
- Recommended to use sawblades with diameters between 150 and 200 mm
- Item T128.143.R (S=16) is especially made to be mounted on aggregate heads

Item	D	D1	B	S	L	Pin holes
T128.141.R	60	22	2,5	∅20x60	90	4/4/36
T128.140.R	60	30	2,5	∅20x60	90	4/6/48
T128.143.R	60	30	2,5	∅16x50	85	4/6/48
T128.145.R	60	30	2,5	∅25x60	90	4/6/48



Z051.018.R
(T128.141.R)



Z051.014.R
(T128.140/3/5.R)



Z051.506.R

ISO 30 ADAPTERS FOR CIRCULAR SAWBLADES

ART. T128

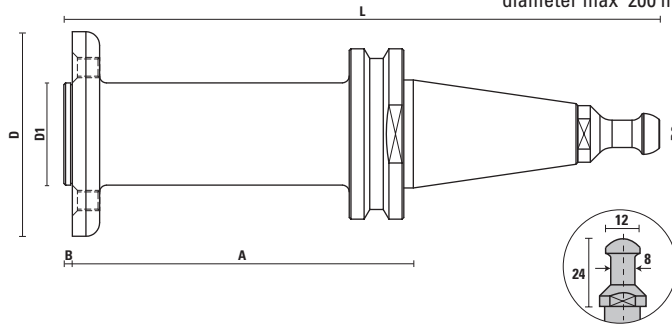

- Nr. 4 pin holes 90°
- Complete with nr. 4 screws to fix the sawblade
- For mounting saw blades with 30 mm bore
- For mounting saw blades with diameter max 200 mm

- Retaining pawl T118.891.R for: **Biesse**

Item	Taper	A	D	D1	D2	B	L
T128.150.R	ISO 30	100	60	30	50	2,5	174



Z051.014.R

HSK-63E ADAPTORS FOR LARGE DIAMETER SAWBLADES

ART. T128

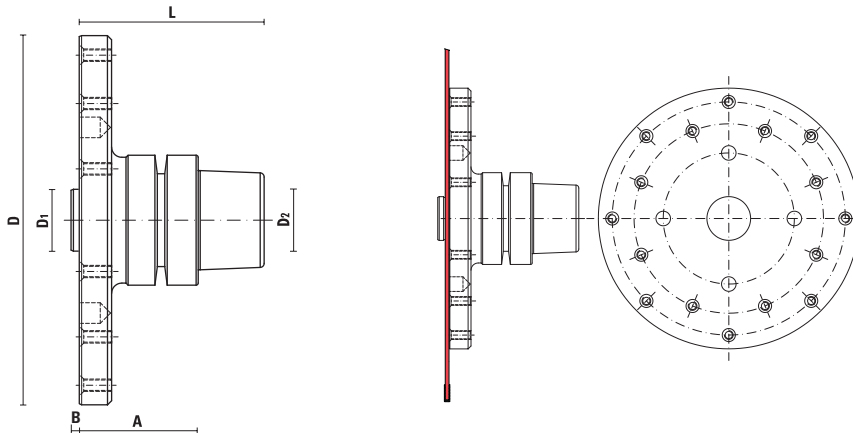

- For mounting sawblades with 30 mm bore
- For mounting sawblades with diameter up to 850 mm
- Supplied complete with 16 counterscrews M6 for mounting saw blades (part number Z051.014.N)

For: **Uniteam**

Item	Taper	A	D	D1	D2	B	L
T128.180.R	HSK-63E	57	179	30	63	4	89



Z051.014.R

HSK-63 ADAPTERS FOR CIRCULAR SAWBLADES

ART. T128

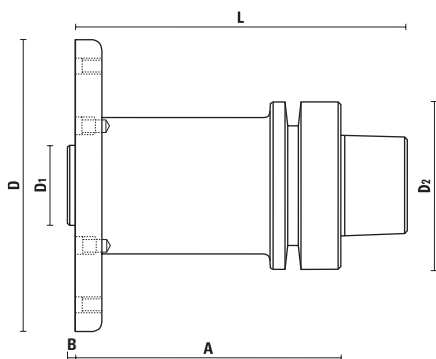

- The hollow taper shank is produced according to DIN69893
- Complete with nr. 6 screws (M6x10) for the proper assembly of sawblades with 60° at 90 mm distance
- For mounting sawblades with 30 mm bore
- **For mounting sawblades with diameter between 200 and 350 mm**



Item	Taper	A	D	D1	D2	B	L
T128.160.R	HSK-63F	40	110	30	63	2,5	65
T128.165.R	HSK-63F	100	110	30	63	2,5	125
T128.170.R	HSK-63E	40	110	30	63	2,5	72
T128.175.R	HSK-63E	100	110	30	63	2,5	132



Z051.014.R

EXAMPLE OF USE:
HSK63 adapter with mounted Saw Blade

Art. T128.160.R - T128.165.R
T128.170.R - T128.175.R

OPTIONS:
Security flange (item Z092.100.N) to secure sawblades with maximum diameter of 400 mm by changing screws.

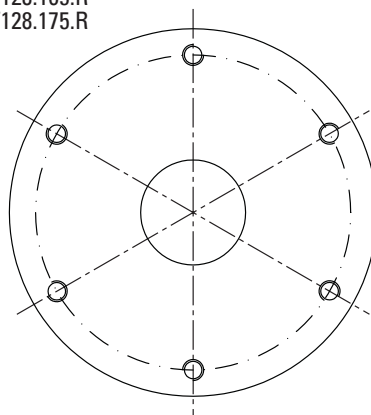
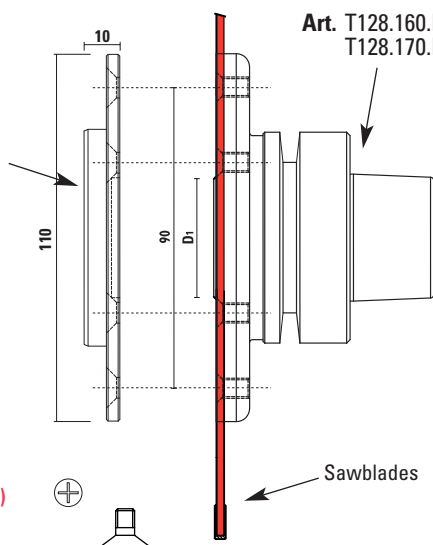

Go to page 12.30 to see the range of sawblades for these adaptors



SCREW (ART. Z051.014.R)
M6x10 countersunk flat head screw

SECURITY FLANGE FOR SAW BLADES ADAPTERS

ART. Z092



- To be used with our adapters, see items T128.160/165.R - T128.170/175.R
- **Security flange improves stability and reduces vibrations when precision cuts are needed**
- Complete with nr. 6 screws for the proper assembly of the sawblades with 60° at 90 mm distance
- **Maximum sawblades diameter of 400 mm**

ATTENTION:
Replace the adapters screws with those provided with the security flange.

Item	D	Sp
Z092.100.N	110	10



Z051.024.R

HSK-63F DRILL CHUCK FOR CNC

ART. T118

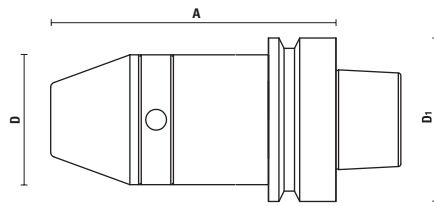

- The hollow taper shank is produced according to DIN69893
- For CNC drilling operation
- The special one-piece design guarantees best precision and greater rigidity
- Supplied with key
- Concentricity < 0,02 mm
- **Capacity from 1 mm (1/16") to 13 mm (1/2")**

**BALLUFF
POCKET**

Item	Taper	A	D	D1	Capacity	Rot.
T118.915.N	HSK-63F	110	50	63	1-13 mm	RH/LH

HOW TO CLAMP THE TOOL

- Do not clamp tapered shanks
- Minimum clamping length is 20 mm and maximum is 29 mm
- Use feed and RPM suitable for drilling

- If possible use cylindrical shanks
- If you use shank with flat, the clamping wedges are not allowed to touch the flat (see drawing)

How to clamp the tool with key

QUICK CHANGE ISO 30 TAPPING CHUCK

ART. UT118

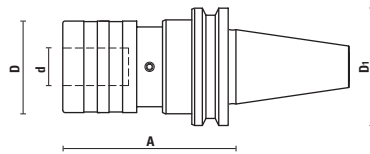

- For making threads in aluminium machining
- With **axial compensation**
- To be used with bushes for tapping with outer diameter D=19 mm DIN 352, DIN 371, DIN 376
- **Supplied without pull stud**
- For tapping operation on CNC machines

Item	Taper	A	d	D	D1
UT118.080.N	ISO 30	74	19	39	50

QUICK CHANGE HSK-63F TAPPING CHUCK

ART. UT118

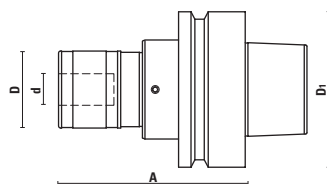

- The hollow taper shank is produced according to DIN69893
- For making threads in aluminium machining
- With **axial compensation**
- To be used with bushes for tapping with outer diameter D=19 mm DIN 352, DIN 371, DIN 376
- For tapping operation on CNC machines

**BALLUFF
POCKET**

Item	Taper	A	d	D	D1
UT118.090.N	HSK-63F	81	19	39	63

QUICK CHANGE BUSHES FOR TAPPING (DIN 371)

ART. UT100

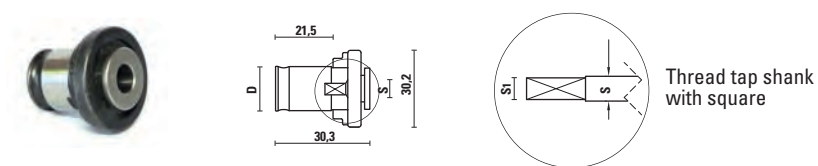

- Suitable for tapping of through holes
- **High precision**, suitable for processing aluminium
- For mounting taps ("M" series)

Item	Thread	D	S= ∅Shank	S1= □Square	Rot.
UT100.030.N	M3	19	3,5	2,7	RH/LH
UT100.035.N	M3,5	19	4	3,15	RH/LH
UT100.040.N	M4	19	4,5	3,4	RH/LH
UT100.050.N	M5	19	6	4,9	RH/LH
UT100.060.N	M6	19	6	4,9	RH/LH
UT100.080.N	M8	19	8	6,2	RH/LH
UT100.100.N	M10	19	10	8	RH/LH
UT100.120.N	M12	19	9	7	RH/LH

QUICK CHANGE BUSHES FOR TAPPING (DIN 371) WITH SAFETY CLUTCH

ART. UT105

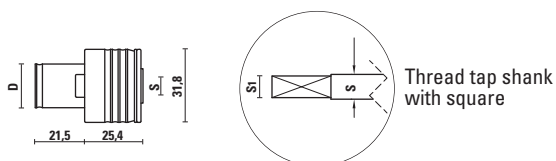

- Suitable for tapping of blind holes
- **High precision**, suitable for processing aluminium
- For mounting taps and prevents their breakage due to the safety clutch
- For mounting taps ("M" series)

Item	Thread	D	S= ∅Shank	S1= □Square	Rot.
UT105.030.N	M3	19	3,5	2,7	RH/LH
UT105.035.N	M3,5	19	4	3,15	RH/LH
UT105.040.N	M4	19	4,5	3,4	RH/LH
UT105.050.N	M5	19	6	4,9	RH/LH
UT105.060.N	M6	19	6	4,9	RH/LH
UT105.080.N	M8	19	8	6,2	RH/LH
UT105.100.N	M10	19	10	8	RH/LH
UT105.120.N	M12	19	9	7	RH/LH

EXAMPLE OF ASSEMBLY

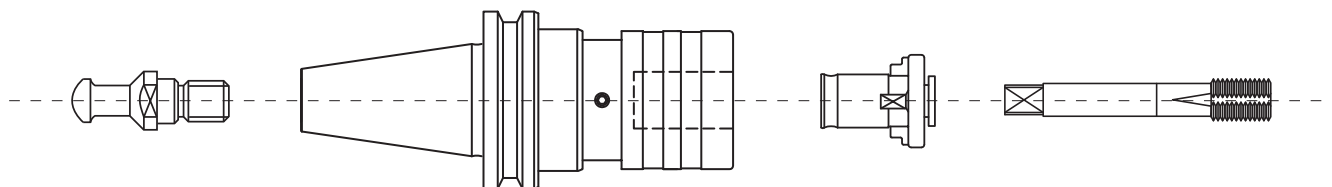

CUTTER ARBORS WITH ISO 30 TAPER

ART. T128

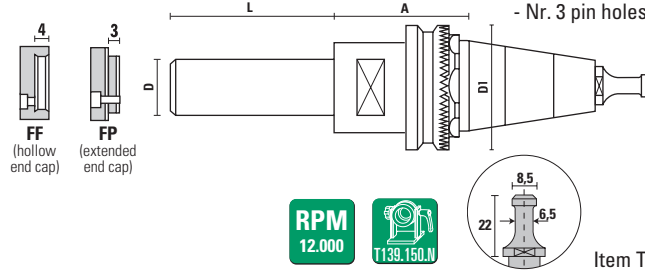

- Complete with retaining pawl page 7.39 and end cap page 10.14

- Nr. 3 pin holes to 120°

Item T118.790.R for: **Morbidelli, SCM**

Item	Taper	A	D	D ₁	L	End cap
T128.690.N	ISO 30	39	30	49	70	FF - Z092.001.R
T128.700.N	ISO 30	39	30	49	100	FF - Z092.001.R
T128.690.NM	ISO 30	39	30	49	70	FP - Z092.002.R
T128.700.NM	ISO 30	39	30	49	100	FP - Z092.002.R

Z051.016.R

CUTTER ARBORS WITH ISO 30 - ISO 40 TAPER

ART. T128

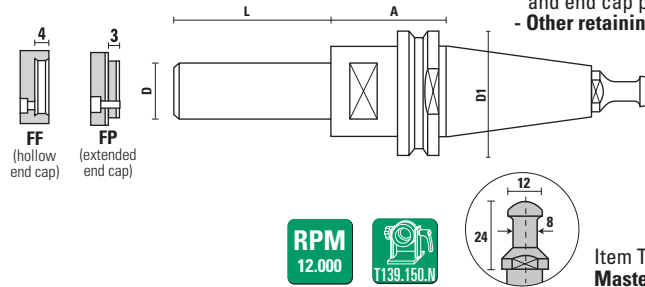

- Complete with retaining pawl page 7.39 and end cap page 10.14

- Other retaining pawl on request

Item T118.891.R for: **Biesse** (after 09/09/92), **HSD spindle, Masterwood - Bulleri, Vitap, Hiteco**

Item	Taper	A	D	D ₁	L	End cap
T128.790.N	ISO 30	35	30	50	70	FF - Z092.001.R
T128.800.N	ISO 30	35	30	50	100	FF - Z092.001.R
T128.790.NM	ISO 30	35	30	50	70	FP - Z092.002.R
T128.800.NM	ISO 30	35	30	50	100	FP - Z092.002.R
T128.800.N120	ISO 30	35	30	50	120	FF - Z092.001.R
T128.800.N120M	ISO 30	35	30	50	120	FP - Z092.002.R

Retaining pawl T118.792.R for: **Alberti, Vitap, Masterwood** (motor G. Colombo)

Item	Taper	A	D	D ₁	L	End cap
T128.791.N	ISO 30	35	30	50	70	FF - Z092.001.R
T128.801.N	ISO 30	35	30	50	100	FF - Z092.001.R
T128.791.NM	ISO 30	35	30	50	70	FP - Z092.002.R
T128.801.NM	ISO 30	35	30	50	100	FP - Z092.002.R

Retaining pawl T118.791.R (DIN 69872) for: **Busellato, Weeke, Ima, Bulleri, Maka, Cosmec, Reichenbacher, Elte**

Item	Taper	A	D	D ₁	L	End cap
T128.792.N	ISO 30	35	30	50	70	FF - Z092.001.R
T128.802.N	ISO 30	35	30	50	100	FF - Z092.001.R
T128.792.NM	ISO 30	35	30	50	70	FP - Z092.002.R
T128.802.NM	ISO 30	35	30	50	100	FP - Z092.002.R

Retaining pawl T118.893.R for: **Ima, Weeke, Maka, Reichenbacher, Stegherr**

Item	Taper	A	D	D ₁	L	End cap
T128.850.N	ISO 40	35	30	63,5	100	FF - Z092.001.R
T128.850.NM	ISO 40	35	30	63,5	100	FP - Z092.002.R

Z051.016.R

CUTTER ARBORS WITH HSK-63F TAPER

ART. T128

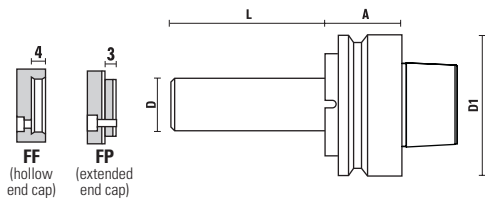

- The hollow taper shank is produced according to DIN69893
- Complete with end cap page 10.14
- Nr. 3 pin holes to 120°



Item	Taper	A	D	D1	L	End cap
T128.970.R	HSK-63F	33	30	63	70	FF - Z092.001.R
T128.970.RM	HSK-63F	33	30	63	70	FP - Z092.002.R
T128.980.R	HSK-63F	33	30	63	100	FF - Z092.001.R
T128.980.RM	HSK-63F	33	30	63	100	FP - Z092.002.R
T128.980.R060M	HSK-63F	33	30	63	60	FP - Z092.002.R
T128.980.R065M	HSK-63F	33	30	63	65	FP - Z092.002.R
T128.980.R075M	HSK-63F	33	30	63	75	FP - Z092.002.R
T128.980.R080M	HSK-63F	33	30	63	80	FP - Z092.002.R
T128.980.R085M	HSK-63F	33	30	63	85	FP - Z092.002.R
T128.980.R090M	HSK-63F	33	30	63	90	FP - Z092.002.R
T128.980.R095M	HSK-63F	33	30	63	95	FP - Z092.002.R
T128.980.R105M	HSK-63F	33	30	63	105	FP - Z092.002.R
T128.980.R110M	HSK-63F	33	30	63	110	FP - Z092.002.R
T128.980.R115M	HSK-63F	33	30	63	115	FP - Z092.002.R
T128.980.R120M	HSK-63F	33	30	63	120	FP - Z092.002.R
T128.980.R125M	HSK-63F	33	30	63	125	FP - Z092.002.R
T128.980.R130M	HSK-63F	33	30	63	130	FP - Z092.002.R
T128.980.R135M	HSK-63F	33	30	63	135	FP - Z092.002.R
T128.980.R140M	HSK-63F	33	30	63	140	FP - Z092.002.R
T128.980.R145M	HSK-63F	33	30	63	145	FP - Z092.002.R
T128.980.R150M	HSK-63F	33	30	63	150	FP - Z092.002.R
T128.980.R160M	HSK-63F	33	30	63	160	FP - Z092.002.R
T128.980.R170M	HSK-63F	33	30	63	170	FP - Z092.002.R
T128.980.R180M	HSK-63F	33	30	63	180	FP - Z092.002.R
T128.980.R200M	HSK-63F	33	30	63	200	FP - Z092.002.R
T128.980.1x125M	HSK-63F	33	1"	63	125	FP - Z092.008.R
T128.980.1,25x125M	HSK-63F	33	1-1/4"	63	125	FP - Z092.010.R
T128.980.35x100	HSK-63F	33	35	63	100	FF - Z092.003.R
T128.980.35x100M	HSK-63F	33	35	63	100	FP - Z092.004.R
T128.980.40x100	HSK-63F	33	40	63	100	FF - Z092.005.R
T128.980.40x100M	HSK-63F	33	40	63	100	FP - Z092.006.R
Item	Taper	A	D	D1	L	End cap
T128.972.R	HSK-63F	42	30	63	70	FF - Z092.001.R
T128.972.RM	HSK-63F	42	30	63	70	FP - Z092.002.R
T128.982.R	HSK-63F	42	30	63	100	FF - Z092.001.R
T128.982.RM	HSK-63F	42	30	63	100	FP - Z092.002.R
T128.982.R080	HSK-63F	42	30	63	80	FF - Z092.001.R
T128.982.R080M	HSK-63F	42	30	63	80	FP - Z092.002.R
T128.982.R125	HSK-63F	42	30	63	125	FF - Z092.001.R
T128.982.R125M	HSK-63F	42	30	63	125	FP - Z092.002.R
T128.982.1,25x125M	HSK-63F	42	1-1/4"	63	125	FP - Z092.010.R
T128.982.35x100	HSK-63F	42	35	63	100	FF - Z092.003.R
T128.982.35x100M	HSK-63F	42	35	63	100	FP - Z092.004.R



Z051.016.R

CUTTER ARBORS WITH HSK-63E TAPER

ART. T128

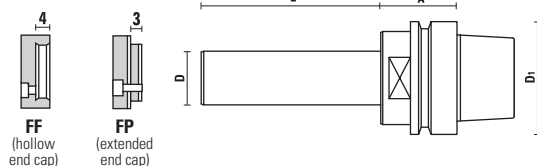

- The hollow taper shank is produced according to DIN69893
- Complete with end cap page 10.14
- Nr. 3 pin holes to 120°

RPM
12.000



BALLUFF
POCKET

Item	Taper	A	D	D1	L	End cap
T128.988.R	HSK-63E	42	30	63	100	FF - Z092.001.R
T128.988.RM	HSK-63E	42	30	63	100	FP - Z092.002.R
T128.988.R140M	HSK-63E	42	30	63	140	FP - Z092.002.R
T128.988.R160M	HSK-63E	42	30	63	160	FP - Z092.002.R
T128.988.R180M	HSK-63E	42	30	63	180	FP - Z092.002.R
T128.988.R190M	HSK-63E	42	30	63	190	FP - Z092.002.R
T128.988.R220M	HSK-63E	42	30	63	220	FP - Z092.002.R
T128.988.R230M	HSK-63E	42	30	63	230	FP - Z092.002.R
T128.988.35x100	HSK-63E	42	35	63	100	FF - Z092.003.R
T128.988.35x100M	HSK-63E	42	35	63	100	FP - Z092.004.R
T128.988.35x130M	HSK-63E	42	35	63	130	FP - Z092.004.R
T128.988.35x150M	HSK-63E	42	35	63	150	FP - Z092.004.R
T128.988.35x180M	HSK-63E	42	35	63	180	FP - Z092.004.R
T128.988.35x200M	HSK-63E	42	35	63	200	FP - Z092.004.R
T128.988.40x100	HSK-63E	42	40	63	100	FF - Z092.005.R
T128.988.40x100M	HSK-63E	42	40	63	100	FP - Z092.006.R
T128.988.40x150M	HSK-63E	42	40	63	150	FP - Z092.006.R
T128.988.40x200M	HSK-63E	42	40	63	200	FP - Z092.006.R



Z051.016.R

LIFTING FLANGE FOR CUTTER ARBORS

ART. Z092

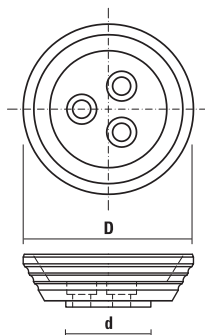

It mounts in place of the standard end cap to simplify the handling of heavy cutter stock

Item	d	D
Z092.030.N NEW	40	80

CUTTER ARBORS WITH HSK-85 TAPER

ART. T130 - T131 - T132

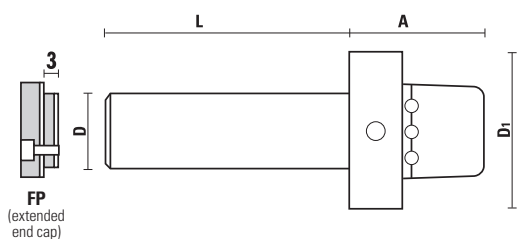

- The hollow taper shank is produced according to DIN69893
- Complete with end cap page 10.14
- Nr. 3 pin holes to 120°

RPM
12.000

T139.185.N

BALLUFF
POCKET

for: **Weinig Powerlock system**

Item	Taper	A	D	D1	L	End cap
T130.060.N	HSK-85	58	30	85	60	FP - Z092.002.R
T130.080.N	HSK-85	58	30	85	80	FP - Z092.002.R
T130.100.N	HSK-85	58	30	85	100	FP - Z092.002.R
T130.130.N	HSK-85	58	30	85	130	FP - Z092.002.R
T130.150.N	HSK-85	58	30	85	150	FP - Z092.002.R
T130.180.N	HSK-85	58	30	85	180	FP - Z092.002.R
T130.200.N	HSK-85	58	30	85	200	FP - Z092.002.R
T130.230.N	HSK-85	58	30	85	230	FP - Z092.002.R
T130.240.N	HSK-85	58	30	85	240	FP - Z092.002.R
T131.080.N	HSK-85	58	35	85	80	FP - Z092.004.R
T131.100.N	HSK-85	58	35	85	100	FP - Z092.004.R
T131.120.N	HSK-85	58	35	85	120	FP - Z092.004.R
T131.150.N	HSK-85	58	35	85	150	FP - Z092.004.R
T131.200.N	HSK-85	58	35	85	200	FP - Z092.004.R
T132.060.N	HSK-85	58	40	85	60	FP - Z092.006.R
T132.080.N	HSK-85	58	40	85	80	FP - Z092.006.R
T132.100.N	HSK-85	58	40	85	100	FP - Z092.006.R
T132.130.N	HSK-85	58	40	85	130	FP - Z092.006.R
T132.150.N	HSK-85	58	40	85	150	FP - Z092.006.R
T132.180.N	HSK-85	58	40	85	180	FP - Z092.006.R
T132.200.N	HSK-85	58	40	85	200	FP - Z092.006.R
T132.240.N	HSK-85	58	40	85	240	FP - Z092.006.R



Z051.016.R

CUTTER ARBORS WITH HSK-85S TAPER

ART. T132

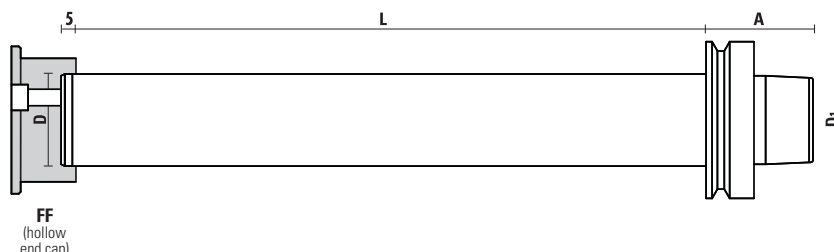

- The hollow taper shank is produced according to DIN69893
- Complete with end cap page 10.14
- Nr. 3 pin holes to 120°

RPM
12.000

T139.185.N

BALLUFF
POCKET

for: **SCM**

Item	Taper	A	D	D1	L	End cap
T132.320.NS	HSK-85S	58	50	85	320	FF - Z092.050.R



Z051.016.R

SPACERS 2-SIDES GRINDED

ART. YD300 - YD350 - YD400 - YD500 - YD600

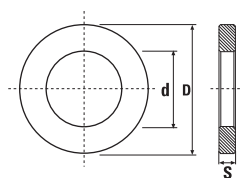

- For arbors Art. T128 - Art. T130 - Art. T131 - Art. T132
- Burnished
- Spacer rings fine-blanking processed for thickness 0,1÷1 mm (tolerance $\pm 0,02$)
- Spacer rings grinded on two sides for thickness 2÷50 mm (tolerance $\pm 0,01$)

Item	d	D	S
YD300.001	30	50	0,1
YD300.002	30	50	0,2
YD300.005	30	50	0,5
YD300.010	30	50	1
YD300.020	30	50	2
YD300.030	30	50	3
YD300.040	30	50	4
YD300.050	30	50	5
YD300.060	30	50	6
YD300.080	30	50	8
YD300.100	30	50	10
YD300.120	30	50	12
YD300.150	30	50	15
YD300.200	30	50	20
YD300.250	30	50	25
YD300.300	30	50	30
YD300.400	30	50	40
YD300.500	30	50	50
YD350.001	35	55	0,1
YD350.002	35	55	0,2
YD350.005	35	55	0,5
YD350.010	35	55	1
YD350.020	35	55	2
YD350.030	35	55	3
YD350.040	35	55	4
YD350.050	35	55	5
YD350.060	35	55	6
YD350.080	35	55	8
YD350.100	35	55	10
YD350.120	35	55	12
YD350.150	35	55	15
YD350.200	35	55	20
YD350.250	35	55	25
YD350.300	35	55	30
YD350.400	35	55	40
YD350.500	35	55	50

Item	d	D	S
YD400.001	40	60	0,1
YD400.002	40	60	0,2
YD400.005	40	60	0,5
YD400.010	40	60	1
YD400.020	40	60	2
YD400.030	40	60	3
YD400.040	40	60	4
YD400.050	40	60	5
YD400.060	40	60	6
YD400.080	40	60	8
YD400.100	40	60	10
YD400.120	40	60	12
YD400.150	40	60	15
YD400.200	40	60	20
YD400.250	40	60	25
YD400.300	40	60	30
YD400.400	40	60	40
YD400.500	40	60	50
YD500.001	50	70	0,1
YD500.002	50	70	0,2
YD500.005	50	70	0,5
YD500.010	50	70	1
YD500.020	50	70	2
YD500.030	50	70	3
YD500.040	50	70	4
YD500.050	50	70	5
YD500.060	50	70	6
YD500.080	50	70	8
YD500.100	50	70	10
YD500.120	50	70	12
YD500.150	50	70	15
YD500.200	50	70	20
YD500.250	50	70	25
YD500.300	50	70	30
YD500.400	50	70	40
YD500.500	50	70	50
YD600.001	60	80	0,1
YD600.002	60	80	0,2
YD600.005	60	80	0,5
YD600.010	60	80	1
YD600.020	60	80	2
YD600.030	60	80	3
YD600.040	60	80	4
YD600.050	60	80	5
YD600.060	60	80	6
YD600.080	60	80	8
YD600.100	60	80	10
YD600.120	60	80	12
YD600.150	60	80	15
YD600.200	60	80	20
YD600.250	60	80	25
YD600.300	60	80	30
YD600.400	60	80	40
YD600.500	60	80	50



SPACERS SET

ART. YD300 - YD350 - YD400 - YD500 - YD600

Item	d	D
YD300.990	30	50
YD350.990	35	55
YD400.990	40	60
YD500.990	50	70
YD600.990	60	80

Complete with:

nr. 4 sp. 2 mm - nr. 3 sp. 4 mm - nr. 2 sp. 5 mm
nr. 2 sp. 10 mm - nr. 1 sp. 20 mm - nr. 1 sp. 30 mm

PRECISION TEST BARS

ART. T501

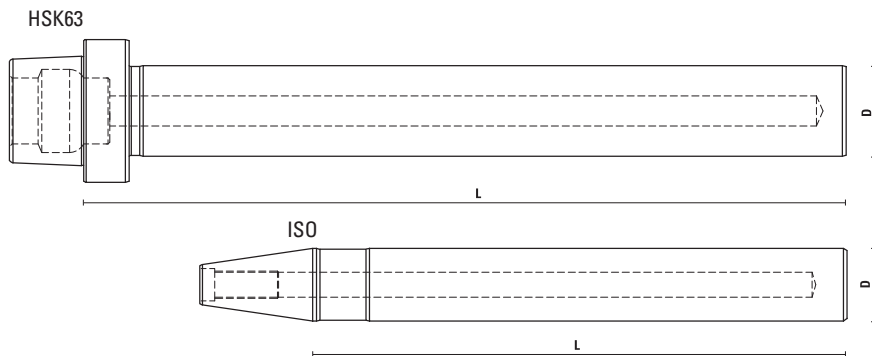

- Maximum runout error 0,003 mm/3 micron/0.0001 inch
- With certificate of calibration included
- Comes with sturdy wooden case to protect

Item	Taper	D	L
T501.080.N	ISO30	32	235
T501.090.N	HSK63F	40	335
T501.095.N	HSK63E	40	335



WHY USE THE PRECISION TEST BARS?

- Produced with accurate quality control system
- **Allows to inspect the electrospindle with extreme precision and identify any problems**
- **It is possible to check both concentricity, parallelism and alignments of the spindle of your CNC machine**
- Thanks to a regular use of our test bars, machine anomalies can be found with no risk of compromising the spindle, avoiding costly down time
- Especially lightened internally for greater efficiency.

MACHINES AND TOOLS MAINTENANCE:

Clean collets and tool holders regularly before inserting the cutting tool. Regular cleaning increases the operation safety and ensures great performance. We recommend a regular preventive maintenance of the spindle mouth, collet pocket and spring collets using the right wipers and brushes thanks to our item X137. In order to prevent the formation of corrosion and rust, tool holders and spring collets have to be treated with a protective lubricant before storing them (see our item KleinPROTECT). Any dirt, dust, oil or other contaminant left on the spindle, taper, flange or collet can cause poor TIR (runout) and premature wear. It is necessary to protect your investments in machines with a regular cleaning.

SPINDLE WIPERS

ART. T137

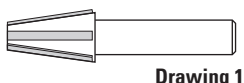

Drawing 1

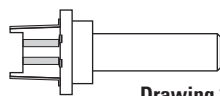

Drawing 2

- To maintain the inside of the spindle mouth clean
- Ensures extreme cleanliness of tapered spindles and it maintains the precision and prolongs the life of your expensive machines, cutting tools and toolholders
- To **avoid wrong positioning of the holders and ensure best contact between tool and tool holder for a better coupling**
- Suitable for all tool holder types
- A **proper maintenance** of the collet and the spindle with Klein® products will allow your tooling to live longer with better performance

Item	Concentric chuck	Drawing
T137.002.N	Taper 2 (MK2)	1
T137.003.N	Taper 3 (MK3)	1
T137.030.N	ISO 30/BT 30	1
T137.040.N	ISO 40/BT 40	1
T137.125.N	HSK25 A - C - E	2
T137.132.N	HSK32 A - C - E	2
T137.140.N	HSK40 A - C - E	2
T137.150.N	HSK50 A - C - E	2
T137.250.N	HSK50 B - D - F	2
T137.163.N	HSK63 A - C - E	2
T137.263.N	HSK63 B - D - F	2

COLLET WIPERS

ART. T137

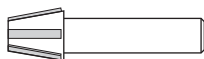

- To maintain the inside of the collet taper part clean
- To avoid wrong positioning of the collet due to resin
- For all collet types

Item	Collet type
T137.516.N	ER16
T137.520.N	ER20
T137.525.N	ER 25-ETS 25-DIN6499
T137.532.N	ER 32-ETS 32-DIN6499
T137.540.N	ER 40-ETS 40-DIN6499
T137.662.N	EOC 25-DIN 6388

BRUSHES FOR COLLET BORE

ART. T137



- To clean the collet bore
- To avoid wrong tool positioning caused by resin

Item	Collet bore
T137.906.N	3÷6
T137.911.N	6,4÷11
T137.918.N	12÷18
T137.925.N	19÷25

X137.004.N Collet brush set 3÷25



WIPE OFF KIT FOR CNC

ART. X137



- For a perfect maintenance of your CNC router or machining centres
- For cleaning boring machines and CNC router machines. Ensures **extreme cleanliness of tapered spindles and it maintains the precision and prolongs the life of your expensive machines, cutting tools and toolholders**
- Carton box
- Available for every tool holders cone and spring collets
- A complete set with:
 - Spindle wipers for every kind of tool holder (Item T137);
 - Collet wiper to avoid wrong positioning of the collet (Item T137);
 - No° 4 brushes for collet bore (Item X137)

Item	Description
X137.000.N	HSK63F/ER32 T137.263.N + T137.532.N + X137.004.N
X137.001.N	ISO30/ER32 T137.030.N + T137.532.N + X137.004.N
X137.002.N	HSK63F/DIN6388 T137.263.N + T137.662.N + X137.004.N
X137.003.N	HSK25E/ER 16 T137.125.N + T137.516.N + X137.004.N
X137.005.N	HSK63F/ER40 T137.263.N + T137.540.N + X137.004.N
X137.006.N	ISO30/ER40 T137.030.N + T137.540.N + X137.004.N
X137.010.N	HSK32E/ER25 T137.132.N + T137.525.N + X137.004.N
X137.011.N	HSK40E/ER25 T137.140.N + T137.525.N + X137.004.N
X137.012.N	HSK50E/ER32 T137.150.N + T137.532.N + X137.004.N
X137.013.N	HSK50F/ER32 T137.250.N + T137.532.N + X137.004.N

ADJUSTABLE DEMOUNT DEVICES

ART. T139

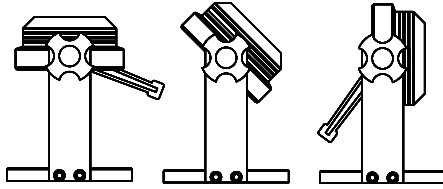

- The tool holder has to be blocked on the flange diameter which is made in special and durable steel
- **Auto-locking roller bearing design for the fastest tool changes and no slippage**
- It is adjustable from 0° to 90°
- Wide range of tightening stand/locking devices available for HSK32, HSK40, HSK50, HSK63, ISO30 and ISO40 spindles
- **Easy to be mount near the machine thanks to four holes on the basement. NB: Tightening device must be fixed before using**

Item	Collet chuck
T139.132.N	For HSK32 tool holder Ø 32 mm
T139.140.N	For HSK40 tool holder Ø 40 mm
T139.150.N	For ISO 30/HSK50 tool holder with Ø 50 mm flange
T139.157.N	For ISO 30 tool holder with Ø 57 mm flange (Thermwood machines)
T139.158.N	For ISO 30 tool holder Ø 58 (Motor ELTE/ESSETEAM)
T139.163.N	For HSK63 tool holder Ø 63
T139.164.N	For ISO 40 tool holder Ø 63,5

DEMOUNT DEVICES FOR FLANGE Ø80 - Ø85

ART. T139



- Tool holder to be blocked on the flange diameter
- **Easy to be mount near the machine thanks to four holes on the basement. NB: Tightening device must be fixed before using**
- **Auto-locking roller bearing design for the fastest tool changes and no slippage**

Item	Collet chuck
T139.180.N	For tool holder Ø 80 mm
T139.185.N	For tool holder Ø 85 mm (Weinig, SCM)

DEMOUNT DEVICES

ART. T139

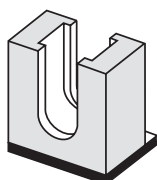

Suitable for toolholders with key seat 41 mm

Item	
T139.003.N selling out	For ISO 40 tool holder Ø 63,5

SOLID CARBIDE ROUTER BITS

Klein offers a very wide range of solid carbide router bits which can satisfy almost all the request of the market of CNC router machine.

HW SOLID CARBIDE SPIRAL CUTTER FOR PORTABLE AND CNC ROUTERS

Standard HW straight bits	<p>Straight Cut</p>	<p>Up cut spirals for an excellent finish on the bottom side of the panel pushing wood chips upward.</p>	<p>UP CUT style</p> <p>Chippings</p> <p>BEST FINISH</p>
<p>Down cut spirals for an excellent finish on the top side of the panel pushing wood chips downward</p>	<p>DOWN CUT style</p> <p>BEST FINISH</p> <p>Chippings</p>	<p>Compression spirals for an excellent finish on both sides of the panels, especially on laminates and double-sided melamine (UP & DOWN).</p>	<p>COMPRESSION spiral</p> <p>Chippings</p> <p>BEST FINISH</p> <p>Chippings</p>

NUMBER OF TEETH:

- Z=1:** allow heavy duties on soft materials and an excellent chip evacuation
- Z=2:** allow a better finish on hard materials and a good chip evacuation
- Z=3:** allow an excellent finish on all types of materials
- Z=2/Z=3 with chipbreaker:** ideal for heavy duties
- Z=3:** with semi finishing chip-braker execution

N.B.:

Increasing the number of teeth should increase also the feed speed in order to preserve the tool from burning or early wearing out.

Minimum clamping tool length	
Shank diameter S (mm)	Minimum length K (mm)
S ≤ 10	K ≥ 20
10 < S < 25	K = S x 2
S ≥ 25	K = S x 1,8

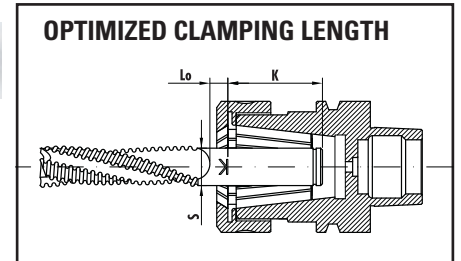
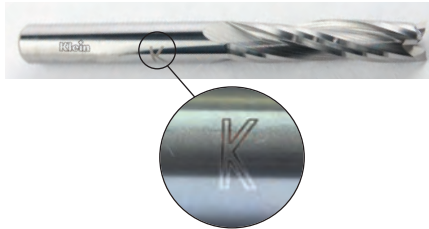

N.B.:

All **Klein** spiral router bits have technical data, dimensions and type of material marked on the shank. Moreover the sign **K** indicates the minimum clamping length according to the standard EN847-2

The following reference tables are provided just as a guide, while various other conditions must be always taken in consideration, such as the characteristics of the wood piece (humidity, veins, etc.), the machine and tooling conditions, etc.

HOW TO CHOSE THE RIGHT SOLID CARBIDE SPIRAL BIT FOR ROUTING ON A CNC MACHINE

Router Bits Klein	Woods	Softwood (Cider, Poplar, Pine, etc.)	Hardwood (Ash, Walnut, Beech, Oak, Teak, etc.)	Pressed Wood (Plywood, Blockboard)	Laminated Wood (Veneered, melamine coated panels, HPL, etc.)
T141/T151 - Z=1 - Page 7.46/7.50		XXX	XXX	X	-
T142/T152 - Z=2 - Page 7.47/7.51		XXX	XXX	X	XX
T143/T153 - Z=3 - Page 7.48/7.51		XX	XX	XXX	XXX
T144/T154 - Z=3 With chipbreaker Page 7.49/7.51-7.52		XXX	XXX	XXX	XX
T155 - Z=1+1 - Page 7.52		XX	XX	X	X
T156 - Z=2+2 - Page 7.53		X	XX	XXX	XXX
T170/T171 - Z=2 With chipbreaker Page 7.56		X	X	XX	XX

X = Satisfactory
 XX = Good
 XXX = Excellent
 - = not suggested



Technical data and images are just an indication. **SISTEMI** srl reserves the right to modify the above information at any time and without notice

REFERENCE TABLE FOR CALCULATING FEEDING RATES IN THE WOODWORKING

Reference table for calculating feeding rates (mt/min ⁻¹) at RPM 18.000					
DIAMETER	ITEM	SOFTWOOD	HARDWOOD	MDF	LAMINATED WOOD
Ø 3	T141	2,40	2,40	2,40	-
	T142	3,20	2,60	3,00	-
	T143	-	-	-	-
	T144	-	-	-	-
	T156	-	-	-	-
Ø 6	T141	3,70	3,60	3,40	-
	T142	4,00	3,70	3,90	-
	T143	-	-	-	-
	T144	-	-	-	-
	T156	-	-	-	-
Ø 8	T141	4,30	4,00	3,80	-
	T142	5,00	4,30	4,90	-
	T143	6,00	4,60	5,20	5,80
	T144	8,20	6,60	6,80	-
	T156	6,60	5,20	5,70	6,50
Ø 10	T141	4,90	4,90	3,80	-
	T142	6,20	4,60	5,40	-
	T143	7,30	5,00	6,10	6,80
	T144	9,10	6,60	7,40	-
	T156	6,70	5,10	6,00	6,60
Ø 12	T141	5,10	4,90	4,20	-
	T142	6,50	5,20	5,40	-
	T143	7,90	6,30	6,80	7,40
	T144	10,20	8,10	8,30	-
	T156	6,90	5,10	6,00	6,70
Ø 16	T141	-	-	-	-
	T142	7,70	6,10	6,90	-
	T143	9,50	7,90	8,10	9,10
	T144	11,80	9,00	9,50	-
	T156	7,30	6,00	6,30	6,80
Ø 20	T141	-	-	-	-
	T142	8,60	7,30	7,90	-
	T143	10,80	8,50	8,90	10,00
	T144	15,00	11,00	11,90	-
	T156	8,00	6,90	7,20	7,00

Technical data and images are just an indication. **SISTEMI** srl reserves the right to modify the above information at any time and without notice.

THE RECOMMENDED FEED RATES WERE CALCULATED TAKING IN CONSIDERATION THE FOLLOWING PARAMETERS:
 - **efficient machinery** in excellent conditions; - **wood piece** perfectly clamped; - **working solid material** (if not, parameters can be increased) - **wood piece dry**.

for working softwood	Good	Excellent
Single pass	T155+T141/T151	T142/T152
Roughing	T144/T154	T144/T154
Finishing	T142/T152	T143/T153

for working laminated and veneered chipboard	Good	Excellent
Single pass	T156	T156

for working hardwood	Good	Excellent
Single pass	T142/T152	T142/T152
Roughing	T144/T154	T144/T154
Finishing	T142/T152	T143/T153

for working hard plastic (nylon, corian®, acrylic)	Good	Excellent
Single pass	T141	T142
Roughing	T170	T144
Finishing	T156/T142	T156/T142

for working MDF	Good	Excellent
Single pass	T142	T145
Roughing	T170	T144
Finishing	T145	T143

Conversion chart inch/mm

Inches - Millimeters	Inches - Millimeters	Inches - Millimeters
1/32" = 0,794	1/4" = 6,35	5/8" = 15,875
1/16" = 1,588	5/16" = 7,938	3/4" = 19,050
1/8" = 3,175	3/8" = 9,525	7/8" = 22,225
3/16" = 4,762	1/2" = 12,7	1" = 25,4

KleinDIA®

DLC COATING FOR EXCELLENT PERFORMANCE AND LONGER LIFETIME



KleinDIA® is the most advantageous coating, ensuring:

- Production increase
- Better finishing
- Less maintenance
- Longer lifetime

TECHNICAL FEATURES:

- High hardness Hv0,025: 2500-3100
- Higher wear resistance (longer working time)
- Low frictional coefficient (lowered working temperature)
- Very low sticking coefficient (Better chips evacuation)
- Thickness: appr. 1 micron
- Colour: bright black



SOFTWOOD - HARDWOOD



MDF - CHIPBOARD



VENEERED AND LAMINATES



ADVANCED MATERIALS



ALUMINIUM



PLASTIC MATERIAL
SOLID SURFACE



PLASTIC COATED



PLEXIGLASS

UP TO
4/6X
TOOL LIFE

HW ROUTER BITS Z=2

ART. T110

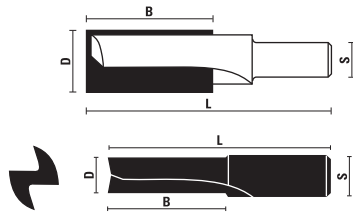

RH rotation	D	B	L	S
T110.030.R ▲	3	8	38	9,5x20
T110.040.R ▲	4	10	39	9,5x20
T110.050.R ▲	5	12	41	9,5x20
T110.060.R ▲	6	16	43	9,5x20
T110.070.R ▲	7	18	45	9,5x20
T110.080.R ▲	8	20	48	9,5x20
T110.081.R ▲	8	30	60	9,5x20
T110.090.R ▲	9	22	52	9,5x20
T110.100.R ▲	10	24	52	9,5x20
T110.101.R ▲	10	35	65	9,5x20
T110.120.R ▲	12	30	60	12x20
T110.121.R ▲	12	40	70	12x20
T110.130.R selling out	13	30	60	12x20
T110.140.R	14	40	65	12x20
T110.160.R	16	40	65	12x20
T110.180.R	18	40	70	12x20
T110.200.R	20	40	70	12x20
T110.220.R	22	40	70	12x20
T110.240.R	24	40	70	12x20
T110.250.R	25	40	70	12x20
T110.260.R selling out	26	42	70	12x20
T110.280.R selling out	28	42	70	12x20
T110.300.R selling out	30	42	70	12x20

▲ Solid carbide

VHW ROUTER BITS Z=2

ART. T112



- Solid carbide
- Indicated for plastic and acrylic material, plexiglass, polypropylene etc.
- "0" flute straight

RH rotation	D	B	L	S
T112.050.R	5	12	48	5
T112.060.R	6	14	50	6
T112.080.R	8	18	55	8
T112.100.R	10	20	58	10
T112.120.R	12	26	64	12

SOLID CARBIDE SPIRAL CUTTERS, FINISH STYLE Z=1

ART. T141

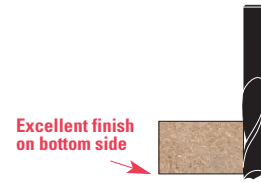
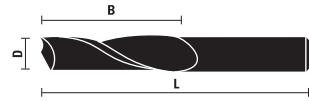

- Right-hand rotation with "UP CUT SPIRAL"
- To be used on machining centres, CNC routers and point to point machines

RH rotation	D	B	L	Z
T141.030.R	3	12	50	1
T141.040.R	4	12	50	1
T141.050.R	5	17	50	1
T141.060.R	6	17	60	1
T141.061.R	6	27	60	1
T141.064.R	6,4	28	60	1
T141.080.R	8	22	80	1
T141.081.R	8	32	80	1
T141.100.R	10	32	80	1
T141.101.R	10	42	100	1
T141.120.R	12	32	80	1
T141.121.R	12	42	100	1

Router bits with diameter from 12 mm, are produced with shank for Seeger retaining rings



SOLID CARBIDE SPIRAL CUTTERS, FINISH STYLE Z=1

ART. T141

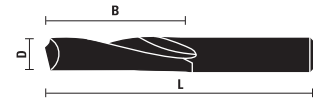

- Left-hand rotation with "DOWN CUT SPIRAL"
- To be used on machining centres, CNC routers and point to point machines

LH rotation	D	B	L	Z
T141.061.L	6	27	60	1
T141.080.L	8	22	80	1
T141.081.L	8	32	80	1
T141.100.L	10	32	100	1

SOLID CARBIDE SPIRAL CUTTERS, FINISH STYLE Z=2

ART. T142

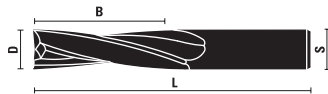

Excellent finish on bottom side



- Right-hand rotation with "UP CUT SPIRAL"
- To be used on machining centres, CNC routers and point to point machines

RH rotation	D	B	L	Z
T142.030.R	3	12	50	2
T142.032.R	1/8"	1/2"	2"	2
T142.040.R	4	12	50	2
T142.048.R	3/16"	3/4"	2"	2
T142.050.R	5	17	50	2
T142.060.R	6	17	60	2
T142.061.R	6	27	60	2
T142.064.R	1/4"	3/4"	2"	2
T142.065.R	1/4"	1-1/4"	2-1/2"	2
T142.079.R	5/16"	1"	2-1/2"	2
T142.080.R	8	22	80	2
T142.081.R	8	35	80	2
T142.095.R	3/8"	1-1/4"	3"	2
T142.100.R	10	35	80	2
T142.101.R	10	45	100	2
T142.110.R	11	35	80	2
T142.111.R	11	45	100	2
T142.120.R	12	35	80	2
T142.121.R	12	45	100	2
T142.122.R	12	55	100	2
T142.127.R	1/2"	1-1/4"	3"	2
T142.128.R	1/2"	2"	4"	2
T142.140.R	14	45	100	2
T142.141.R	14	55	100	2
T142.142.R	14	80	140	2
T142.160.R	16	45	100	2
T142.161.R	16	55	100	2
T142.162.R	16	72	120	2
T142.180.R	18	55	100	2
T142.181.R	18	72	120	2
T142.182.R	18	102	150	2
T142.200.R	20	55	100	2
T142.201.R	20	72	120	2
T142.202.R	20	102	150	2

HOW TO DETERMINE THE FEEDING SPEED RELATING TO THE DIAMETER:

- Referring to item T142 with right hand rotation (UP CUT STYLE), Z=2
- RPM 18.000

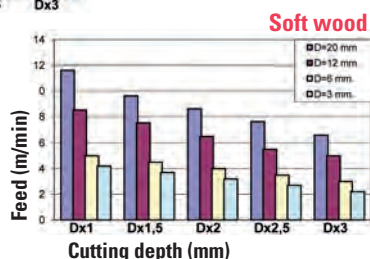
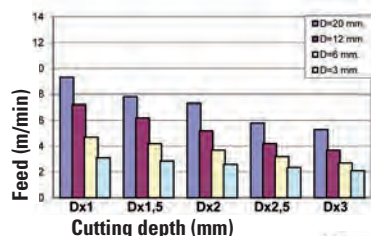

SOLID CARBIDE SPIRAL CUTTERS FINISH STYLE Z=2, Klein^{DIA} COATED

ART. T142.KD

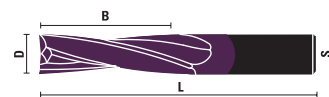

UP TO 4/6X TOOL LIFE

Excellent finish on bottom side



- Right-hand rotation with "UP CUT SPIRAL"
- Polished and coated cutting edge for improved chip evacuation and less friction for excellent performance
- Longer tool life and greater cutting quality
- For softwood and hardwood, chipboard, MDF, HF, plywood, plastic coated, mineral materials (CORIAN® ecc.)

RH rotation	D	B	L	Z
T142.030.RKD	3	12	50	2
T142.040.RKD	4	12	50	2
T142.050.RKD	5	17	50	2
T142.060.RKD	6	17	60	2
T142.061.RKD	6	27	60	2
T142.080.RKD	8	22	80	2
T142.081.RKD	8	35	80	2
T142.100.RKD	10	35	80	2
T142.101.RKD	10	45	100	2
T142.121.RKD	12	45	100	2

SOLID CARBIDE SPIRAL CUTTERS, FINISH STYLE Z=2

ART. T142

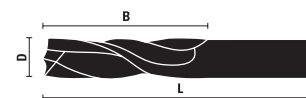

Excellent finish on panel top side



- Left-hand rotation with "DOWN CUT SPIRAL"
- To be used on machining centres, CNC routers and point to point machines

LH rotation	D	B	L	Z
T142.030.L	3	12	50	2
T142.040.L	4	12	50	2
T142.060.L	6	17	60	2
T142.081.L	8	35	80	2
T142.100.L	10	35	80	2
T142.120.L	12	35	90	2
T142.140.L	14	45	100	2
T142.160.L	16	45	100	2
T142.161.L	16	55	100	2
T142.180.L	18	55	115	2
T142.182.L	18	102	165	2
T142.200.L	20	55	120	2

Router bits with diameter from 12 mm to 20 mm, are produced with shank for Seeger retaining rings



SOLID CARBIDE SPIRAL CUTTERS, FINISH STYLE Z=3

ART. T143

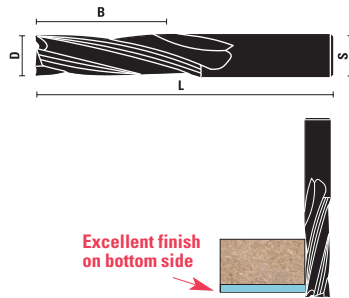

Excellent finish on bottom side

- Right-hand rotation with "UP CUT SPIRAL"
- To be used on machining centres, CNC routers and point to point machines

RH rotation	D	B	L	Z
T143.080.R	8	22	80	3
T143.081.R	8	35	80	3
T143.100.R	10	35	80	3
T143.101.R	10	45	100	3
T143.120.R	12	35	80	3
T143.121.R	12	45	100	3
T143.122.R	12	55	100	3
T143.140.R	14	45	100	3
T143.141.R	14	55	100	3
T143.160.R	16	45	100	3
T143.161.R	16	55	100	3
T143.162.R	16	72	120	3
T143.180.R	18	55	100	3
T143.181.R	18	72	120	3
T143.182.R	18	102	150	3
T143.200.R	20	55	100	3
T143.201.R	20	72	120	3
T143.202.R	20	102	150	3
T143.250.R	25	102	150	3

Router bits with diameter from 12 mm to 25 mm, are produced with shank for Seeger retaining rings



HOW TO DETERMINE THE FEEDING SPEED RELATING TO THE DIAMETER:

- Referring to item T143 with right hand rotation (UP CUT STYLE), Z=3
- RPM 18.000

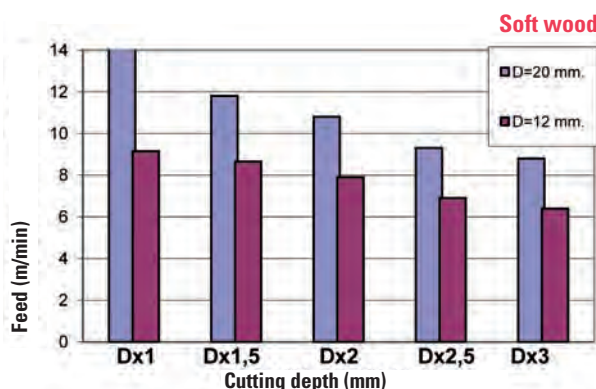
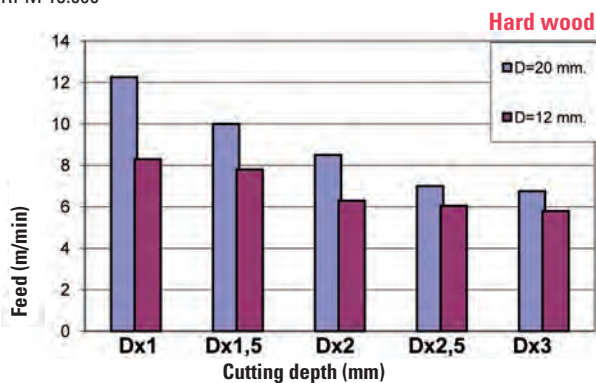

SOLID CARBIDE SPIRAL CUTTERS FINISH STYLE Z=3, KleinDIA COATED

ART. T143.KD

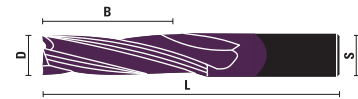

UP TO 4/6X TOOL LIFE

Excellent finish on bottom side

- Right-hand rotation with "UP CUT SPIRAL"
- Polished and coated cutting edge for improved chip evacuation and less friction for excellent performance
- Longer tool life and greater cutting quality
- For softwood and hardwood, chipboard, MDF, HF, plywood, plastic coated, mineral materials (CORIAN® ecc.)

RH rotation	D	B	L	Z
T143.081.RKD	8	35	80	3
T143.100.RKD	10	35	80	3
T143.101.RKD	10	45	100	3
T143.121.RKD	12	45	100	3

SOLID CARBIDE SPIRAL CUTTERS, FINISH STYLE Z=3

ART. T143

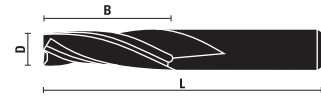

Excellent finish on panel top side

- Left-hand rotation with "DOWN CUT SPIRAL"
- To be used on machining centres, CNC routers and point to point machines

LH rotation	D	B	L	Z
T143.081.L	8	35	80	3
T143.101.L	10	45	100	3
T143.120.L	12	35	85	3
T143.160.L	16	45	100	3
T143.180.L	18	55	115	3
T143.200.L	20	55	115	3
T143.201.L	20	72	130	3

Router bits with diameter from 12 mm to 20 mm, are produced with shank for Seeger retaining rings



SOLID CARBIDE SPIRAL CUTTERS, ROUGHING STYLE Z=3

ART. T144

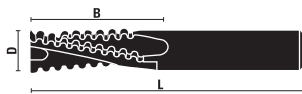

- Right-hand rotation with "UP-CUT STYLE"
- Chip-breaker execution
- To be used on machining centres, CNC routers and point to point machines
- Suitable for roughing, they guarantee a high feed rate

RH rotation	D	B	L	Z
T144.080.R	8	22	80	3
T144.081.R	8	35	80	3
T144.095.R	3/8"	1"	3"	3
T144.100.R	10	35	80	3
T144.101.R	10	45	100	3
T144.120.R	12	35	80	3
T144.121.R	12	45	100	3
T144.122.R	12	55	100	3
T144.123.R	12	42	90	3
T144.127.R	1/2"	1-1/8"	3"	3
T144.128.R	1/2"	1-5/8"	3-1/2"	3
T144.140.R	14	45	100	3
T144.141.R	14	55	100	3
T144.142.R	14	58	110	3
T144.159.R	5/8"	2"	4"	3
T144.160.R	16	45	100	3
T144.161.R	16	55	100	3
T144.162.R	16	72	120	3
T144.163.R	16	62	110	3
T144.180.R	18	55	100	3
T144.181.R	18	72	120	3
T144.182.R	18	102	150	3
T144.191.R	3/4"	2"	4"	3
T144.200.R	20	55	100	3
T144.201.R	20	72	120	3
T144.202.R	20	102	150	3
T144.250.R	25	102	155	3
T144.251.R NEW	25	130	195	3

SOLID CARBIDE SPIRAL CUTTERS ROUGHING STYLE Z=3, Klein^{DIA} COATED

ART. T144.KD

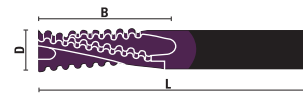

UP TO
4/6X
TOOL LIFE

- Right-hand rotation with "UP CUT SPIRAL"
- Polished and coated cutting edge for improved chip evacuation and less friction for excellent performance
- Chip-breaker execution
- Longer tool life and greater cutting quality
- Suitable for roughing, they guarantee a high feed rate

RH rotation	D	B	L	Z
T144.081.RKD	8	35	80	3
T144.100.RKD	10	35	80	3
T144.101.RKD	10	45	100	3
T144.121.RKD	12	45	100	3
T144.161.RKD	16	55	100	3

SOLID CARBIDE SPIRAL CUTTERS, ROUGHING STYLE Z=3

ART. T144

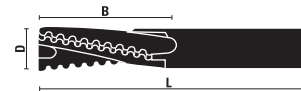

- Left-hand rotation with "DOWN-CUT STYLE"
- Chip-breaker execution
- To be used on machining centres, CNC routers and point to point machines
- Suitable for roughing, they guarantee a high feed rate

LH rotation	D	B	L	Z
T144.081.L	8	35	80	3
T144.100.L	10	35	80	3
T144.121.L	12	45	100	3
T144.122.L	12	55	105	3
T144.141.L	14	55	110	3
T144.160.L	16	45	100	3
T144.161.L	16	55	110	3
T144.162.L	16	72	125	3
T144.180.L	18	55	115	3
T144.200.L	20	55	115	3

HOW TO DETERMINE THE FEEDING SPEED RELATING TO THE DIAMETER:

- Referring to item T144 with right hand rotation (UP CUT STYLE), Z=3
- RPM 18.000

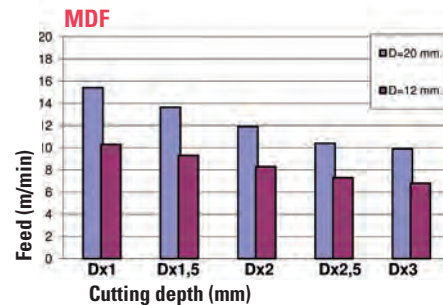
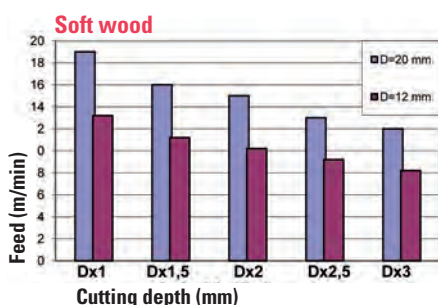
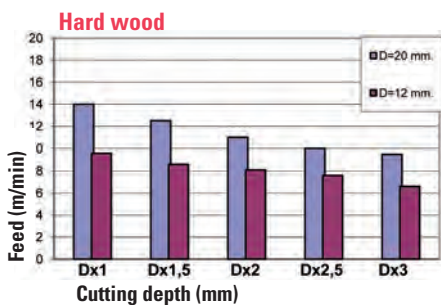

SOLID CARBIDE SPIRAL CUTTERS Z=3

ART. T146 - T147

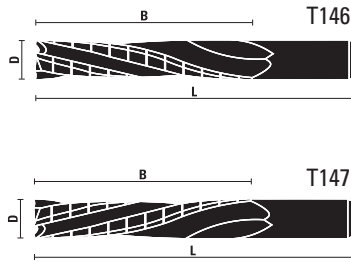

- Right-hand rotation with "UP CUT SPIRAL" (art. T146)
- Left-hand rotation with "UP CUT SPIRAL" (art. T147)
- Discontinuous cutting edge
- To be used on machining centres, CNC routers and point to point machines

RH rotation	D	B	L	Z
T146.250.R	25	140	200	3

LH rotation	D	B	L	Z
T147.250.L	25	140	200	3

SOLID CARBIDE SPIRAL CUTTERS, FINISH STYLE Z=1

ART. T151

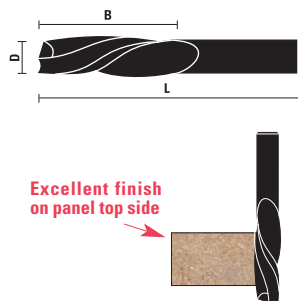

- Right-hand rotation with "DOWN CUT SPIRAL"
- To be used on machining centres, CNC routers and point to point machines

RH rotation	D	B	L	Z
T151.030.R	3	12	50	1
T151.040.R	4	12	50	1
T151.050.R	5	17	50	1
T151.060.R	6	17	70	1
T151.061.R	6	27	70	1
T151.080.R	8	22	80	1
T151.081.R	8	32	80	1
T151.100.R	10	32	80	1
T151.101.R	10	42	100	1
T151.120.R	12	32	90	1
T151.121.R	12	42	100	1
T151.122.R	12	52	110	1

SOLID CARBIDE SPIRAL CUTTERS, FINISH STYLE Z=1

ART. T151

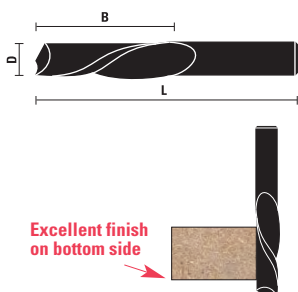

- Left-hand rotation with "UP CUT SPIRAL"
- To be used on machining centres, CNC routers and point to point machines

LH rotation	D	B	L	Z
T151.040.L	4	12	50	1
T151.061.L	6	27	60	1

SOLID CARBIDE SPIRAL CUTTERS, FINISH STYLE Z=2

ART. T152

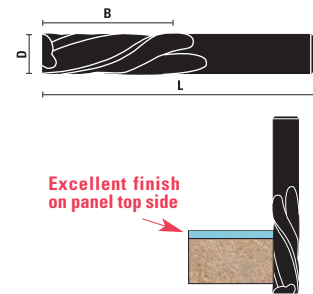

- Right-hand rotation with "DOWN CUT SPIRAL"
- To be used on machining centres, CNC routers and point to point machines

RH rotation	D	B	L	Z
T152.030.R	3	12	50	2
T152.032.R	1/8"	1/2"	2"	2
T152.040.R	4	12	50	2
T152.048.R	3/16"	3/4"	2"	2
T152.050.R	5	17	50	2
T152.060.R	6	17	70	2
T152.061.R	6	27	70	2
T152.064.R	1/4"	3/4"	2"	2
T152.065.R	1/4"	1-1/4"	2-1/2"	2
T152.079.R	5/16"	1"	2-1/2"	2
T152.080.R	8	22	80	2
T152.081.R	8	35	80	2
T152.095.R	3/8"	1-1/4"	3"	2
T152.100.R	10	35	80	2
T152.101.R	10	45	100	2
T152.110.R	11	35	80	2
T152.111.R	11	45	100	2
T152.120.R	12	35	90	2
T152.121.R	12	45	100	2
T152.122.R	12	55	110	2
T152.127.R	1/2"	1-1/4"	3"	2
T152.128.R	1/2"	2"	4"	2
T152.141.R	14	55	110	2
T152.160.R	16	45	100	2
T152.161.R	16	55	110	2
T152.180.R	18	55	115	2
T152.181.R	18	72	130	2
T152.200.R	20	55	115	2
T152.201.R	20	72	130	2

SOLID CARBIDE SPIRAL CUTTERS, FINISH STYLE Z=2

Klein^{DIA} COATED

ART. T152

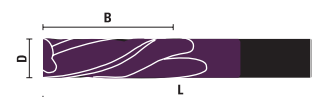

UP TO
4/6X
TOOL LIFE

Excellent finish
on panel top side

- Right-hand rotation with "DOWN CUT SPIRAL"
- Chip-breaker execution
- Longer tool life and greater cutting quality
- For softwood and hardwood, chipboard, MDF, HF, plywood, plastic coated, mineral materials (CORIAN® ecc.)

RH rotation	D	B	L	Z
T152.030.RKD	3	12	50	2
T152.040.RKD	4	12	50	2
T152.050.RKD	5	17	50	2
T152.060.RKD	6	17	70	2
T152.080.RKD	8	22	80	2
T152.101.RKD	10	45	100	2

SOLID CARBIDE SPIRAL CUTTERS, FINISH STYLE Z=2

ART. T152

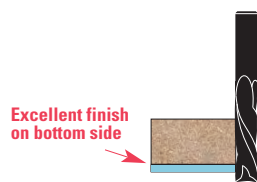
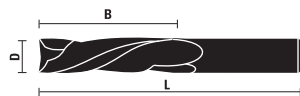

- Left-hand rotation with "UP CUT SPIRAL"

- To be used on machining centres, CNC routers and point to point machines

LH rotation	D	B	L	Z
T152.040.L	4	12	50	2
T152.060.L	6	17	60	2
T152.061.L	6	27	60	2
T152.080.L	8	22	80	2
T152.100.L	10	35	80	2
T152.120.L	12	35	80	2
T152.121.L	12	45	100	2
T152.141.L	14	55	110	2
T152.161.L	16	55	110	2
T152.181.L	18	72	120	2
T152.200.L	20	55	100	2
T152.201.L	20	72	120	2

SOLID CARBIDE SPIRAL CUTTERS, FINISH STYLE Z=3

ART. T153

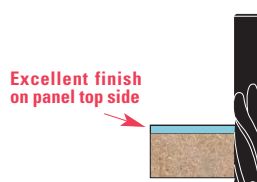
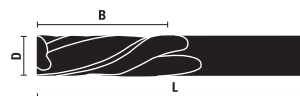

- Right-hand rotation with "DOWN CUT SPIRAL"

- To be used on machining centres, CNC routers and point to point machines

RH rotation	D	B	L	Z
T153.081.R	8	35	80	3
T153.100.R	10	35	80	3
T153.101.R	10	45	100	3
T153.120.R	12	35	85	3
T153.122.R	12	55	105	3
T153.140.R	14	45	100	3
T153.160.R	16	45	100	3
T153.161.R	16	55	110	3
T153.162.R	16	72	125	3
T153.180.R	18	55	115	3
T153.181.R	18	72	130	3
T153.200.R	20	55	115	3
T153.201.R	20	72	130	3

SOLID CARBIDE SPIRAL CUTTERS, FINISH STYLE Z=3

ART. T153

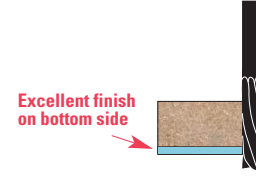
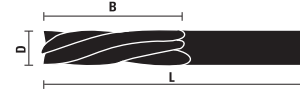

- Left-hand rotation with "UP CUT SPIRAL"

- To be used on machining centres, CNC routers and point to point machines

LH rotation	D	B	L	Z
T153.081.L	8	35	80	3
T153.100.L	10	35	80	3
T153.101.L	10	45	100	3
T153.120.L	12	35	80	3
T153.122.L	12	55	100	3
T153.140.L	14	45	100	3
T153.160.L	16	45	100	3
T153.161.L	16	55	110	3
T153.200.L	20	55	100	3
T153.201.L	20	72	120	3

SOLID CARBIDE SPIRAL CUTTERS, ROUGHING STYLE Z=3

ART. T154

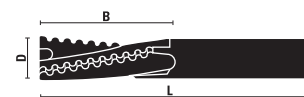

- Right-hand rotation with "DOWN CUT SPIRAL"

- Chip-breaker execution

- To be used on machining centres, CNC routers and point to point machines

- Suitable for roughing, they guarantee a high feed rate

RH rotation	D	B	L	Z
T154.080.R	8	22	80	3
T154.081.R	8	35	80	3
T154.095.R	3/8"	1"	3"	3
T154.100.R	10	35	80	3
T154.101.R	10	45	100	3
T154.120.R	12	35	83	3
T154.121.R	12	45	100	3
T154.122.R	12	55	105	3
T154.127.R	1/2"	1-1/8"	3"	3
T154.128.R	1/2"	1-5/8"	3-1/2"	3
T154.140.R	14	45	100	3
T154.159.R	5/8"	2"	4"	3
T154.160.R	16	45	110	3
T154.161.R	16	55	110	3
T154.162.R	16	72	125	3
T154.180.R	18	55	115	3
T154.181.R	18	72	130	3
T154.191.R	3/4"	2"	4"	3
T154.200.R	20	55	115	3
T154.201.R	20	72	130	3
T154.202.R	20	102	160	3

SOLID CARBIDE SPIRAL CUTTERS, ROUGHING STYLE Z=3

ART. T154

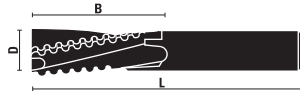

- Left-hand rotation with "UP CUT SPIRAL"
- Chip-breaker execution
- To be used on machining centres, CNC routers and point to point machines
- Suitable for roughing, they guarantee a high feed rate

LH rotation	D	B	L	Z
T154.081.L	8	35	80	3
T154.100.L	10	35	80	3
T154.120.L	12	35	80	3
T154.122.L	12	55	100	3
T154.140.L	14	45	100	3
T154.160.L	16	45	100	3
T154.161.L	16	55	110	3
T154.180.L	18	55	100	3
T154.200.L	20	55	100	3
T154.201.L	20	72	120	3
T154.250.L	25	155	220	3

SOLID CARBIDE COMPRESSION CUTTERS Z=1+1

ART. T155

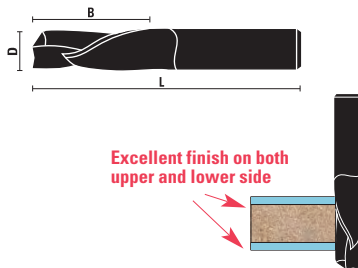

- Right-hand rotation with double flute, compression spiral
- To be used on machining centres, CNC routers and point to point machines

RH rotation	D	B	L	Z
T155.061.R	6	27	60	1+1
T155.080.R	8	22	80	1+1
T155.081.R	8	32	80	1+1
T155.100.R	10	32	80	1+1
T155.101.R	10	42	100	1+1
T155.120.R	12	42	100	1+1
T155.121.R	12	52	100	1+1
T155.127.R	12,7	32	78	1+1
T155.161.R	16	52	100	1+1

SOLID CARBIDE COMPRESSION CUTTERS Z=1+1 Klein^{DIA} COATED

ART. T155.KD

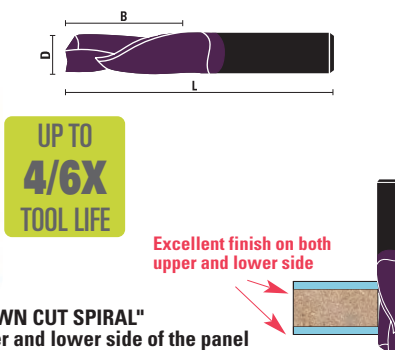

- Right-hand rotation with "DOWN CUT SPIRAL"
- Excellent finish on both upper and lower side of the panel
- Longer tool life and greater cutting quality
- To be used on machining centres, CNC routers and point to point machines
- For softwood and hardwood, chipboard, MDF, HF, double-sided melamine and laminated, plywood, plastic coated, mineral materials (CORIAN® ecc.)

RH rotation	D	B	L	Z
T155.061.RKD	6	27	60	1+1

SOLID CARBIDE COMPRESSION CUTTERS Z=1+1

ART. T155

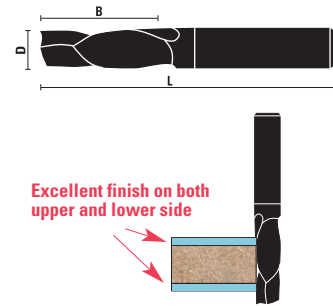

- Left-hand rotation with double flute, compression spiral
- To be used on machining centres, CNC routers and point to point machines

LH rotation	D	B	L	Z
T155.061.L	6	27	60	1+1
T155.081.L	8	32	80	1+1
T155.100.L	10	32	80	1+1
T155.120.L	12	42	100	1+1

SOLID CARBIDE COMPRESSION CUTTERS Z=2+2

ART. T156

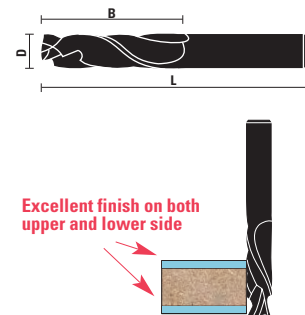

- Left-hand rotation with double flute, compression spiral
- To be used on machining centres, CNC routers and point to point machines

RH rotation	D	B	L	Z
T156.080.L	8	22	80	2+2
T156.081.L	8	32	80	2+2
T156.101.L	10	42	100	2+2
T156.120.L	12	42	100	2+2
T156.121.L	12	52	105	2+2
T156.161.L	16	52	110	2+2
T156.180.L	18	52	115	2+2
T156.200.L	20	52	115	2+2
T156.201.L	20	72	135	2+2

Router bits with diameter from 12 mm to 20 mm, are produced with shank for Seeger retaining rings



SOLID CARBIDE COMPRESSION CUTTERS Z=2+2

ART. T156

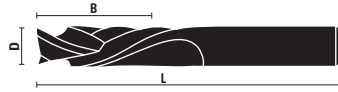

Excellent finish on both upper and lower side

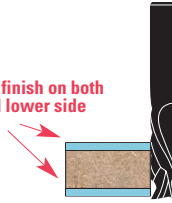

- Right-hand rotation with double flute, compression spiral
- To be used on machining centres, CNC routers and point to point machines

RH rotation	D	B	L	Z
T156.080.R	8	22	80	2+2
T156.081.R	8	32	80	2+2
T156.100.R	10	32	80	2+2
T156.101.R	10	42	100	2+2
T156.120.R	12	42	100	2+2
T156.121.R	12	52	110	2+2
T156.127.R	12,7	32	78	2+2
T156.140.R	14	42	100	2+2
T156.141.R	14	52	110	2+2
T156.160.R	16	42	100	2+2
T156.161.R	16	52	110	2+2
T156.162.R	16	72	130	2+2
T156.180.R	18	52	115	2+2
T156.181.R	18	72	135	2+2
T156.182.R	18	102	165	2+2
T156.200.R	20	52	115	2+2
T156.201.R	20	72	135	2+2

SOLID CARBIDE COMPRESSION CUTTERS Z=2+2
KleinDIA COATED

ART. T156.KD



UP TO
4/6X
TOOL LIFE

Excellent finish on both upper and lower side

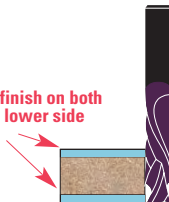

- Right-hand rotation with
- Excellent finish on both upper and lower side of the panel
- Longer tool life and greater cutting quality
- To be used on machining centres, CNC routers and point to point machines
- For softwood and hardwood, chipboard, MDF, HF, double-sided melamine and laminated, plywood, plastic coated, mineral materials (CORIAN® ecc.)

RH rotation	D	B	L	Z
T156.080.RKD	8	22	80	2+2

HOW TO DETERMINE THE FEEDING SPEED RELATING TO THE DIAMETER:

- Referring to item T156 with double flute, compression spiral, Z=2+2.
- RPM 18.000

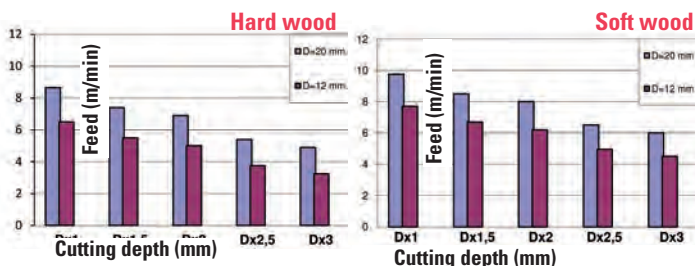

SOLID CARBIDE MORTISE COMPRESSION Z=2+2

ART. T156.M

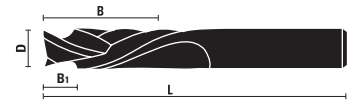

Excellent finish on both upper and lower side

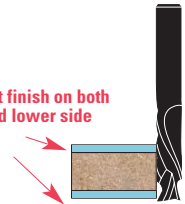

- Right-hand rotation
- Excellent finish on both upper and lower side of the panel
- These tools have a shorter up-cut section compared to standard compression bits. They are suitable for mortising, grooving, routing and dado
- For softwood and hardwood, chipboard, MDF, HF, double-sided melamine and laminated, plywood, plastic coated, mineral materials (CORIAN® ecc.)
- To be used on machining centres, CNC routers and point to point machines

RH rotation	D	B	B1	L	S
T156.095.RM	3/8"	7/8"	0,200" (5 mm)	3"	3/8"
T156.096.RM	3/8"	1-1/4"	0,200" (5 mm)	3"	3/8"
T156.125.RM	12	25	0,200" (5 mm)	80	12
T156.127.RM	1/2"	7/8"	0,200" (5 mm)	3"	1/2"
T156.128.RM	1/2"	1-1/4"	0,200" (5 mm)	3"	1/2"
T156.129.RM	1/2"	1-5/8"	0,200" (5 mm)	3-1/2"	1/2"

SOLID CARBIDE MORTISE COMPRESSION Z=2+2
KleinDIA COATED

ART. T156.MKD



UP TO
4/6X
TOOL LIFE

Excellent finish on both upper and lower side

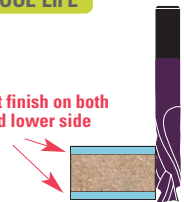
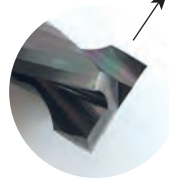

- Right-hand rotation with
- Excellent finish on both upper and lower side of the panel
- Longer tool life and greater cutting quality
- To be used on machining centres, CNC routers and point to point machines
- For softwood and hardwood, chipboard, MDF, HF, double-sided melamine and laminated, plywood, plastic coated, mineral materials (CORIAN® ecc.)

RH rotation	D	B	B1	L
T156.095.RMKD	3/8"	7/8"	0,200" (5 mm)	3"
T156.096.RMKD	3/8"	1-1/4"	0,200" (5 mm)	3"
T156.125.RMKD	12	25	0,200" (5 mm)	80
T156.127.RMKD	1/2"	7/8"	0,200" (5 mm)	3"
T156.128.RMKD	1/2"	1-1/4"	0,200" (5 mm)	3"

SOLID CARBIDE COMPRESSION CUTTERS Z=3+3

ART. T356

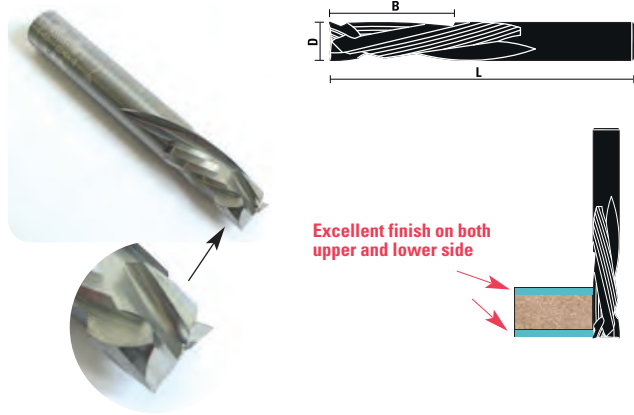

- Right-hand rotation
- To be used on machining centres, CNC routers and point to point machines
- Excellent finish on both upper and lower side of the panel
- For softwood and hardwood, chipboard, MDF, HF, plywood, plastic coated, mineral materials (CORIAN® ecc.)

RH rotation	D	B	L	Z
T356.080.R	8	22	70	3+3
T356.100.R	10	22	70	3+3
T356.101.R	10	32	70	3+3
T356.120.R	12	32	80	3+3
T356.121.R	12	42	100	3+3
T356.160.R	16	42	100	3+3
T356.161.R	16	52	100	3+3

SOLID CARBIDE COMPRESSION CUTTERS Z=3+3
Klein^{DIA} COATED

ART. T356.KD



- Right-hand rotation with
- Excellent finish on both upper and lower side of the panel
- Longer tool life and greater cutting quality
- To be used on machining centres, CNC routers and point to point machines
- For softwood and hardwood, chipboard, MDF, HF, double-sided melamine and laminated, plywood, plastic coated, mineral materials (CORIAN® ecc.)

RH rotation	D	B	L	Z
T356.120.RKD	12	32	80	3+3
T356.121.RKD	12	42	100	3+3

SOLID CARBIDE MORTISE COMPRESSION Z=3+3

ART. T356.M

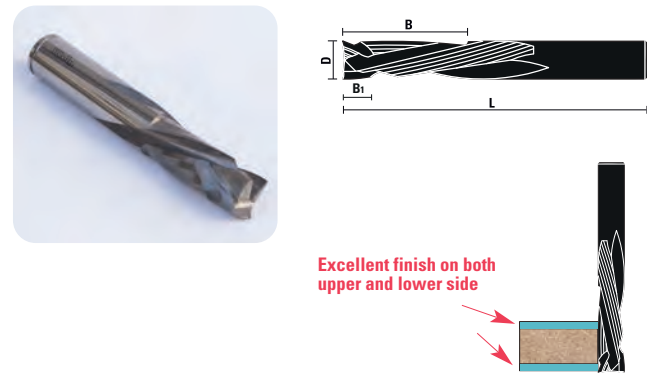

- Right-hand rotation
- Excellent finish on both upper and lower side of the panel
- These tools have a shorter up-cut section compared to standard compression bits. They are suitable for mortising, grooving, routing and dado
- For softwood and hardwood, chipboard, MDF, HF, double-sided melamine and laminated, plywood, plastic coated, mineral materials (CORIAN® ecc.)
- To be used on machining centres, CNC routers and point to point machines

RH rotation	D	B	B1	L	Z
T356.095.RM	3/8"	7/8"	0,200" (5 mm)	3"	3/8"
T356.096.RM	3/8"	1-1/4"	0,200" (5 mm)	3"	3/8"
T356.127.RM	1/2"	7/8"	0,200" (5 mm)	3"	1/2"
T356.128.RM	1/2"	1-1/4"	0,200" (5 mm)	3"	1/2"

SOLID CARBIDE MORTISE COMPRESSION Z=3+3
Klein^{DIA} COATED

ART. T356.MKD

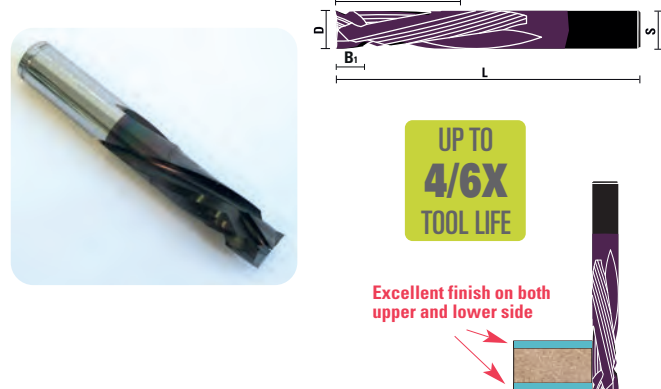

- Right-hand rotation with
- Excellent finish on both upper and lower side of the panel
- Longer tool life and greater cutting quality
- These tools have a shorter up-cut section compared to standard compression bits. They are suitable for mortising, grooving, routing and dado
- To be used on machining centres, CNC routers and point to point machines
- For softwood and hardwood, chipboard, MDF, HF, double-sided melamine and laminated, plywood, plastic coated, mineral materials (CORIAN® ecc.)

RH rotation	D	B	B1	L
T356.095.RMKD	3/8"	7/8"	0,200" (5 mm)	3"
T356.096.RMKD	3/8"	1-1/4"	0,200" (5 mm)	3"
T356.127.RMKD	1/2"	7/8"	0,200" (5 mm)	3"
T356.128.RMKD	1/2"	1-1/4"	0,200" (5 mm)	3"

SOLID CARBIDE SPIRAL CUTTERS FOR LOCK-CASE Z=2 - Z=3

ART. T157

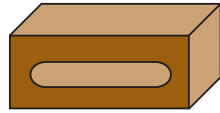
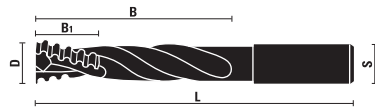

- Right-hand rotation with "UP CUT SPIRAL"
- Chip-breaker execution
- For locks and slot mortising

RH rotation	D	B1	B	L	S	Z
T157.140.R	14	20	95	155	14x45	2
T157.141.R	14	45	95	150	14x45	3
T157.160.R	16	25	115	175	16x45	2
T157.161.R	16	45	95	140	16x45	2
T157.162.R	16	50	100	150	16x45	3
T157.180.R	18	25	115	175	18x45	2
T157.181.R	18	50	100	150	18x45	3

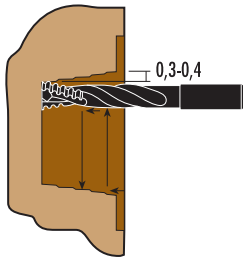

USE EXAMPLE

- Z=2/Z=3
- D= 14÷18 mm: RPM 12.000-20.000
- Stepwise processing 0,3-0,4 mm
- Can work deeply and have excellent chip evacuation

Router bits with diameter from 14 mm to 18 mm, are produced with shank for Seeger retaining rings



SOLID CARBIDE SPIRAL CUTTERS FOR LOCK-CASE Z=3, KleinDIA COATED

ART. T357.KD

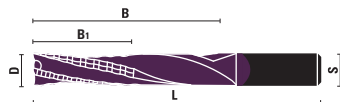

UP TO
4/6X
TOOL LIFE

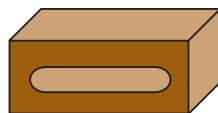

- Right-hand rotation with "UP CUT SPIRAL"
- Semifinished chip-breaker execution (roughing and finishing)
- For locks and slot mortising
- Polished and coated cutting edge for improved chip evacuation and less friction for excellent performance
- To be used on machining centres, CNC routers and point to point machines
- For softwood and hardwood, chipboard, MDF, HF, plywood, plastic coated, mineral materials (CORIAN® ecc.)

RH rotation	D	B1	B	L	S	Z
T357.162.RKD	16	45	100	150	16x45	3

SOLID CARBIDE SPIRAL CUTTERS Z=3 FOR LOCKS

ART. T177 - T178

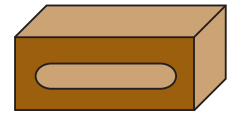
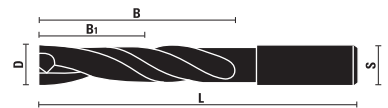

- Without chip-breaker

- For locks and slot mortising
- T177.160.R right rotation and right hand twist (positive/up cut style)
- T177.160.L left rotation and left hand twist (positive/up cut style)
- T178.160.R right rotation and left hand twist (negative/down cut style)

RH rotation	LH rotation	D	B1	B	L	S	Z
T177.160.R	T177.160.L	16	50	100	150	16x45	3
T178.160.R		16	50	100	150	16x45	3

Router bits with diameter from 16 mm, are produced with shank for Seeger retaining rings



SOLID CARBIDE SPIRAL CUTTERS Z=2

ART. T158

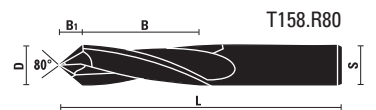
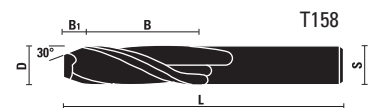

- Right-hand rotation with "UP CUT SPIRAL"

- For spy holes
- For boring and routing

RH rotation	D	B1	B	L	S	Z
T158.140.R	14	8	42	100	14	2
T158.160.R	16	9	52	120	16	2
T158.180.R	18	10	52	120	18	2
T158.200.R	20	11	52	120	20	2

T158.080.R80	8	4,8	38	80	8	2
T158.100.R80	10	6	46	100	10	2
T158.120.R80	12	7,2	50	110	12	2
T158.160.R80	16	9,6	52	120	16	2

Router bits with diameter from 12 mm to 20 mm, are produced with shank for Seeger retaining rings



SOLID CARBIDE SPIRAL CUTTERS Z=2

ART. T159

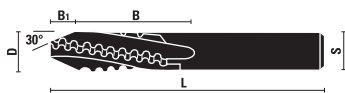

- Right-hand rotation with "UP CUT SPIRAL"
- Chip-breaker execution
- For spyholes on doors
- Through holes cutting

RH rotation	D	B1	B	L	S	Z
T159.160.R	16	9	52	120	16	2
T159.200.R	20	11	52	120	20	2

Router bits with diameter from 16 mm to 20 mm, are produced with shank for Seeger retaining rings



SOLID CARBIDE SPIRAL CUTTERS, UPCUT FINISH STYLE Z=2

ART. T160



- Can also be used on portable routers
- Right-hand rotation with "UP CUT SPIRAL"

RH rotation	D	B	L	S	Z
T160.030.R	3	12	60	6	2
T160.035.R	3,5	14	60	6	2
T160.040.R	4	14	60	6	2
T160.045.R	4,5	16	60	6	2
T160.050.R	5	17	60	6	2

SOLID CARBIDE SPIRAL CUTTERS, DOWNCUT FINISH STYLE Z=2

ART. T161

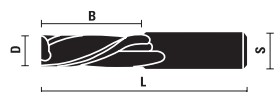

- Can also be used on portable routers
- Right-hand rotation with "DOWN CUT SPIRAL"

Rotaz. DX	D	B	L	S	Z
T161.030.R	3	12	60	6	2
T161.035.R	3,5	14	60	6	2
T161.040.R	4	14	60	6	2
T161.045.R	4,5	16	60	6	2
T161.050.R	5	17	60	6	2

SOLID CARBIDE SPIRAL CUTTERS, UPCUT FINISH STYLE Z=2

ART. T162

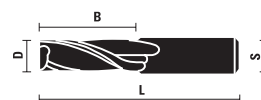

- Can also be used on portable routers
- Right-hand rotation with "UP CUT SPIRAL"

RH rotation	D	B	L	S	Z
T162.030.R	3	12	60	8	2
T162.040.R	4	14	60	8	2
T162.050.R	5	17	60	8	2
T162.060.R	6	22	70	8	2
T162.070.R	7	32	80	8	2

SOLID CARBIDE SPIRAL CUTTERS, DOWNCUT FINISH STYLE Z=2

ART. T163

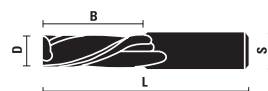

- Can also be used on portable routers
- Right-hand rotation with "DOWN CUT SPIRAL"

RH rotation	D	B	L	S	Z
T163.030.R	3	12	60	8	2
T163.040.R	4	14	60	8	2
T163.050.R	5	17	60	8	2
T163.060.R	6	22	70	8	2
T163.070.R	7	32	80	8	2

SOLID CARBIDE SPIRAL CUTTERS, FINISH STYLE Z=2

ART. T164

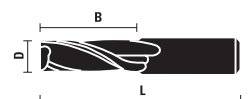

- Can also be used on portable routers
- Right-hand rotation with "UP CUT SPIRAL"

RH rotation	D	B	L	S	Z
T164.032.R	1/8"	1/2"	2"	1/4"	2
T164.048.R	3/16"	3/4"	2"	1/4"	2

SOLID CARBIDE COMPRESSION CUTTERS Z=2+2 WITH DOUBLE BALL BEARING

ART. T166

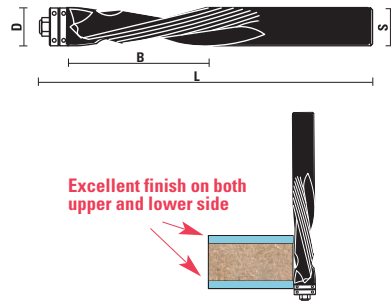

- Right-hand rotation with double flute compression spiral (UP & DOWN). The bottom part is up-cut while the upper part is down cut, ensuring excellent finish on both sides of the panel.
- Double ball bearings guide for greater precision of trimming
- Special spiral geometry which provides better chip evacuation and smoother cuts on laminate panels.

RH rotation	D	B	L	Z
T166.080.R NEW	8	36	95	2+2
T166.120.R NEW	12	51	110	2+2



SOLID CARBIDE FLUSH TRIM BITS WITH DOUBLE BALL BEARINGS Z=2

ART. T168

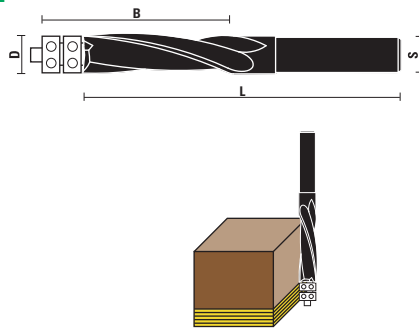

- Right-hand rotation with "UP CUT SPIRAL"
- Double ball bearings guide for **greater precision of trimming**
- Special spiral geometry which provides **better chip evacuation and smoother cuts** compared to standard flush trim bits
- For natural wood, pressed wood, veneered, laminate and melamine

RH rotation	D	B	L	S	Z
T168.127.R	12,7 (1/2")	51	125	12	2



SOLID CARBIDE SPIRAL CUTTERS "LAMELLO" Klein^{DIA} COATED

ART. T169.KD

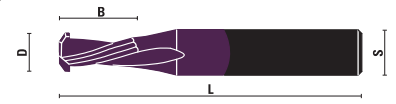
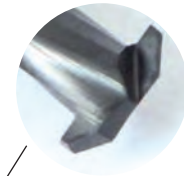

UP TO
4/6X
TOOL LIFE

- Suitable for making the groove for **Lamello P-System** with CNC router
- RH rotation
- Polished and coated cutting edge for improved chip evacuation and less friction for excellent performance
- **Longer tool life and greater cutting quality**

Item	D	B	L	S	Z
T169.098.RKD	9,8	23	80	12	2



SOLID CARBIDE SPIRAL CUTTERS, ROUGHING STYLE Z=2

ART. T170

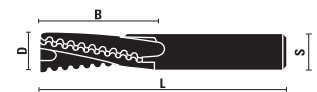

- Right-hand rotation with "UP CUT SPIRAL"
- **Chip-breaker** execution
- Z= 2 for the best chip removal

RH rotation	D	B	L	S	Z
T170.080.R	8	35	80	8	2
T170.100.R	10	35	80	10	2
T170.120.R	12	35	80	12	2
T170.121.R	12	45	90	12	2

Router bits with diameter from 12 mm, are produced with shank for Seeger retaining rings



SOLID CARBIDE SPIRAL CUTTERS, ROUGHING STYLE Z=2

ART. T171

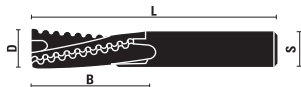

- Right-hand rotation with "DOWN CUT SPIRAL"
- Chip-breaker execution
- Z= 2 for the best chip removal

RH rotation	D	B	L	S	Z
T171.080.R	8	35	80	8	2
T171.100.R	10	35	80	10	2
T171.120.R	12	35	80	12	2

Router bits with diameter from 12 mm, are produced with shank for Seeger retaining rings



SOLID CARBIDE TAPERED BALL NOSE SPIRAL BITS Z=3

ART. T173



- Right-hand rotation with "UP CUT SPIRAL"
- Specially designed for smooth 2D and 3D carving in plastic, aluminium and wood
- Use on CNC and high speed machines

RH rotation	D	B	L	R	S
T173.008.R	1/32"	1"	3"	1/64"	1/4"
T173.009.R	0,8	25	70	0,4	6
T173.016.R	1/16"	1"	3"	1/32"	1/4"
T173.017.R	1,6	25	70	0,8	6
T173.018.R	1,6	30	80	0,8	8
T173.031.R	1/8"	1"	3"	1/16"	1/4"
T173.032.R	1/8"	2-1/2"	4"	1/16"	1/2"
T173.033.R	3,17	30	70	1,59	6
T173.034.R	3,17	50	90	1,59	8
T173.064.R	1/4"	2"	4"	1/8"	1/2"

SOLID CARBIDE SPIRAL CUTTERS RADIUS STYLE Z=2

ART. T175

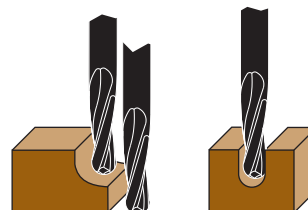

- Suitable for working plastic materials
- Right-hand rotation with "UP CUT SPIRAL"

RH rotation	D	R	B	L	S	Z
T175.030.R	3	1,5	12	50	3	2
T175.040.R	4	2	12	50	4	2
T175.060.R	6	3	22	60	6	2
T175.080.R	8	4	22	80	8	2
T175.100.R	10	5	35	80	10	2
T175.120.R	12	6	35	80	12	2
T175.160.R	16	8	55	100	16	2
T175.180.R	18	9	55	110	18	2
T175.200.R	20	10	55	110	20	2



- Perfect bit for 2D and 3D carving, deep profiling, dimensional signage, model-makers, modeling and pattern for cabinetry, sign making, furniture making

- Also known as straight ballnose router bits with straight angle and radius on top.

HS ROUTER BITS FOR "HUNDEGGER" MACHINES

ART. T244

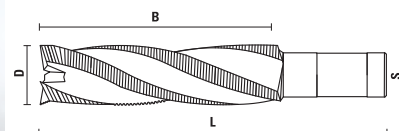

- Chip-breaker execution
- For machining lamellar beams

RH rotation	D	B	L	S	Z
T244.400.R	40	165	235	30	3
T244.500.R	50	215	295	30	3

**SOLID CARBIDE SPIRAL ROUTER BITS
FINISH/ROUGHING STYLE KleinDIA COATED**

ART. T344.KD

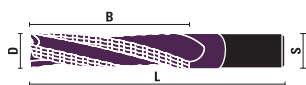

UP TO
4/6X
TOOL LIFE

Excellent finish
on bottom side



- Right-hand rotation with "UP CUT SPIRAL"
- To be used on machining centres, CNC routers and point to point machines
- Semi-finished chip-breaker execution
- For **softwood and hardwood, chipboard, MDF, HF, plywood, plastic coated, mineral materials (CORIAN® ecc.)**

RH rotation	D	B	L	Z
T344.080.RKD	8	30	80	2
T344.100.RKD	10	35	80	2
T344.120.RKD	12	35	80	3
T344.121.RKD	12	45	90	3
T344.140.RKD	14	55	110	3
T344.160.RKD	16	55	110	3
T344.161.RKD	16	75	130	3
T344.200.RKD	20	55	110	3
T344.201.RKD	20	75	130	3

**HOW TO DETERMINE THE FEEDING SPEED
RELATING TO THE DIAMETER:**

- Referring to item T344RKD with right hand rotation (UP CUT STYLE), Z=2/3
- Referring to item T354RKD with right hand rotation (DOWN CUT STYLE), Z=2/3
- Referring to item T354LKD with left hand rotation (UP CUT STYLE), Z=2/3
- RPM 18.000

Soft wood

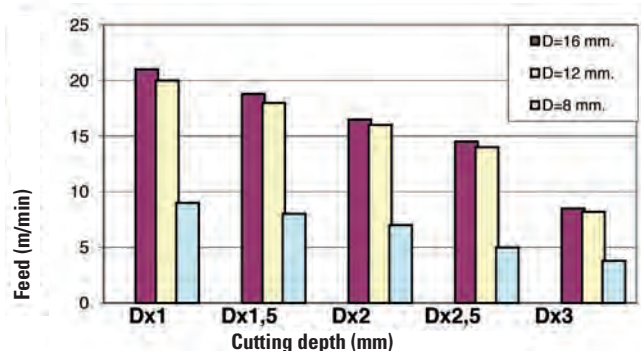

Hard wood

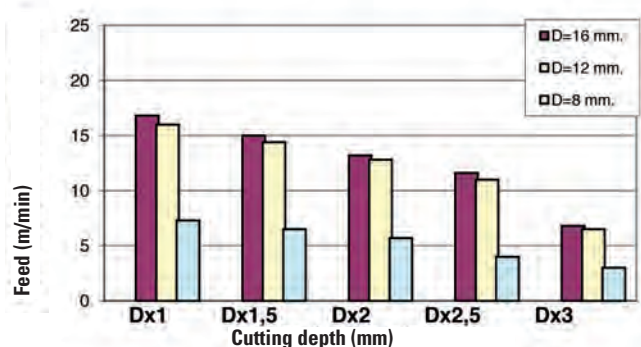

**SOLID CARBIDE SPIRAL ROUTER BITS
FINISH/ROUGHING STYLE KleinDIA COATED**

ART. T354.KD

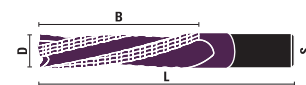

UP TO
4/6X
TOOL LIFE

Excellent finish
on panel top side



- Right-hand rotation with "DOWN CUT SPIRAL"
- To be used on machining centres, CNC routers and point to point machines
- Semi-finished chip-breaker execution
- For **softwood and hardwood, chipboard, MDF, HF, plywood, plastic coated, mineral materials (CORIAN® ecc.)**

RH rotation	D	B	L	Z
T354.100.RKD	10	35	80	2
T354.120.RKD	12	35	80	3
T354.160.RKD	16	55	110	3
T354.161.RKD	16	75	130	3
T354.200.RKD	20	55	110	3

**SOLID CARBIDE SPIRAL ROUTER BITS
FINISH/ROUGHING STYLE KleinDIA COATED**

ART. T354.KD



UP TO
4/6X
TOOL LIFE

Excellent finish
on bottom side



- Left-hand rotation with "UP CUT SPIRAL"
- To be used on machining centres, CNC routers and point to point machines
- Semi-finished chip-breaker execution
- For **softwood and hardwood, chipboard, MDF, HF, plywood, plastic coated, mineral materials (CORIAN® ecc.)**

LH rotation	D	B	L	Z
T354.100.LKD	10	35	80	2
T354.120.LKD	12	35	80	3
T354.160.LKD	16	55	110	3
T354.161.LKD	16	75	130	3
T354.200.LKD	20	55	110	3

Router bits with diameter from 12 mm, are produced with shank for Seeger retaining rings



TOOL KIT FOR CNC ROUTERS

ART. X118

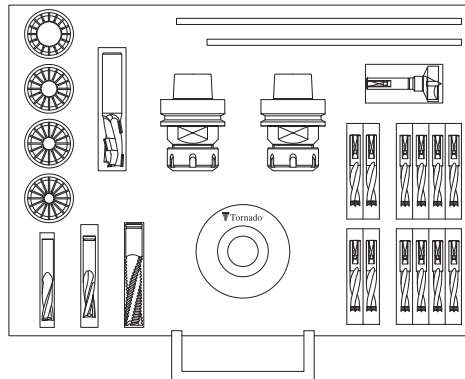

HSK63F for ER 32 spring collets

Item

X118.001.N

Complete with:

T118.976.R - nr. 2
Collet chucks HSK63F for ER 32

T119.080.R - nr. 1 - D=8
T119.120.R - nr. 1 - D=12
T119.160.R - nr. 1 - D=16
T119.200.R - nr. 1 - D=20
Spring collet - ER 32 - DIN 6499

T144.161.R - nr. 1 - D=16
Solid carbide spiral cutters, roughing style Z=3

T142.081.R - nr. 1 - D=8
T142.120.R - nr. 1 - D=12
Solid carbide spiral cutters, finish style Z=2

X502.203.R - nr. 1 - D=20
DP router bits

Z052.401.N - nr. 1
Wrenches for collet nut "standard" ER 32

Z052.315.N - nr. 1
Hook wrench 95/100 for art. T139.501.RK Tornado®

L115.050.R - nr. 4 - D=5x70
L115.050.L - nr. 4 - D=5x70
L115.080.R - nr. 2 - D=8x70
L115.080.L - nr. 2 - D=8x70
HW dowel drills extra time Z=2

L141.350.R - nr. 1 - D=35
HW hinge boring bits Z=2+2

T139.501.RK - nr. 1
Dust & chip extraction nut type ER 32 - DIN6499 Tornado®

HSK63F for ER 40 spring collets

Item

X118.002.N

Complete with:

T118.980.R - nr. 2
Collet chucks HSK63F for ER 40

T123.080.R - nr. 1 - D=8
T123.120.R - nr. 1 - D=12
T123.160.R - nr. 1 - D=16
T123.200.R - nr. 1 - D=20
Spring collet ER 40 - DIN 6499

T144.161.R - nr. 1 - D=16
Solid carbide spiral cutters, roughing style Z=3

T142.081.R - nr. 1 - D=8
T142.120.R - nr. 1 - D=12
Solid carbide spiral cutters, finish style Z=2

X502.203.R - nr. 1 - D=20
DP router bits

Z052.402.N - nr. 1
Wrenches for collet nut "standard" ER 40

Z052.315.N - nr. 1
Hook wrench 95/100 for art. T139.502.RK Tornado®

L115.050.R - nr. 4 - D=5x70
L115.050.L - nr. 4 - D=5x70
L115.080.R - nr. 2 - D=8x70
L115.080.L - nr. 2 - D=8x70
HW dowel drills extra time Z=2

L141.350.R - nr. 1 - D=35
HW hinge boring bits Z=2+2

T139.502.RK - nr. 1
Dust & chip extraction nut type ER 40 - DIN6499 Tornado®

HSK63F for EOC25 spring collets

Item

X118.003.N

Complete with:

T118.984.R - nr. 2
Collet chucks HSK63F for EOC25 with ball bearing

T124.080.R - nr. 1 - D=8
T124.120.R - nr. 1 - D=12
T124.160.R - nr. 1 - D=16
T124.200.R - nr. 1 - D=20
Spring collet EOC25 - DIN 6388

T144.161.R - nr. 1 - D=16
Solid carbide spiral cutters, roughing style Z=3

T142.081.R - nr. 1 - D=8
T142.120.R - nr. 1 - D=12
Solid carbide spiral cutters, finish style Z=2

X502.203.R - nr. 1 - D=20
DP router bits

Z052.310.N - nr. 1 (58/62)
Wrenches for collet nut EOC25/DIN6388

Z052.315.N - nr. 1
Hook wrench 95/100 for art. T139.522.RK Tornado®

L115.050.R - nr. 4 - D=5x70
L115.050.L - nr. 4 - D=5x70
L115.080.R - nr. 2 - D=8x70
L115.080.L - nr. 2 - D=8x70
HW dowel drills extra time Z=2

L141.350.R - nr. 1 - D=35
HW hinge boring bits Z=2+2

T139.522.RK - nr. 1
Dust & chip extraction nut type EOC25- DIN6388 Tornado®

TOOL KIT FOR CNC ROUTERS

ART. X118

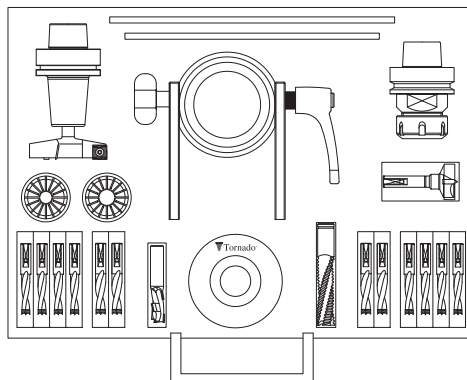

HSK63F for ER 32 spring collets

Item

X118.011.N

Complete with:

T118.976.R - nr. 1

Collet chucks HSK63F for ER 32

T119.120.R - nr. 1 - D=12

T119.160.R - nr. 1 - D=16

Spring collet ER 32 - DIN 6499

T144.161.R - nr. 1 - D=16

Solid carbide spiral cutters, roughing style Z=3

X500.120.R - nr. 1 - D=12

DP router bits

WE190.800.R - nr. 1 - D=80

Frese con coltellini HW per spianare Z=3

T120.620.R - nr. 1 - D=12

Shrink fit chucks HSK63F

Z052.401.N - nr. 1

Chiavi per ghiera tipo standard ER 32

Z052.315.N - nr. 1

Chiavi a settore 95/100 per art. T139.501.RK Tornado®

L115.050.R - nr. 4 - D=5x70

L115.050.L - nr. 4 - D=5x70

L115.080.R - nr. 2 - D=8x70

L115.080.L - nr. 2 - D=8x70

HW dowel drills extra time Z=2

L141.350.R - nr. 1 - D=35

HW hinge boring bits Z=2+2

T139.163.N - nr. 1

Adjustable demount devices

T139.501.RK - nr. 1

Dust & chip extraction nut type ER 32 - DIN6499 Tornado®

HSK63F for ER 40 spring collets

Item

X118.012.N

Complete with:

T118.980.R - nr. 1

Collet chucks HSK63F for ER 40

T123.120.R - nr. 1 - D=12

T123.160.R - nr. 1 - D=16

Spring collet ER 40 - DIN 6499

T144.161.R - nr. 1 - D=16

Solid carbide spiral cutters, roughing style Z=3

X500.120.R - nr. 1 - D=12

DP router bits

WE190.800.R - nr. 1 - D=80

Frese con coltellini HW per spianare Z=3

T120.620.R - nr. 1 - D=12

Shrink fit chucks HSK63F

Z052.402.N - nr. 1

Chiavi per ghiera tipo standard ER 40

Z052.315.N - nr. 1

Chiavi a settore 95/100 per art. T139.502.RK Tornado®

L115.050.R - nr. 4 - D=5x70

L115.050.L - nr. 4 - D=5x70

L115.080.R - nr. 2 - D=8x70

L115.080.L - nr. 2 - D=8x70

HW dowel drills extra time Z=2

L141.350.R - nr. 1 - D=35

HW hinge boring bits Z=2+2

T139.163.N - nr. 1

Adjustable demount devices

T139.502.RK - nr. 1

Dust & chip extraction nut type ER 40 - DIN6499 Tornado®

HSK63F for EOC25 spring collets

Item

X118.013.N

Complete with:

T118.984.R - nr. 1

Collet chucks HSK63F for EOC25 with ball bearing

T124.120.R - nr. 1 - D=12

T124.160.R - nr. 1 - D=16

Spring collet EOC25 - DIN 6388

T144.161.R - nr. 1 - D=16

Solid carbide spiral cutters, roughing style Z=3

X500.120.R - nr. 1 - D=12

DP router bits

WE190.800.R - nr. 1 - D=80

Frese con coltellini HW per spianare Z=3

T120.620.R - nr. 1 - D=12

Shrink fit chucks HSK63F

Z052.310.N - nr. 1 (58/62)

Chiavi a settore per ghiera EOC25/DIN6388

Z052.315.N - nr. 1

Chiavi a settore 95/100 per art. T139.522.RK Tornado®

L115.050.R - nr. 4 - D=5x70

L115.050.L - nr. 4 - D=5x70

L115.080.R - nr. 2 - D=8x70

L115.080.L - nr. 2 - D=8x70

HW dowel drills extra time Z=2

L141.350.R - nr. 1 - D=35

HW hinge boring bits Z=2+2

T139.163.N - nr. 1

Adjustable demount devices

T139.522.RK - nr. 1

Dust & chip extraction nut type EOC25 - DIN6388 Tornado®

ROUTER BITS FOR ALUMINIUM, PLASTIC, ALUCOBOND AND ADVANCED MATERIALS



SOLID CARBIDE SPIRAL BITS
DOWN CUT Z=1
Page 8.05



SOLID CARBIDE SPIRAL BITS
DOWN CUT Z=1 **KleinDIA** COATED
Page 8.05



VHW ROUTER BITS Z=2
Page 8.05



SOLID CARBIDE SPIRAL BITS
UP CUT Z=1
Page 8.05



SOLID CARBIDE SPIRAL BITS
UP CUT Z=1 **KleinDIA** COATED
Page 8.05



SOLID CARBIDE SPIRAL BITS
UP CUT Z=1 - Z=2
Page 8.06



SOLID CARBIDE SPIRAL BITS
UP CUT Z=1 - Z=2 **KleinDIA** COATED
Page 8.06



SOLID CARBIDE SPIRAL BITS CUT
Z=1 - Z=2 LONG TYPE
Page 8.07



SOLID CARBIDE SPIRAL BITS CUT
Z=1 - Z=2 LONG TYPE **KleinDIA** COATED
Page 8.07



SOLID CARBIDE SPIRAL BITS UP CUT Z=1
SHORT TYPE
Page 8.07



SOLID CARBIDE SPIRAL BITS UP CUT Z=1
SHORT TYPE **KleinDIA** COATED
Page 8.07



SOLID CARBIDE SPIRAL BITS
UP CUT Z=2
Page 8.08



SOLID CARBIDE SPIRAL BITS
DOWN CUT Z=2 **KleinDIA** COATED
Page 8.08



SOLID CARBIDE SPIRAL CUTTERS Z=5
SUPER-FINISHING **KleinDIA** COATED
Page 8.08



HS-E UPCUT SPIRAL BITS FOR
ALUMINIUM Z=1
Page 8.09



HS-E UPCUT SPIRAL BITS FOR
ALUMINIUM Z=1 **KleinDIA** COATED
Page 8.09



SET FOR ALU
Page 8.09



HS-E UPCUT SPIRAL BITS FOR
ALUMINIUM Z=1
Page 8.10



HS-E UPCUT SPIRAL BITS FOR
ALUMINIUM Z=1 LONG TYPE,
KleinDIA COATED
Page 8.10



HS-E UPCUT SPIRAL CUTTERS FOR
ALUMINIUM Z=2-Z=3
Page 8.10





SOLID CARBIDE SPIRAL BITS UP CUT Z=2
Page 8.10



SOLID CARBIDE SPIRAL BITS UP CUT Z=4
Page 8.10

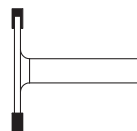

T-SLOT HW CUTTERS Z=4
Page 8.11



VHW V-GROOVE AND SIGNMAKING BITS Z=1
Page 8.11



SOLID CARBIDE TAPERED BALL NOSE SPIRAL BITS Z=3
Page 8.11



SOLID CARBIDE SPIRAL CUTTERS RADIUS STYLE Z=2
Page 8.11

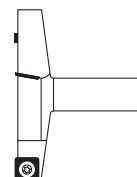

HW INSERT ROUTER BITS FOR PLASTIC MATERIAL
Page 8.12



VHW TWIST DRILLS Z=2
Page 8.12

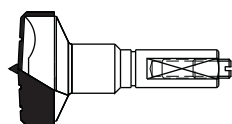

HW HINGE BORING BITS FOR ALUMINIUM Z=2
Page 8.12



SOLID CARBIDE DOUBLE DIAMETER SPIRAL BITS Z=1
Page 8.12



HS-E DOUBLE DIAMETER SPIRAL BITS FOR ALUMINIUM Z=2
Page 8.12



HS-E DOUBLE DIAMETER SPIRAL BITS FOR ALUMINIUM Z=2
Page 8.13

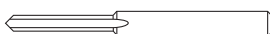

HS-E SPECIAL BITS FOR PVC Z=1
Page 8.13



HS-E SPECIAL BITS FOR PVC Z=2
Page 8.13



HS-E DRILLING BITS FOR PVC AND ALUMINIUM WORKING Z=2
Page 8.13



HS-E DRILLING BITS FOR PVC AND ALUMINIUM WORKING Z=2
Page 8.13



SOLID CARBIDE BITS FOR FIBERGLASS WORKING KleinDIA COATED
Page 8.13



SOLID CARBIDE SPIRAL CUTTERS Z=2, KleinDIA COATED
Page 8.14



VHW SPIRAL CUTTER DOWNCUT WITH DIAMOND GRIT COATING
Page 8.14



VHW FLUSH TRIMMING BITS WITH DIAMOND GRIT COATING
Page 8.14



VHW FLUSH TRIMMING BITS WITH DIAMOND GRIT COATING
Page 8.14



VHW STRAIGHT BITS FOR WORKING ALUCOBOND® AND ACM
Page 8.14



HW DRILLS FOR WORKING ALUCOBOND® Z=2
Page 8.15



SOLID CARBIDE BITS FOR WORKING ALUCOBOND® Z=2
Page 8.15

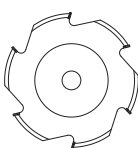

CARBIDE TIPPED MILLING CUTTERS FOR ALUCOBOND® AND ACM
Page 8.15

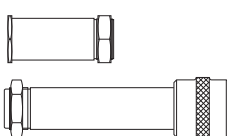

HOLDING SLEEVES FOR MILLING CUTTER SETS. TYPE: MANUAL AND QUICK CHANGE
Page 8.16

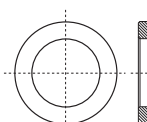

SPACERS
Page 8.16



HW ALTERNATE TOOTH MILLING CUTTERS
Page 8.16

INDUSTRIAL QUALITY TOOLS FOR ALUMINIUM AND PVC

Leading manufacturer of tools for the industrial processing of aluminium, PVC, plastic, advanced materials and Alucobond.

ALUMINIUM

Thanks to numerous collaborations with machine manufacturers, façade producers and dealers in the window and door industry, we have developed and expanded our product line for processing aluminium, lightweight alloys and non-ferrous metals. We have always been careful to offer innovative and high quality products to guarantee high performance for all types of industrial processing, always ensuring maximum reliability and precision to our customers.

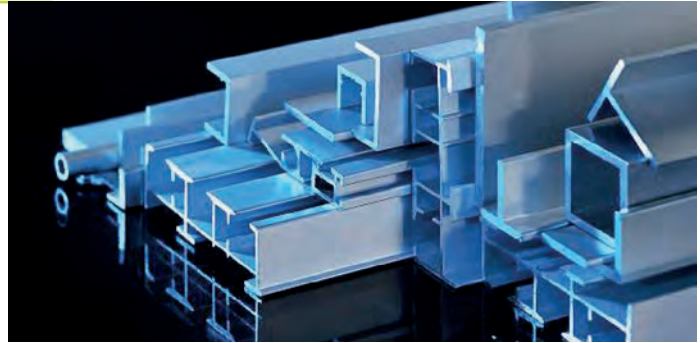

PVC AND PLASTIC

The processing of PVC profiles for modern window frames is constantly being upgraded, so we have increased our range of PVC and plastic processing products to offer state-of-the-art, high-tech products for all types of customers, from small window manufacturers to large industries.



ADVANCED MATERIALS

The machining of Advanced Materials is constantly growing and has become an important part of the industrial segment. We have therefore developed and produced tools that can meet the new market requirements to meet the most demanding quality standards in the machining of thermoplastics and composite materials, fiberglass, phenolic, hard plastics, plexiglass, ...



ALUCOBOND®

Alucobond® is a sandwich flat panel that consists of two thin aluminum sheets bonded to a non-aluminum core. ACM panels are being used to decorate interior office and as external cladding in buildings. When shaping the ACM panels, you must use a router bit specifically designed to groove the materials in the exact degree needed for the fold. Klein® router bits were designed for cutting aluminum and plastic sandwich materials like ALUCOBOND®, ALUPANEL®, REYNOBOND®, DIBOND®, STACBOND® with 90° and 135° angles. All bits are designed with flat bottoms with long-lasting industrial quality carbide.



www.aluklein.com
Our website specifically made with all the tooling for processing **Aluminium and Plastic material.**



KleinDIA®

**DLC COATING FOR
EXCELLENT PERFORMANCE
AND LONGER LIFETIME**



KleinDIA® is the most advantageous coating, ensuring:

- Production increase
- Better finishing
- Less maintenance
- Longer lifetime

TECHNICAL FEATURES:

- High hardness Hv0,025: 2500-3100
- Higher wear resistance (longer working time)
- Low frictional coefficient (lowered working temperature)
- Very low sticking coefficient (Better chips evacuation)
- Thickness: appr. 1 micron
- Colour: bright black



SOFTWOOD - HARDWOOD



MDF - CHIPBOARD



VENEERED AND LAMINATES



ADVANCED MATERIALS



ALUMINIUM



PLASTIC MATERIAL
SOLID SURFACE



PLASTIC COATED



PLEXIGLASS

UP TO
4/6X
TOOL LIFE

SOLID CARBIDE SPIRAL BITS DOWN CUT Z=1

ART. U101

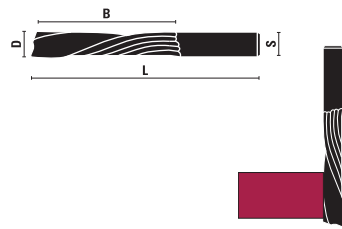

- Right-hand rotation with "DOWN CUT SPIRAL"
- Polished cutting edge for improved chip evacuation
- Use on CNC and high speed machines
- For working plastic materials (thin prefinished panels, 3/4 mm.), PVC, HDPE, PET, acrylic materials and solid surface

RH rotation	D	B	L	S
U101.030.R	3	15	50	3
U101.040.R	4	35	70	4
U101.041.R	4	20	60	4
U101.050.R	5	35	70	5
U101.051.R	5	25	60	5
U101.060.R	6	35	80	6
U101.061.R	6	25	70	6
U101.080.R	8	35	80	8
U101.081.R	8	25	70	8
U101.100.R	10	35	80	10
U101.101.R	10	25	70	10
U101.120.R	12	35	80	12

SOLID CARBIDE SPIRAL BITS DOWN CUT Z=1

Klein^{DIA} COATED

ART. U101.KD

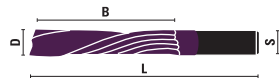

UP TO
4/6X
TOOL LIFE

- Right-hand rotation with "DOWN CUT SPIRAL"
- Polished and coated cutting edge for improved chip evacuation and less friction for excellent performance
- Use on CNC and high speed machines
- For working plastic materials (thin prefinished panels, 3/4 mm.), PVC, HDPE, PET, acrylic materials and solid surface

RH rotation	D	B	L	S
U101.030.RKD	3	15	50	3
U101.040.RKD	4	35	70	4
U101.041.RKD	4	20	60	4
U101.050.RKD	5	35	70	5
U101.051.RKD	5	25	60	5
U101.060.RKD	6	35	80	6
U101.061.RKD	6	25	70	6
U101.080.RKD	8	35	80	8
U101.081.RKD	8	25	70	8
U101.100.RKD	10	35	80	10
U101.101.RKD	10	25	70	10
U101.120.RKD	12	35	80	12

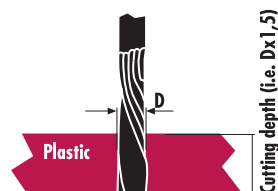
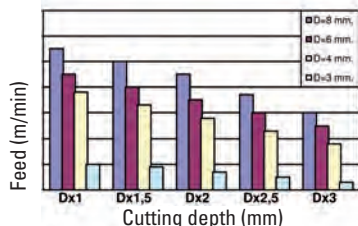

VHW ROUTER BITS Z=2

ART. T112

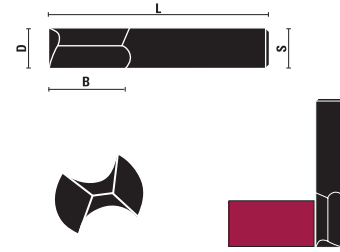

- Solid carbide
- Indicated for plastic and acrylic material, plexiglass, polypropylene etc.
- "0" flute straight

RH rotation	D	B	L	S
T112.050.R	5	12	48	5
T112.060.R	6	14	50	6
T112.080.R	8	18	55	8
T112.100.R	10	20	58	10
T112.120.R	12	26	64	12

SOLID CARBIDE SPIRAL BITS UP CUT Z=1

ART. U102

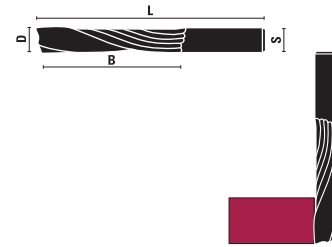

- Right-hand rotation with "UP CUT SPIRAL"
- Polished cutting edge for improved chip evacuation
- Use on CNC and high speed machines
- For working plastic materials, fiberglass, phenols materials and solid surface

RH rotation	D	B	L	S
U102.040.R	4	35	70	4
U102.050.R	5	35	70	5
U102.060.R	6	35	80	6
U102.080.R	8	35	80	8
U102.100.R	10	35	80	10

SOLID CARBIDE SPIRAL BITS UP CUT Z=1

Klein^{DIA} COATED

ART. U102.KD

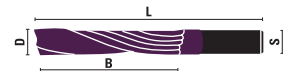

UP TO
4/6X
TOOL LIFE

- Right-hand rotation with "UP CUT SPIRAL"
- Polished and coated cutting edge for improved chip evacuation and less friction for excellent performance
- Use on CNC and high speed machines
- For working plastic materials, fiberglass, phenols materials and solid surface

RH rotation	D	B	L	S
U102.040.RKD	4	35	70	4
U102.050.RKD	5	35	70	5
U102.060.RKD	6	35	80	6
U102.080.RKD	8	35	80	8
U102.100.RKD	10	35	80	10

SOLID CARBIDE SPIRAL BITS UP CUT Z=1 - Z=2

ART. U111 - U112

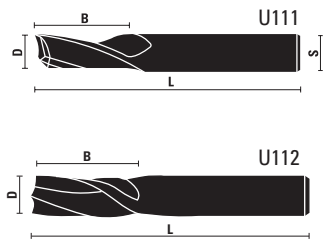

- Right-hand rotation with "UP CUT SPIRAL"
- Polished cutting edge for improved chip evacuation. Mirror finish
- Spiral 'O' flute sharpening
- Use on CNC and high speed machines
- For working: • aluminium • fiberglass • plastic • phenolic • acrylic • PVC

RH rotation	D	B	L	S	Z
U111.030.R	3	12	60	6	1
U111.032.R	1/8"	1/2"	2"	1/4"	1
U111.040.R	4	12	60	6	1
U111.048.R	3/16"	5/8"	2"	1/4"	1
U111.050.R	5	16	60	6	1
U111.060.R	6	16	60	6	1
U111.061.R	6	35	80	6	1
U111.064.R	1/4"	3/4"	2"	1/4"	1
U111.080.R	8	18	60	8	1
U111.081.R	8	35	80	8	1
U111.095.R	3/8"	3/4"	3"	3/8"	1
U111.100.R	10	22	70	10	1
U111.101.R NEW	10	25	90	10	1
U111.120.R	12	24	70	12	1
U111.127.R	1/2"	1-1/4"	3"	1/2"	1
U112.040.R	4	10	60	6	2
U112.048.R	3/16"	1/2"	2"	1/4"	2
U112.050.R	5	12	60	6	2
U112.060.R	6	15	60	6	2
U112.064.R	1/4"	3/4"	2"	1/4"	2
U112.080.R	8	20	60	8	2
U112.095.R	3/8"	1"	3"	3/8"	2
U112.100.R	10	22	70	10	2
U112.120.R	12	25	80	12	2
U112.127.R	1/2"	1-1/2"	3-1/2"	1/2"	2
U112.140.R	14	25	80	14	2
U112.160.R	16	25	80	16	2

SOLID CARBIDE SPIRAL BITS UP CUT Z=1-Z=2

KleinDIA COATED

ART. U111.KD - U112.KD

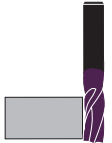
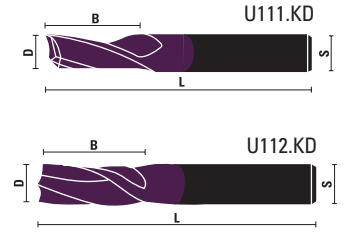

UP TO
4/6X
TOOL LIFE

- Right-hand rotation with "UP CUT SPIRAL"
- Polished and coated cutting edge for improved chip evacuation. Mirror finish
- Spiral 'O' flute sharpening
- Use on CNC and high speed machines
- For working: • aluminium • fiberglass • plastic • phenolic • acrylic • PVC

RH rotation	D	B	L	S	Z
U111.030.RKD	3	12	60	6	1
U111.032.RKD	1/8"	1/2"	2"	1/4"	1
U111.040.RKD	4	12	60	6	1
U111.048.RKD	3/16"	5/8"	2"	1/4"	1
U111.050.RKD	5	16	60	6	1
U111.060.RKD	6	16	60	6	1
U111.061.RKD	6	35	80	6	1
U111.064.RKD	1/4"	3/4"	2"	1/4"	1
U111.080.RKD	8	18	60	8	1
U111.081.RKD	8	35	80	8	1
U111.095.RKD	3/8"	3/4"	3"	3/8"	1
U111.100.RKD	10	22	70	10	1
U111.101.RKD NEW	10	25	90	10	1
U111.120.RKD	12	24	70	12	1
U111.127.RKD	1/2"	1-1/4"	3"	1/2"	1
U112.040.RKD	4	10	60	6	2
U112.048.RKD	3/16"	1/2"	2"	1/4"	2
U112.050.RKD	5	12	60	6	2
U112.060.RKD	6	15	60	6	2
U112.064.RKD	1/4"	3/4"	2"	1/4"	2
U112.080.RKD	8	20	60	8	2
U112.095.RKD	3/8"	1"	3"	3/8"	2
U112.100.RKD	10	22	70	10	2
U112.120.RKD	12	25	80	12	2
U112.127.RKD	1/2"	1-1/2"	3-1/2"	1/2"	2
U112.140.RKD	14	25	80	14	2
U112.160.RKD	16	25	80	16	2

Router bits with diameter from 12 mm to 16 mm, are produced with shank fit for Seeger retaining rings



SOLID CARBIDE SPIRAL BITS CUT Z=1 - Z=2 LONG TYPE

ART. U121 - U122

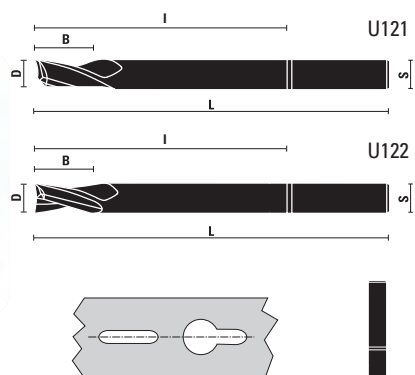

- Right-hand rotation with "UP CUT SPIRAL"

- Polished cutting edge for improved chip evacuation. Mirror finish
- Spiral 'O' flute sharpening
- Long version for **deep machining operations**
- Use on CNC and high speed machines
- Use with coolant/lubricant is recommended
- For working: aluminium, fiberglass, plastic, phenolic, acrylic, PVC

RH rotation	D	B/I	L	S	Z
U121.040.R	4	14/40	100	8	1
U121.050.R	5	18/50	100	8	1
U121.060.R	6	20/50	100	8	1
U121.080.R	8	20/70	100	8	1
U121.100.R	10	20/70	100	10	1
U121.120.R	12	35/70	100	12	1
U121.140.R NEW	14	35/70	100	14	1

U122.050.R	5	18/50	100	8	2
U122.080.R	8	20/70	100	8	2
U122.100.R	10	25/70	100	10	2

SOLID CARBIDE SPIRAL BITS CUT Z=1 - Z=2 LONG TYPE KleinDIA® COATED

ART. U121.KD - U122.KD

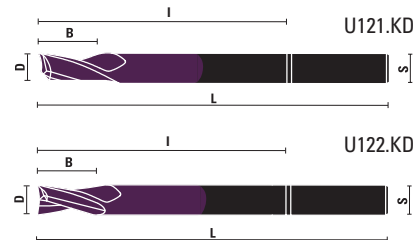

- Right-hand rotation with "UP CUT SPIRAL"

- **Longer tool life and greater cutting quality**
- Polished cutting edge for improved chip evacuation. Mirror finish
- Spiral 'O' flute sharpening
- Long version for **deep machining operations**
- Use on CNC and high speed machines
- Use with coolant/lubricant is recommended
- For working: aluminium, fiberglass, plastic, phenolic, acrylic, PVC

UP TO
4/6X
TOOL LIFE

RH rotation	D	B/I	L	S	Z
U121.040.RKD	4	14/40	100	8	1
U121.050.RKD	5	18/50	100	8	1
U121.060.RKD	6	20/50	100	8	1
U121.080.RKD	8	20/70	100	8	1
U121.100.RKD	10	20/70	100	10	1
U121.120.RKD	12	35/70	100	12	1
U121.140.RKD NEW	14	35/70	100	14	1

U122.050.RKD	5	18/50	100	8	2
U122.080.RKD	8	20/70	100	8	2
U122.100.RKD	10	25/70	100	10	2

SOLID CARBIDE SPIRAL BITS UP CUT Z=1 SHORT TYPE

ART. U125

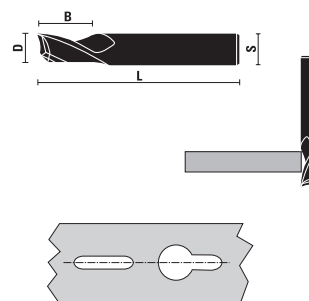

- Right-hand rotation with "UP CUT SPIRAL"

- Polished cutting edge for improved chip evacuation. Mirror finish
- Spiral 'O' flute sharpening
- Shorter cutting edge spiral version to **reduce vibration**, increase stability and have a better finish
- Use on CNC and high speed machines
- Use with coolant/lubricant is recommended
- For working: aluminium, fiberglass, plastic, phenolic, acrylic, PVC

RH rotation	D	B	L	S	Z
U125.040.R	4	8	50	6	1
U125.050.R	5	10	50	6	1
U125.060.R	6	12	50	6	1

SOLID CARBIDE SPIRAL BITS UP CUT Z=1 SHORT TYPE KleinDIA® COATED

ART. U125.KD

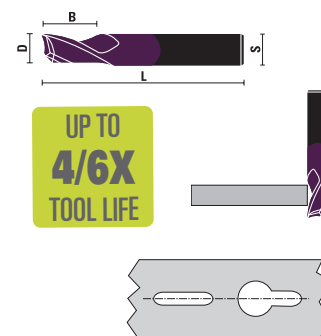

UP TO
4/6X
TOOL LIFE

- Right-hand rotation with "UP CUT SPIRAL"

- **Longer tool life and greater cutting quality**
- Polished cutting edge for improved chip evacuation. Mirror finish
- Spiral 'O' flute sharpening
- Shorter cutting edge spiral version to **reduce vibration**, increase stability and have a better finish
- Use on CNC and high speed machines
- Use with coolant/lubricant is recommended
- For working: aluminium, fiberglass, plastic, phenolic, acrylic, PVC

RH rotation	D	B	L	S	Z
U125.040.RKD	4	8	50	6	1
U125.050.RKD	5	10	50	6	1
U125.060.RKD	6	12	50	6	1

SOLID CARBIDE SPIRAL BITS UP CUT Z=2

ART. U120

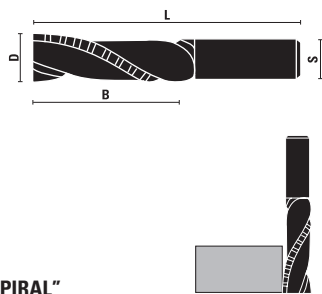

- Right-hand rotation with "UP CUT SPIRAL"
- With **chip-breaker**
- Discontinuous **cutting edge**
- For working wood and aluminium material
- Use on CNC and high speed machines

RH rotation	D	B	L	S
U120.140.R	14	42	100	14
U120.160.R	16	42	100	16
U120.180.R	18	62	120	18
U120.200.R	20	62	120	20

Router bits with diameter from 14 mm to 20 mm, are produced with shank fit for Seeger retaining rings



SOLID CARBIDE SPIRAL BITS UP CUT Z=2

Klein^{DIA} COATED

ART. U120.KD

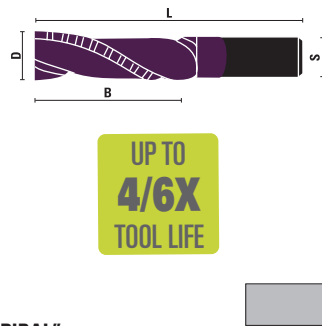

UP TO
4/6X
TOOL LIFE

- Right-hand rotation with "UP CUT SPIRAL"
- Polished and coated cutting edge for improved **chip evacuation and less friction for excellent performance**
- Discontinuous **cutting edge**
- For working wood and aluminium material
- With **chip-breaker**
- Use on CNC and high speed machines

RH rotation	D	B	L	S
U120.140.RKD	14	42	100	14
U120.160.RKD	16	42	100	16
U120.180.RKD	18	62	120	18
U120.200.RKD	20	62	120	20

SOLID CARBIDE SPIRAL CUTTERS Z=5 SUPER-FINISHING **Klein**^{DIA} COATED

ART. U115.KD

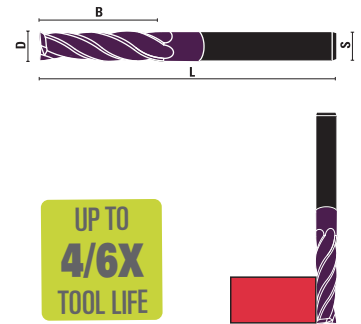

UP TO
4/6X
TOOL LIFE

- For working **plexiglass and acrylic**
- Right-hand rotation with "UP CUT SPIRAL"
- Polished and coated cutting edge for improved **chip evacuation and less friction for excellent performance**
- To be used on machining centres and CNC routers
- Especially made for plexiglass polishing and best finishing cuts

RH rotation	D	B	L	S
U115.060.RKD	6	25	70	6
U115.080.RKD	8	30	80	8
U115.100.RKD	10	35	80	10



HS-E UPCUT SPIRAL BITS FOR ALUMINIUM Z=1

ART. U201 - U211 - U221

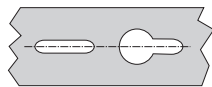
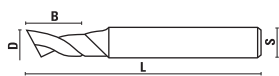

- Manufactured in HS 5% cobalt
- Used for alu profiles
- Plunging and routing
- Use with lubricant

RH rotation	D	B	L	S	Z
U201.030.R	3	12	60	8	1
U201.040.R	4	12	60	8	1
U201.041.R	4	40	100	8	1
U201.042.R	4	12	100	8	1
U201.050.R	5	14	70	8	1
U201.051.R	5	40	100	8	1
U201.052.R	5	14	100	8	1
U201.053.R	5	14	120	8	1
U201.054.R	5	25	70	8	1
U201.055.R	5	25	100	8	1
U201.056.R	5	40	120	8	1
U201.060.R	6	14	70	8	1
U201.061.R	6	40	100	8	1
U201.062.R	6	14	100	8	1
U201.063.R	6	25	70	8	1
U201.070.R	7	14	70	8	1
U201.080.R	8	14	80	8	1
U201.081.R	8	30	100	8	1
U201.082.R	8	14	100	8	1
U201.083.R	8	14	120	8	1
U201.084.R	8	25	80	8	1
U201.085.R	8	25	120	8	1
U201.090.R	9	14	80	8	1
U201.100.R	10	14	80	8	1
U201.101.R	10	14	100	8	1
U201.102.R	10	14	120	8	1
U201.120.R	12	14	80	8	1
U211.030.R	3	12	60	6	1
U211.040.R	4	12	60	6	1
U211.050.R	5	14	60	6	1
U211.060.R	6	14	60	6	1
U211.061.R	6	27	70	6	1
U221.030.R	3	12	60	10	1
U221.040.R	4	12	60	10	1
U221.050.R	5	14	60	10	1
U221.060.R	6	14	60	10	1
U221.080.R	8	14	80	10	1
U221.100.R	10	14	80	10	1
U221.101.R	10	14	120	10	1
U221.120.R	12	14	80	10	1

HS-E UPCUT SPIRAL BITS FOR ALUMINIUM Z=1, Klein^{DIA} COATED

ART. U201.KD

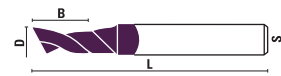

UP TO
4/6X
TOOL LIFE

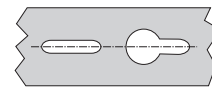

- Manufactured in HS 5% cobalt
- Polished and coated cutting edge for improved chip evacuation and less friction for excellent performance
- Used for alu profiles
- Plunging and routing
- Use with lubricant

RH rotation	D	B	L	S	Z
U201.040.RKD	4	12	60	8	1
U201.050.RKD	5	14	70	8	1
U201.060.RKD	6	14	70	8	1
U201.080.RKD	8	14	70	8	1
U201.081.RKD	8	30	100	8	1
U201.100.RKD	10	14	80	8	1

SET FOR ALU

ART. X015



Wooden box

Item
X015.009.R
9-pcs set for alu:
U201.030.R
U201.040.R
U201.050.R
U201.060.R
U201.080.R
U201.100.R
U202.050.R
U202.060.R
U202.080.R

HS-E UPCUT SPIRAL BITS FOR ALUMINIUM Z=1

ART. U202

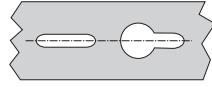
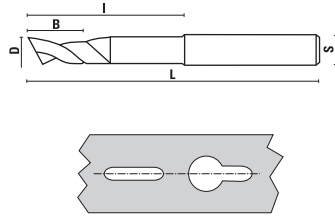

- Manufactured in HS 5% cobalt
- Used for alu profiles
- Plunging and routing
- Use with lubricant
- Reduced throat execution for a better chip ejection

RH rotation	D	B/l	L	S	Z
U202.040.R	4	16/55	90	8	1
U202.050.R	5	14/35	80	8	1
U202.051.R	5	14/35	120	8	1
U202.052.R	5	16/55	90	8	1
U202.053.R	5	18/35	100	8	1
U202.054.R	5	20/45	100	8	1
U202.055.R	5	20/55	80	10	1
U202.056.R	5	20/55	100	10	1
U202.060.R	6	14/55	85	8	1
U202.061.R	6	14/35	80	8	1
U202.062.R	6	14/45	90	8	1
U202.063.R	6	20/55	100	10	1
U202.080.R	8	14/60	80	8	1
U202.081.R	8	14/90	120	8	1
U202.082.R	8	14/70	100	8	1
U202.083.R	8	30/70	100	8	1
U202.100.R	10	14/60	80	10	1
U202.101.R	10	14/70	100	10	1
U202.102.R	10	14/95	120	10	1
U202.103.R	10	30/70	100	10	1

HS-E UPCUT SPIRAL BITS FOR ALUMINIUM Z=1 LONG TYPE, KleinDIA COATED

ART. U202.KD

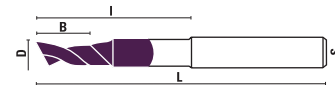

UP TO
4/6X
TOOL LIFE

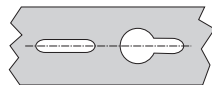

- Manufactured in HS 5% cobalt
- Polished and coated cutting edge for improved chip evacuation and less friction for excellent performance
- Used for alu profiles
- Plunging and routing
- Reduced throat execution for a better chip ejection
- Use with lubricant

RH rotation	D	B/l	L	S	Z
U202.050.RKD	5	14/35	80	8	1
U202.080.RKD	8	14/60	80	8	1
U202.083.RKD	8	30/70	100	8	1
U202.102.RKD	10	14/95	120	8	1

HS-E UPCUT SPIRAL CUTTERS FOR ALUMINIUM Z=2-Z=3

ART. U250

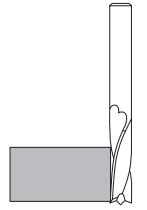
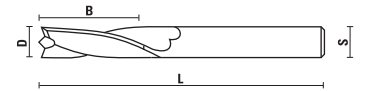

- Manufactured in HS 5% cobalt
- Use on CNC and milling machines
- For working aluminum and ferrous materials

RH rotation	D	B	L	S	Z
U250.040.R	4	12	63	6	2
U250.050.R	5	25	68	6	2
U250.060.R	6	25	68	6	2
U250.080.R	8	25	88	8	2
U250.100.R	10	35	95	10	2
U250.120.R	12	35	110	12	2
U250.140.R	14	37	110	14	3
U250.160.R	16	40	123	16	3
U250.180.R	18	40	123	18	3
U250.200.R	20	45	130	20	3

SOLID CARBIDE SPIRAL BITS UP CUT Z=2

ART. U150

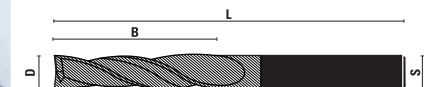

- "RT" with special coating **TICN** for working inox and ferrous materials
- Use on CNC machines
- For working aluminum and ferrous materials

RH rotation	D	B	L	S
U150.060.R	6	16	60	6
U150.080.R	8	45	100	8
U150.100.R	10	22	70	10
U150.060.RT	6	16	60	6
U150.080.RT	8	45	100	8
U150.100.RT	10	22	70	10

SOLID CARBIDE SPIRAL BITS UP CUT Z=4

ART. U155 - U156

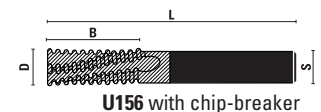
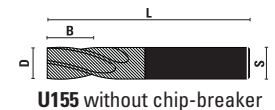

- "RT" with special coating "TINALOX"
- Use on CNC machines
- For working inox and ferrous materials

RH rotation	D	B	L	S	Z
U155.060.RT	6	15	60	6	4
U155.080.RT	8	19	65	8	4
U156.060.RT	6	21	60	6	4 chip-breaker
U156.080.RT	8	25	70	8	4 chip-breaker

T-SLOT HW CUTTERS Z=4

ART. C173

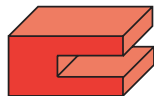
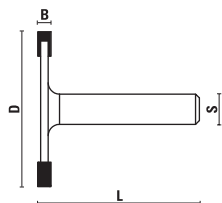

Four wings t-slot cutters for working wood, plastic material and aluminum



S Ø 8	D	B	L
C173.020.R	41	2	43
C173.025.R	41	2,5	43
C173.030.R	41	3	44
C173.035.R	41	3,5	44
C173.040.R	41	4	45
C173.045.R	41	4,5	45
C173.050.R	41	5	46

SOLID CARBIDE TAPERED BALL NOSE SPIRAL BITS Z=3

ART. T173

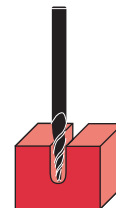

- Right-hand rotation with "UP CUT SPIRAL"
 - Specially designed for smooth 2D and 3D carving in plastic, aluminium and wood
 - Use on CNC and high speed machines

RH rotation	D	B	L	R	S
T173.008.R	1/32"	1"	3"	1/64"	1/4"
T173.009.R	0,8	25	70	0,4	6
T173.016.R	1/16"	1"	3"	1/32"	1/4"
T173.017.R	1,6	25	70	0,8	6
T173.018.R	1,6	30	80	0,8	8
T173.031.R	1/8"	1"	3"	1/16"	1/4"
T173.032.R	1/8"	2-1/2"	4"	1/16"	1/2"
T173.033.R	3,17	30	70	1,59	6
T173.034.R	3,17	50	90	1,59	8
T173.064.R	1/4"	2"	4"	1/8"	1/2"

SOLID CARBIDE SPIRAL CUTTERS RADIUS STYLE Z=2

ART. T175

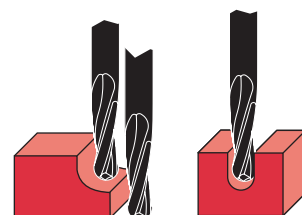

- Suitable for working plastic materials
 - Right-hand rotation with "UP CUT SPIRAL"

RH rotation	D	R	B	L	S	Z
T175.030.R	3	1,5	12	50	3	2
T175.040.R	4	2	12	50	4	2
T175.060.R	6	3	22	60	6	2
T175.080.R	8	4	22	80	8	2
T175.100.R	10	5	35	80	10	2
T175.120.R	12	6	35	80	12	2
T175.160.R	16	8	55	100	16	2
T175.180.R	18	9	55	110	18	2
T175.200.R	20	10	55	110	20	2



- Perfect bit for 2D and 3D carving, deep profiling, dimensional signage, model-makers, modeling and pattern for cabinetry, sign making, furniture making

- Also known as straight ballnose router bits with straight angle and radius on top.

VHW V-GROOVE AND SIGNMAKING BITS Z=1

ART. A109 - B109

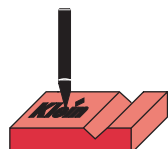

- Suitable for engraving, signmaking and decorative features on wood, plastic, brass, aluminium, copper and different composite material



S Ø 6	S Ø 1/4" (6,35)	D	α	B	L	Z
A109.510.R	B109.510.R	0,1	30°	14	50	1
A109.525.R	B109.525.R	0,25	30°	14	50	1
A109.550.R	B109.550.R	0,5	30°	14	50	1
A109.600.R	B109.600.R	1	30°	14	50	1



HW INSERT ROUTER BITS FOR PLASTIC MATERIAL

ART. W190.RU – WE190.RU – WG190.RU

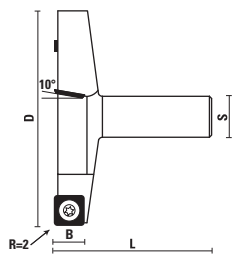

10° shear angle

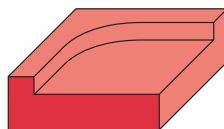

- Used for **surfacing plastic board material** and making deep rabbet (also known as Flycutters - Spoilboard cutters)
- Special insert knives with radius (R=2) for smoother cuts and no risk of marks and scratch.
- **10° shear angle** for better performance
- To be used on machining centres and CNC routers
- Right-hand rotation
- This item is sold complete with a hex key

Item	D	B	L	Z	S
W190.100.RU	100	14	80	3	∅20x55
W190.101.RU	101,6(4")	14	76(3")	3	∅19,05(3/4")x55



Z051.205.R



Z055.107.N



Z052.205.N

WE190.800.RU	80	14	76	3	∅12x50
WG190.635.RU	63,5(2-1/2")	14	70(2-3/4")	2	∅12,7(1/2")x45



Z051.020.R



Z055.107.N



Z052.103.N

VHW TWIST DRILLS Z=2

ART. L120



- Solid carbide
- 2-flutes
- For natural wood, pressed wood, veneered, chipboard, laminated and MDF
- Ideal for **Trespa, Aluminium and Plastic**
- To use with adaptor bushes Art. Z010/Z011

RH rotation	LH rotation	D	B	L
L120.020.R	L120.020.L	2	18	49
L120.025.R	L120.025.L	2,5	22	55
L120.030.R	L120.030.L	3	22	55
L120.032.R	L120.032.L	3,2	22	55
L120.035.R	L120.035.L	3,5	25	55
L120.040.R	L120.040.L	4	25	55
L120.045.R	L120.045.L	4,5	28	58
L120.050.R	L120.050.L	5	28	58
L120.060.R	L120.060.L	6	28	58

HW HINGE BORING BITS FOR ALUMINIUM Z=2

ART. U140

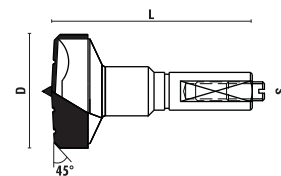

- **Chip-breaker** execution Z=2
- For working aluminium

RH rotation	D	L	S	Rot.
U140.250.R	25	57,5	10x26	RH
U140.350.R	35	57,5	10x26	RH



Z051.302.R



Z059.001.L



Z059.001.R

SOLID CARBIDE DOUBLE DIAMETER SPIRAL BITS Z=1

ART. U190



- Right-hand rotation with "UP CUT SPIRAL"
- Use on CNC machines
- For working **aluminum and non-ferrous materials**

RH rotation	d	D	B	I	L	S
U190.030.R	3	8	5	30	80	8
U190.055.R	5,5	8	10	25	100	8
U190.060.R	6	11,5	10	40	100	12

HS-E DOUBLE DIAMETER SPIRAL BITS FOR ALUMINIUM Z=2

ART. U290 - U291

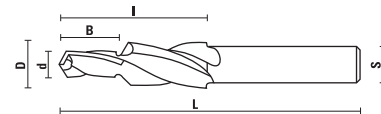

RH rotation	d/D	B/I	L	S
U290.055.R	5,5/11,5	12/35	100	10
U290.060.R	6/11,5	12/35	100	10
U290.061.R	6/12	15/35	80	10
U290.062.R	6/14	15/35	80	10
U290.065.R	6,5/13,5	15/35	100	10
U290.070.R	7/13	12/35	100	10
U290.071.R	7/14	12/35	100	10
U290.072.R	7/15	12/35	100	10
U290.080.R	8/15	12/35	100	10
U291.055.R	5,5/11,5	12/35	120	12
U291.060.R	6/12	12/35	100	12
U291.065.R	6,5/11,5	12/35	100	12
U291.066.R	6,5/12	18/45	120	12
U291.067.R	6,5/13,5	12/35	120	12
U291.085.R	8,5/14	12/35	100	12

HS-E DOUBLE DIAMETER SPIRAL BITS FOR ALUMINIUM Z=2

ART. U230

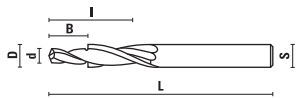

RH rotation	d/D	B/l	L	S
U230.030.R	3/6	8/15	60	6

HS-E DRILLING BITS FOR PVC AND ALUMINIUM WORKING Z=2

ART. U260

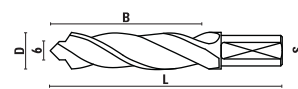

- To be used on our **Trimatic 43/0** boring jigs for mounting cremona bolt on **PVC** and/or **aluminium** doors and windows (Section 16 at page 16.09)

RH rotation	LH rotation	D	B	L	S
	U260.080.L	8	50	76	10x20
	U260.100.L	10	50	76	10x20
U260.120.R	U260.120.L	12	50	76	10x20
U260.140.R		14	50	76	10x20

HS-E SPECIAL BITS FOR PVC Z=1

ART. U240

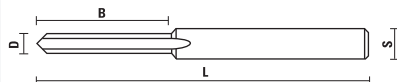

- Plunging
- For working PVC profiles on **Elumatec**, **Rotox**, **Striffler** machines

RH rotation	D	B	L	S
U240.050.R	5	35	102	8
U240.051.R	5	45	102	8
U240.052.R	5	55	102	8
U240.060.R	6	30	102	8

HS-E DRILLING BITS FOR PVC AND ALUMINIUM WORKING Z=2

ART. U270

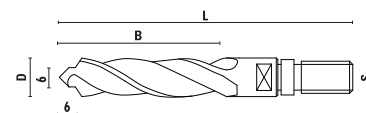

To produce holes for inserting handles on **PVC** and **aluminium** workpieces

RH rotation	LH rotation	D	B	L	S
	U270.080.L	8	50	93	M10
	U270.100.L	10	50	93	M10
	U270.120.L	12	49	93	M10
U270.120.R		12	55	98	M10
U270.140.R		14	55	98	M10

SOLID CARBIDE BITS FOR FIBERGLASS WORKING Klein^{DIA} COATED

ART. U130.KD

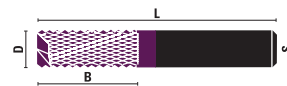

UP TO
4/6X
TOOL LIFE



- For working plastic materials, rubber and fiberglass
- Right-hand rotation
- For routing and shearing
- To be used on portable machines, CNC and routing machines

RH rotation	D	B	L	S
U130.030.RKD	3	12	38	3
U130.040.RKD	4	15	40	4
U130.050.RKD	5	18	50	5
U130.060.RKD	6	22	55	6
U130.064.RKD	1/4"	1"	3"	1/4"
U130.080.RKD	8	30	70	8
U130.095.RKD	3/8"	1-1/4"	3-1/4"	3/8"
U130.100.RKD	10	30	72	10
U130.120.RKD	12	30	73	12
U130.127.RKD	1/2"	1-1/2"	3-1/2"	1/2"

HS-E SPECIAL BITS FOR PVC Z=2

ART. U241

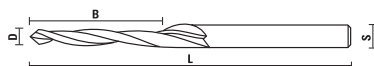

- Through hole execution
- For working PVC profiles on **Elumatec**, **Rotox**, **Striffler** machines

RH rotation	D	B	L	S
U241.050.R	5	40	100	8

**SOLID CARBIDE SPIRAL CUTTERS Z=2,
Klein^{DIA} COATED**

ART. U302.KD

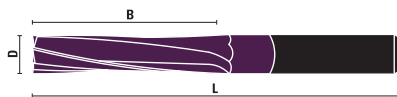

UP TO
4/6X
TOOL LIFE

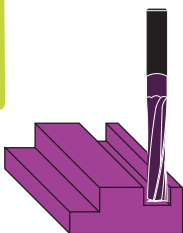

- For working Solid Surface (Corian® - Avonite®)
- Right-hand rotation with "UP CUT SPIRAL"
- Polished cutting edge for improved chip evacuation and less friction by allowing better quality cuts and longer tool life
- Special shear angle for working solid surface without breakage
- Specific solid carbide for best cutting quality

RH rotation	D	B	L	S
U302.080.RKD	8	32	80	8
U302.100.RKD	10	42	100	10
U302.120.RKD	12	42	100	12
U302.160.RKD	16	62	120	16

VHW SPIRAL CUTTER DOWNCUT WITH DIAMOND GRIT COATING

ART. XA183 - XB183

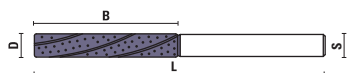

- Electro plated Diamonds
- Suitable for laminated, fiberglass, carbon fiber and composites material
- Right-hand rotation with "DOWN CUT SPIRAL"
- With special diamond coating for longer tool life
- For working with portable router and CNC

S Ø 6	S Ø 6,4 (1/4")	D	B	L
XA183.063.R	XB183.063.R	6,35 (1/4")	38	76
XA183.095.R	XB183.095.R	9,5 (3/8")	38	76

VHW FLUSH TRIMMING BITS WITH DIAMOND GRIT COATING

ART. XA119 - XB119

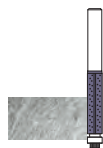
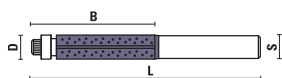

- Electro plated Diamonds
- Suitable for laminated, fiberglass, carbon fiber and composites material
- With special diamond coating for longer tool life
- For working with portable router and CNC

S Ø 6	S Ø 6,4 (1/4")	D	B	L
XA119.064.R	XB119.064.R	6,35 (1/4")	19	59
XA120.064.R	XB120.064.R	6,35 (1/4")	25	64
XA120.095.R	XB120.095.R	9,5 (3/8")	25	67

VHW FLUSH TRIMMING BITS WITH DIAMOND GRIT COATING

ART. XE146 - XG146

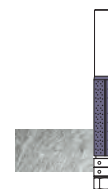
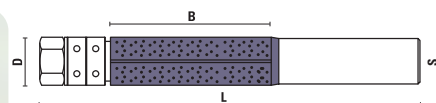

- Electro plated Diamonds
- Suitable for laminated, fiberglass, carbon fiber and composites material
- With special diamond coating for longer tool life
- For working with portable router and CNC

S Ø 6	S Ø 1/2" (12,7)	D	B	L
XE146.127.R	XG146.127.R	12,7 (1/2")	25	83
XE146.128.R	XG146.128.R	12,7 (1/2")	45	109
XE146.129.R	XG146.129.R	12,7 (1/2")	81	111

VHW STRAIGHT BITS FOR WORKING ALUCOBOND® AND ACM

ART. U108

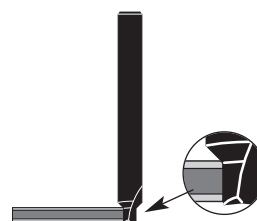

- Ideal for obtaining a smudge-free finish
- For routing on ALUCOBOND®, ALUPANEL® REYNOBOND®, DIBOND® and STACBOND®

S Ø 8	D	B	L	Z	Rot.
U108.050.R	5	4	70	2+1	Rh

HW DRILLS FOR WORKING ALUCOBOND® Z=2

ART. U180

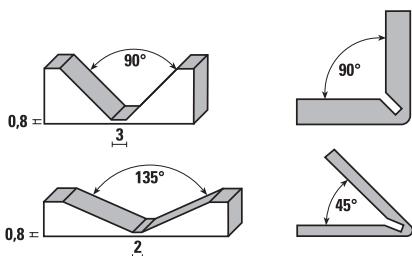
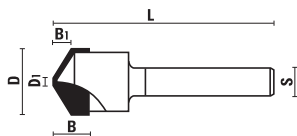

- Carbide tipped cutting edges
- For making V-groove folding on **ALUCOBOND®**, **ALUPANEL®**, **DIBOND®**
- Especially designed for scoring ACM materials with 90° and 135° angles (with flat bottoms), thus allowing a simple hand bending operation of the panel without cracking.
- For portable routers and CNC machining centres

S ∅ 8	D	D1	α	B	B1	L
U180.090.R	18	3	90°	10	8	60
U180.135.R	18	2	135°	10	3,3	60

SOLID CARBIDE BITS FOR WORKING ALUCOBOND® Z=2

ART. U181

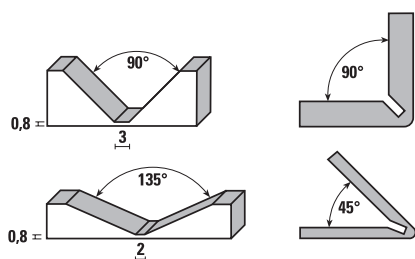
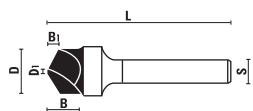

- Solid carbide cutting edges
- For making V-groove folding on **ALUCOBOND®**, **ALUPANEL®**, **DIBOND®**
- Especially designed for scoring ACM materials with 90° and 135° angles (with flat bottoms), thus allowing a simple hand bending operation of the panel without cracking.
- For portable routers and CNC machining centres

S ∅ 8	D	D1	α	B	B1	L
U181.090.R	18	3	90°	10	8	60
U181.135.R	18	2	135°	10	3,3	60

CARBIDE TIPPED MILLING CUTTERS FOR ALUCOBOND® AND ACM

ART. YU120 - YU121

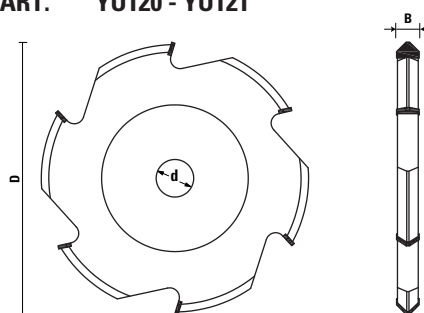

- Carbide tipped cutting edges
- For routing and folding on **ALUCOBOND®**, **ALUPANEL®**, **REYNOBOND®**, **DIBOND®**, **STACBOND®**
- Especially designed for scoring ACM (aluminium compound material) with 90° and 135° angles (with flat bottoms) and rectangular groove for foldings up to 180°, thus allowing a simple hand bending operation of the panel without cracking
- For vertical panel saw and milling machine

Item	D	B	d	Z	α	R	D1
YU120.090.R	220	18	30	8	90°	-	3
YU120.135.R	220	18	30	8	135°	-	2
YU121.040.R	219	14	30	8	-	40	-

ADVANTAGES OF FOLDING AND ROUTING TECHNIQUE:

- Minimum investment
- Simple operating technique
- Low-cost manufacture of shaped parts like façade elements, frames, fascia claddings and roof edgings, corner pieces
- Good economy
- Tension-free folding, therefore no buckling in the corner area

YU120.090.R

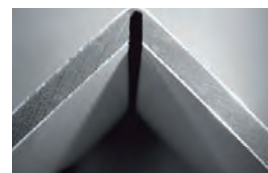
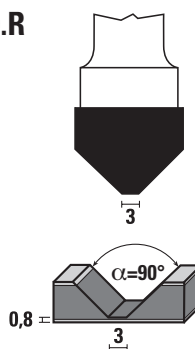

YU120.135.R

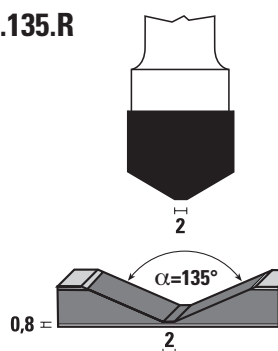

YU121.040.R

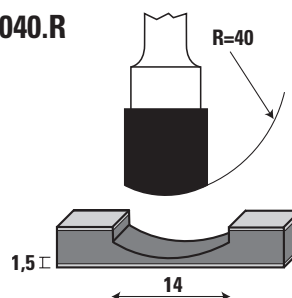

HOLDING SLEEVES FOR MILLING CUTTER SETS WITH MANUAL INSERTION

ART. YC 320

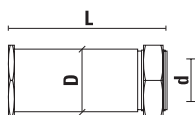

Item	D	d	L	Type
YC320.160	32	16	100	Manual
YC320.220	32	22	100	Manual
YC320.270	32	27	100	Manual

QUICK CHANGE HOLDING SLEEVES FOR MILLING CUTTER SETS

ART. YC 320

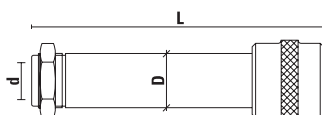

Item	D	d	L	Type
YC320.900	32	27	135	Quick Change

SPACERS

ART. YD 320

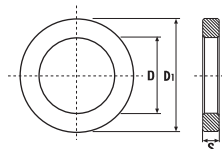

- Use with holding sleeves for aluminium working
- Burnished

Item	D	D1	S
YD320.003	32	45	0,3
YD320.005	32	45	0,5
YD320.010	32	45	1
YD320.020	32	45	2
YD320.050	32	42	5
YD320.100	32	42	10
YD320.150	32	42	15
YD320.200	32	42	20
YD320.300	32	42	30
YD320.400	32	42	40
YD320.500	32	42	50
YD320.600	32	42	60
YD320.800	32	42	80
YD320.900	32	42	90

HW ALTERNATE TOOTH MILLING CUTTERS

ART. YF 060= YF120

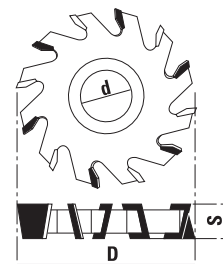

Alternate teeth for better quality of cut for aluminium

Item	D	S	d	Z	Item	D	S	d	Z
YF060.040	60	4	32	6	YF100.040	100	4	32	10
YF060.050	60	5	32	6	YF100.050	100	5	32	10
YF060.060	60	6	32	6	YF100.060	100	6	32	10
YF060.070	60	7	32	6	YF100.070	100	7	32	10
YF060.080	60	8	32	6	YF100.080	100	8	32	10
YF060.100	60	10	32	6	YF100.100	100	10	32	10
YF060.120	60	12	32	6	YF100.120	100	12	32	10
YF060.140	60	14	32	6	YF100.140	100	14	32	10
YF060.160	60	16	32	6	YF100.160	100	16	32	10
YF070.040	70	4	32	8	YF100.180	100	18	32	10
YF070.050	70	5	32	8	YF100.200	100	20	32	10
YF070.060	70	6	32	8	YF100.250	100	25	32	10
YF070.070	70	7	32	8	YF100.300	100	30	32	10
YF070.080	70	8	32	8	YF114.040	114	4	32	12
YF070.100	70	10	32	8	YF114.050	114	5	32	12
YF070.120	70	12	32	8	YF114.060	114	6	32	12
YF070.140	70	14	32	8	YF114.070	114	7	32	12
YF070.160	70	16	32	8	YF114.080	114	8	32	12
YF080.040	80	4	32	8	YF114.100	114	10	32	12
YF080.050	80	5	32	8	YF114.120	114	12	32	12
YF080.060	80	6	32	8	YF114.140	114	14	32	12
YF080.070	80	7	32	8	YF114.160	114	16	32	12
YF080.080	80	8	32	8	YF114.180	114	18	32	12
YF080.100	80	10	32	8	YF114.200	114	20	32	12
YF080.120	80	12	32	8	YF114.250	114	25	32	12
YF080.140	80	14	32	8	YF114.300	114	30	32	12
YF080.160	80	16	32	8	YF120.040	120	4	32	14
YF080.180	80	18	32	8	YF120.050	120	5	32	14
YF080.200	80	20	32	8	YF120.060	120	6	32	14
YF090.040	90	4	32	8	YF120.070	120	7	32	14
YF090.050	90	5	32	8	YF120.080	120	8	32	14
YF090.060	90	6	32	8	YF120.100	120	10	32	14
YF090.070	90	7	32	8	YF120.120	120	12	32	14
YF090.080	90	8	32	8	YF120.140	120	14	32	14
YF090.100	90	10	32	8	YF120.160	120	16	32	14
YF090.120	90	12	32	8	YF120.180	120	18	32	14
YF090.140	90	14	32	8	YF120.200	120	20	32	14
YF090.160	90	16	32	8	YF120.250	120	25	32	14
YF090.180	90	18	32	8	YF120.300	120	30	32	14
YF090.200	90	20	32	8					

SPECIAL UNITS FOR ALUMINIUM-PROFILES

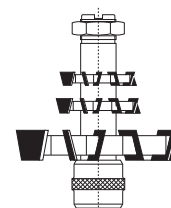

- PRODUCED ON REQUEST
- PLEASE SEND US YOUR INQUIRY WITH TECHNICAL INFORMATION RELATED

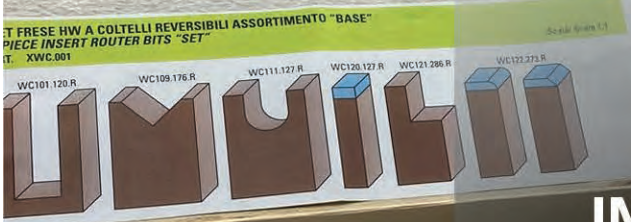

INSERT KNIVES ROUTER BITS AND DP DIAMOND ROUTER BITS

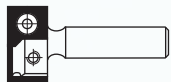

HW INSERT FLUSH TRIM BITS Z=2
Page 9.05

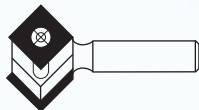

HW INSERT ANGLE BITS Z=2
Page 9.05

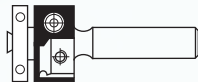

HW INSERT FLUSH TRIM BITS
WITH BALL BEARING GUIDE Z=2
Page 9.05

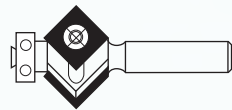

HW INSERT FLUSH TRIM BITS
WITH BALL BEARING GUIDE Z=2
Page 9.05

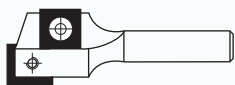

HW INSERT FLUSH BITS Z=2+1
Page 9.05



HW INSERT FLUSH BITS Z=2+1
Page 9.05



HW INSERT FLUSH TRIMMING BITS Z=2
Page 9.06



HW INSERT FLUSH TRIMMING BITS WITH
LOWER DOUBLE BALL BEARINGS Z=2
Page 9.06



HW INSERT FLUSH TRIMMING BITS Z=2
Page 9.06



HW INSERT FLUSH TRIMMING BITS WITH
UPPER DOUBLE BALL BEARINGS Z=2
Pag. 9.06



HW INSERT FLUSH TRIMMING BITS WITH
UPPER AND LOWER BALL BEARINGS Z=2
Page 9.06



HW INSERT PLUNGE
ROUTER BITS Z=1 "VERSOFIX"
Page 9.07

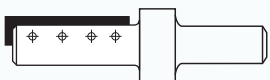

HW INSERT PLUNGE ROUTER BITS Z=1
"VERSOFIX"
Page 9.07

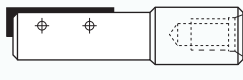

HW INSERT PLUNGE ROUTER BITS Z=1
"VERSOFIX"
Page 9.08

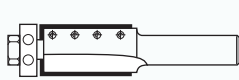

HW INSERT FLUSH TRIM
BITS Z=2 "VERSOFIX"
Page 9.08

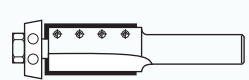

HW INSERT FLUSH TRIM
BITS Z=2 "VERSOFIX"
Page 9.08

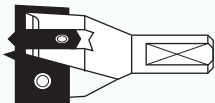

HW INSERT BORING BITS Z=2+2
Page 9.08



HW INSERT PLUNGE
ROUTER CUTTERS Z=1
Page 9.08

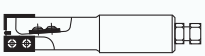

HW INSERT COMPRESSION
ROUTER CUTTERS
Page 9.09

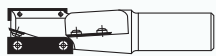

HW INSERT COMPRESSION
ROUTER CUTTER
Page 9.09

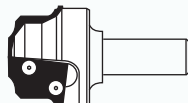

HW INSERT ROUTER BITS FOR
CABINET DOORS Z=2
Page 9.09

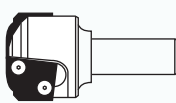

HW INSERT ROUTER BITS FOR
CABINET DOORS Z=2
Page 9.10



HW INSERT ROUTER BITS FOR
DECORATION AND ENGRAVING Z=1
Page 9.10



COMPLETE SET FOR DECORATING
AND ENGRAVING
Page 9.11



COMPLETE CUTTERS SET FOR CABINET DOORS
Page 9.11

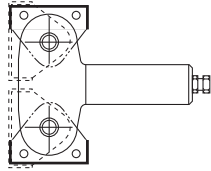

HW INSERT VARI-ANGLE ROUTER CUTTERS Z=2
Page 9.12

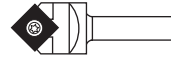

HW INSERT ROUTER BITS FOR ENGRAVINGS Z=1
Page 9.13

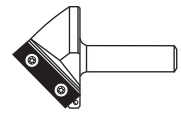

HW INSERT ROUTER BITS FOR ENGRAVINGS Z=1
Page 9.13

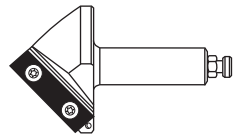

HW INSERT V-GROOVE ROUTER BITS Z=1
Page 9.13



HW INSERT V-GROOVE ROUTER BITS Z=1 FOR PLASTIC KleinDIA COATED
Pag. 9.13



HW INSERT ROUTER BITS FOR LOCKS Z=2
Page 9.14



HW INSERT ROUTER BITS FOR LOCKS Z=2 HEAVY METAL TOOL BODY
Page 9.14

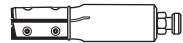

HW INSERT ROUTER BITS Z=3
Page 9.14

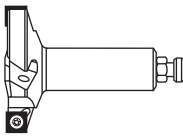

HW INSERT ROUTER BITS FOR PLANING AND RABBETING Z=2+2
Page 9.14

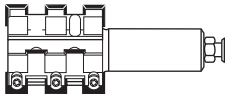

HW INSERT ROUTER CUTTERS, ROUGHING Z=4
Page 9.14

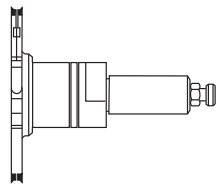

HW INSERT ADJUSTABLE ROUTER CUTTERS FOR GROOVING
Page 9.15

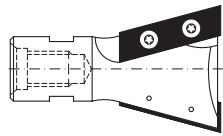

HW INSERT ROUTER BIT FOR HUNDEGGER
Page 9.15

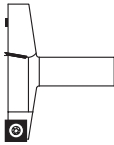

HW INSERT ROUTER BITS FOR PLANING AND RABBETING
Page 9.15

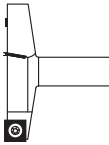

HW INSERT ROUTER BITS FOR PLASTIC MATERIAL
Page 9.16

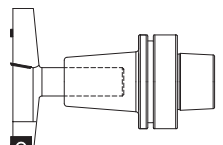

HW INSERT SPOILBOARD CUTTER INTEGRATED WITH HSK-63F
Page 9.16



HW INSERT FLUSH TRIMMING BITS Z=1
Page 9.17

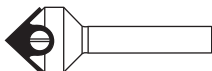

HW INSERT V-GROOVING BITS Z=1
Page 9.17

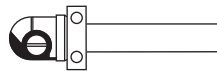

HW INSERT CORE BOX BITS WITH UPPER BALL BEARING Z=1
Page 9.17



HW INSERT FLUSH TRIMMING BITS WITH BALL BEARING
Page 9.17

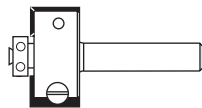

HW INSERT FLUSH TRIMMING BITS WITH BALL BEARING Z=2
Page 9.17

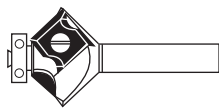

HW INSERT FLUSH TRIMMING BITS WITH BALL BEARING Z=2
Page 9.18

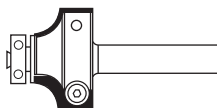

HW INSERT CORNER ROUNDING BITS WITH BALL BEARING Z=2
Page 9.18

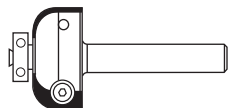

HW INSERT COVER BITS WITH BALL BEARING Z=2
Page 9.18

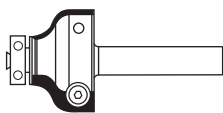

HW INSERT OGEE BITS WITH BALL BEARING Z=2
Page 9.18



6 PIECE INSERT ROUTER BITS "SET"
Page 9.18



6 PIECE INSERT ROUTER BITS "SET"
Page 9.18

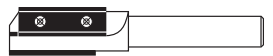

HW INSERT ROUTER BITS Z=2+1
Page 9.19

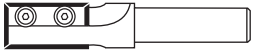

HW INSERT ROUTER BITS Z=2
WITH STRAIGHT CUTTERS
Page 9.19

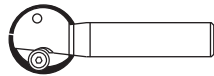

HW INSERT BALL SLOT ROUTER BITS Z=2
Page 9.19

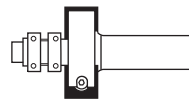

HW INSERT REBATE BITS Z=2
Page 9.19

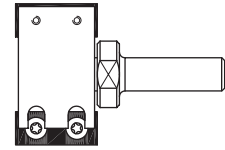

HW INSERT RABBETING BITS Z=2
Page 9.20

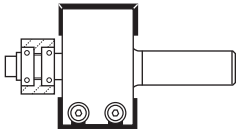

HW INSERT REBATE BITS Z=2
Page 9.20

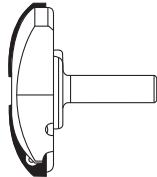

HW INSERT PROFILE RAISED PANEL
ROUTER CUTTERS Z=2
Page 9.20

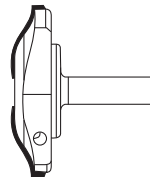

HW INSERT PROFILE RAISED PANEL
ROUTER CUTTERS Z=2
Page 9.20

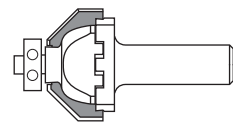

HW INTERCHANGEABLE INSERT
ROUTER BITS "NOVA SYSTEM" Z=2
Page 9.21 ÷ 9.23



DP ROUTER BITS
Page 9.23



DP ROUTER BITS
Page 9.24



DP ROUTER BITS
Page 9.24



DP ROUTER BITS Z=1
Page 9.24



DP ROUTER BITS Z=2
Page 9.24

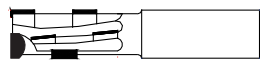

DP ROUTER BITS H=1,5
Page 9.25

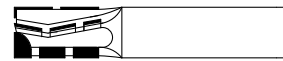

DP ROUTER BITS FOR NESTING OPERATION
Page 9.25



DP DOWEL DRILLS
Page 9.25



DP THROUGH-HOLE DRILL BITS
Page 9.25

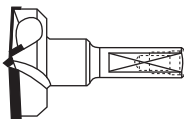

DP HINGE BORING BITS
Page 9.26

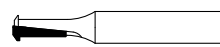

DP ROUTER BITS FOR "LAMELLO"
Page 9.26



DP TRIMMING BITS WITH
BALL BEARING Z=2
Page 9.26



DP ROUND OVER BITS WITH BALL
BEARING Z=2
Page 9.26



DP GROOVE CUTTER FOR "LAMELLO"
JOINTS CLAMEX P
Page 9.27



DP GROOVE CUTTER FOR "LAMELLO"
JOINTS
Page 9.27



DP SAW BLADES FOR CUTTING
ABRASIVE MATERIALS
Page 9.27



DP SAWBLADES FOR LAMINATES
Page 9.28



DP CONICAL SCORING SAWBLADES
Page 9.28



DP PANEL SIZING SAWBLADES
Page 9.29

HW INSERT FLUSH TRIM BITS Z=2

ART. W101 - W102

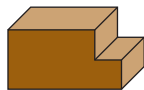
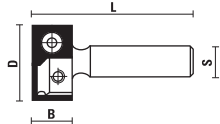

This item is sold complete with a torx key

S Ø 6	S Ø 8	D	B	L
W101.190.R		19	12	45
	W102.190.R	19	12	55



HW INSERT ANGLE BITS Z=2

ART. W103 - W104

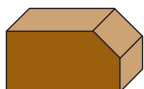
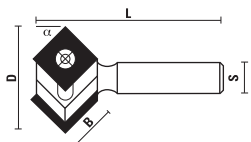

This item is sold complete with a torx key

S Ø 6	S Ø 8	D	α	B	L
W103.240.R	W104.240.R	24	22°	12	55
W103.260.R	W104.260.R	26	30°	12	55
W103.290.R	W104.290.R	29	45°	12	55



HW INSERT FLUSH TRIM BITS WITH BALL BEARING GUIDE Z=2

ART. W105 - W106

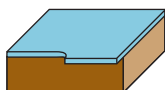
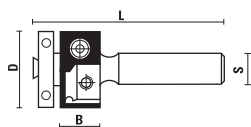

This item is sold complete with a torx key

S Ø 6	S Ø 8	D	B	L
W105.190.R	W106.190.R	19	12	65



HW INSERT FLUSH TRIM BITS WITH BALL BEARING GUIDE Z=2

ART. W107 - W108

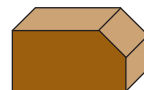
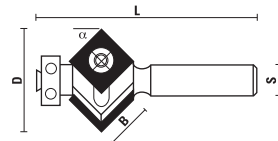

This item is sold complete with a torx key

S Ø 6	S Ø 8	D	α	B	L (W107)	L (W108)
W107.220.R	W108.220.R	22	10°	12	55	70
W107.240.R	W108.240.R	24	22°	12	55	70
W107.260.R	W108.260.R	26	30°	12	55	70



W107.290.R	W108.290.R	29	45°	12	55	70
------------	------------	----	-----	----	----	----

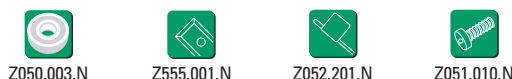

HW INSERT FLUSH BITS Z=2+1

ART. W109 - W110

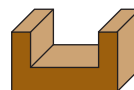
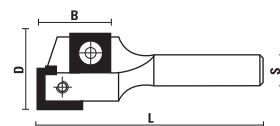

- With T.C.T. plunging edge
- This item is sold complete with a torx key

S Ø 6	S Ø 8	D	B	L
W109.160.R		16	20	50
	W110.160.R	16	20	70
W109.180.R	W110.180.R	18	20	50
W109.200.R	W110.200.R	20	20	50
W109.220.R	W110.220.R	22	20	50



HW INSERT FLUSH BITS Z=2+1

ART. W111 - W112

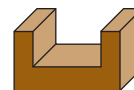
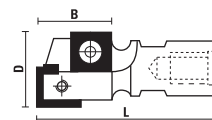

- With T.C.T. plunging edge
- This item is sold complete with a torx key

S M12x1	S M10x1,5	D	B	L
W111.150.R	W112.150.R	15	20	65
W111.160.R	W112.160.R	16	20	65
W111.180.R	W112.180.R	18	20	65
W111.200.R	W112.200.R	20	20	65
W111.220.R	W112.220.R	22	20	65



INSERT ROUTER BITS

Klein trimming bits with straight cuts are thought for having a clean and well finished edge on laminated and veneered panels. They are subject to continuous security check, cutting tolerance and balancing. While the ball bearing (same diameter of the cutter) acts as a guide to protect the edge, the cutter will obtain a perfect and smooth work. Designed and manufactured to allow precise cutting and good chipping ejection.

HW INSERT FLUSH TRIMMING BITS Z=2

ART. W113 - W114 - WG114

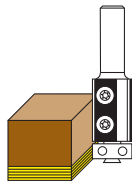
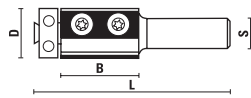

- Lower ball bearing
- This item is sold complete with a torx key



S Ø 8	S Ø 12	S Ø 1/2" (12,7)	D	B	L
W113.160.R			16	30	70
W113.190.R			19	30	70
	W114.190.R		19	30	80
	W114.191.R		19	50	100
	WG114.190.R		19	30	80
	WG114.191.R		19	50	100



Z055.908.N
(B=30)



Z555.010.N
(B=50)



Z050.004.N
(D=16)



Z050.006.N
(D=19)



Z052.201.N



Z051.017.R
(for ball bearing)



Z051.010.R
(for knives)

HW INSERT FLUSH TRIMMING BITS WITH LOWER DOUBLE BALL BEARINGS Z=2

ART. W114

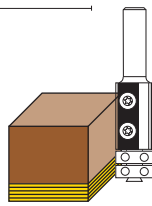
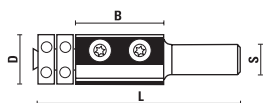

- Double ball bearings for more precise trimming results
- This item is sold complete with a torx key



S Ø 12	D	B	L
W114.192.R	19	50	100



Z555.010.N



Z050.006.N



Z052.201.N



Z051.017.R
(for ball bearing)



Z051.010.R
(for knives)

HW INSERT FLUSH TRIMMING BITS Z=2

ART. W115 - W116 - WG116

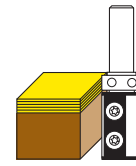
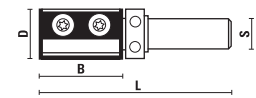

- Upper ball bearing
- This item is sold complete with a torx key

S Ø 8	S Ø 12	S Ø 1/2" (12,7)	D	B	L
W115.190.R			19	30	70
	W116.190.R		19	30	80
	W116.191.R		19	50	100
	WG116.190.R		19	30	80
	WG116.191.R		19	50	100



Z555.008.N.N
(B=30)



Z555.010.N
(B=50)



Z050.012.N



Z052.201.N



Z051.017.R
(for ball bearing)



Z051.010.R
(for knives)

HW INSERT FLUSH TRIMMING BITS WITH UPPER DOUBLE BALL BEARINGS Z=2

ART. W116

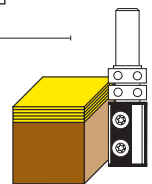
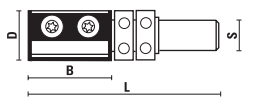

- Double ball bearings for more precise trimming results
- This item is sold complete with a torx key



S Ø 12	D	B	L
W116.192.R	19	50	100



Z555.010.N



Z050.012.N



Z052.201.N



Z051.010.R

HW INSERT FLUSH TRIMMING BITS WITH UPPER ANF LOWER BALL BEARINGS Z=2

ART. W117 - W118 - WG118

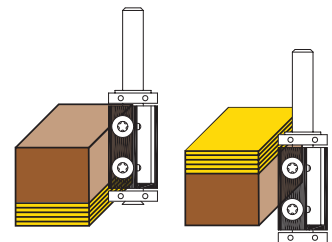
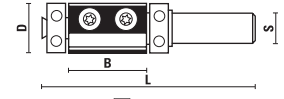

- Suitable for trimming with template on the upper and/or lower side
- This item is sold complete with a torx key



S Ø 8	S Ø 12	S Ø 1/2" (12,7)	D	B	L
W117.190.R			19	30	85
	W118.191.R		19	50	110
	WG118.191.R		19	50	105



Z555.008.N.N
(B=30)



Z555.010.N
(B=50)



Z050.006.N
(lower ball bearing)



Z050.012.N
(upper ball bearing)



Z052.201.N



Z051.017.R
(for ball bearing)



Z051.010.R
(for knives)

VERSOFIX CUTTERS AND KNIVES

The best single flute replaceable tip straight cutters

The **VERSOFIX** tools and relating replaceable tips, due to their special design, give excellent result in high volume production and are suitable for use in all types of machines.

The insert knives are treated with a special coating ensuring the possibility to work also tough materials, i.e. laminated worktops or glass-reinforced plastic panels.

In the solid wood working there isn't any better solution when working with cutters with small shank diameter (Ø8, Ø10, Ø12).

The "**Kawedur**" coating ensures a better chip flow and makes the life of the knives minimum twice longer than any other type of coating (TIN/TIC).

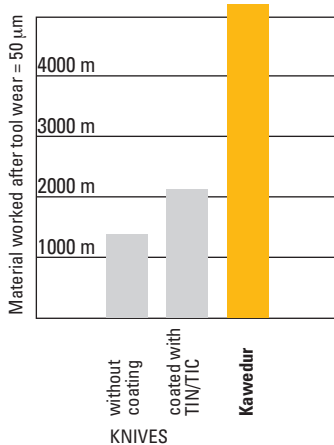
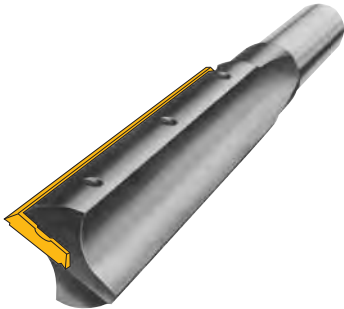

WORKING:
melamine coated chipboard

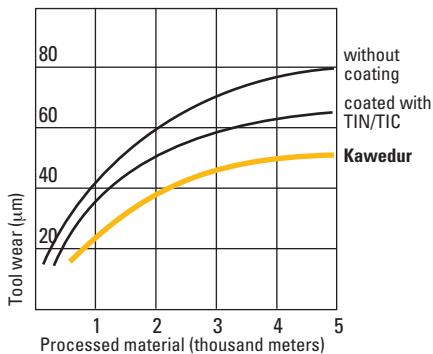

WORKING PARAMETERS:

RPM n=18.000
Cutting speed vs=14,5 m/sec
Feed speed vf=6 m/min

HW INSERT PLUNGE ROUTER BITS Z=1 "VERSOFIX"

ART. W122

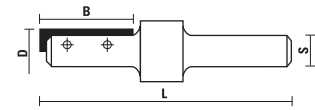

- HW knives with "Kawedur" coating
- This item is sold complete with a torx key



S Ø 8	D	B	L
W122.080.R	8	20	63
W122.100.R	10	20	63
W122.120.R	12	20	63
W122.140.R	14	30	74
W122.150.R	15	30	74
W122.160.R	16	30	74
W122.180.R	18	30	74
W122.200.R	20	30	74
W122.220.R	22	30	74



Z052.101.N



Z052.102.N (For D=14÷22)



Z055.220.N (For D=8÷12)
Z055.231.N (For D=14÷22)



Z051.102.R (For D=14÷22)

HW INSERT PLUNGE ROUTER BITS Z=1 "VERSOFIX"

ART. W123 - W124

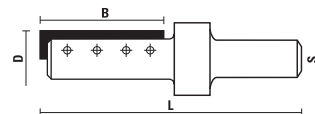

- HW knives with "Kawedur" coating
- This item is sold complete with a torx key



S Ø 10x35	S Ø 12x35	D	B	L
W123.080.R	W124.080.R	8	20	68
W123.100.R	W124.100.R	10	20	68
W123.120.R	W124.120.R	12	20	68
	W124.140.R	14	30	74
W123.141.R	W124.141.R	14	50	94
	W124.150.R	15	30	74
	W124.160.R	16	30	74
W123.161.R	W124.161.R	16	50	94
	W124.180.R	18	30	74
W123.181.R	W124.181.R	18	50	94
	W124.200.R	20	30	74
W123.201.R	W124.201.R	20	50	94
	W124.220.R	22	30	74



Z052.101.N



Z052.102.N (For D=14÷22)



Z055.220.N (For D=8÷12)
Z055.231.N (For D=14÷22)
Z055.250.N (For D=14÷22)



Z051.102.R (For D=14÷22)

HW INSERT PLUNGE ROUTER BITS Z=1 "VERSOFIX"

ART. W126 - W127

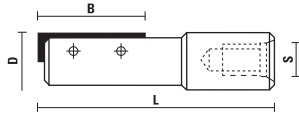

- HW knives with "Kawedur" coating
- This item is sold complete with a torx key



S M10x1,5	S M12x1	D	B	L
W126.141.R	W127.141.R	14	50	85
W126.161.R	W127.161.R	16	50	85
W126.181.R	W127.181.R	18	50	85
W126.201.R	W127.201.R	20	50	85



Z055.250.N (For D=14÷22)



Z051.102.R (For D=14÷22)



Z052.102.N (For D=14÷22)

HW INSERT FLUSH TRIM BITS Z=2 "VERSOFIX"

ART. W138

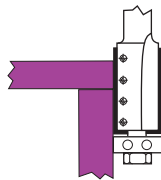
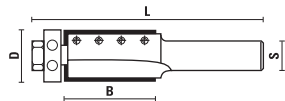

- HW knives with "Kawedur" coating
- For CORIAN®
- Ball bearing with Delrin® ring
- This item is sold complete with a torx key



S Ø 12	D	B	L
W138.190.R	19	30	82



Z050.111.N



Z055.230.N



Z051.101.R



Z052.101.N

HW INSERT FLUSH TRIM BITS Z=2 "VERSOFIX"

ART. W138

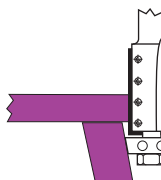
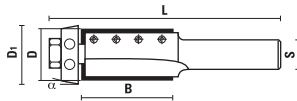

- HW knives with "Kawedur" coating
- For CORIAN®
- 11° ball bearing with Delrin® ring
- This item is sold complete with a torx key



S Ø 12	D	D1	B	L	α
W138.220.R	19	22	30	82	11°



Z050.110.N



Z055.230.N



Z051.101.R



Z052.101.N

HW INSERT BORING BITS Z=2+2

ART. W140

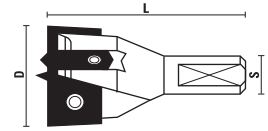

- This item is sold complete with a torx key



RH rotation	LH rotation	D	L	S	Spare knife
W140.250.R	W140.250.L	25	57	10x26	Z055.125.N
W140.260.R	W140.260.L	26	57	10x26	Z055.126.N
W140.300.R	W140.300.L	30	57	10x26	Z055.130.N
W140.350.R	W140.350.L	35	57	10x26	Z055.135.N
W140.400.R	W140.400.L	40	57	10x26	Z055.140.N



Z051.010.R
Screw for knives



Z051.011.R
Screw for spurs



Z051.304.R
Screw for centre point



Z055.100.N



Z055.101.N



Z052.201.N

HW INSERT PLUNGE ROUTER CUTTERS Z=1

ART. W155

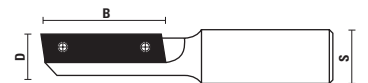

- Spare knives suitable for plunging
- This item is sold complete with a torx key



Item	D	B	S	Z
W155.161.R	16	50	Ø20x50	1
W155.181.R	18	50	Ø20x50	1
W155.200.R selling out	20	30	Ø20x50	1
W155.201.R	20	50	Ø20x50	1
W155.220.R selling out	22	30	Ø20x50	1
W155.221.R	22	50	Ø20x50	1



Z055.423.N (B=30 D=16)
Z055.425.N (B=50 D=16)
Z055.430.N (B=30)
Z055.450.N (B=50)



Z051.210.R (B=30)



Z051.211.R (B=50)



Z052.201.N

HW INSERT COMPRESSION ROUTER CUTTERS

ART. W165

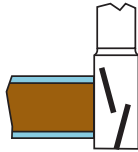
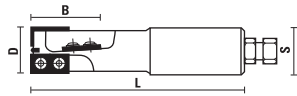

- Axial angle positive and negative compression bits
- HW plunging tip
- This item is sold complete with a torx key



Item	D	B	L	S	Z
W165.201.R	20	50	125	25x55	2+2+1
W165.202.R	20	30	134	MK2 - M 30x1,5	2+2+1
W165.203.R	20	50	157	MK2 - M 30x1,5	2+2+1



Z051.308.R



Z052.302.N



Z055.516.N (B=30)
Z055.528.N (B=50)

HW INSERT COMPRESSION ROUTER CUTTERS

ART. W165

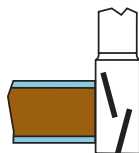
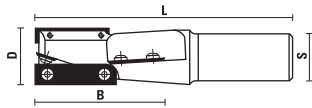

- Axial angle positive and negative compression bits
- With spare knife for plunging
- This item is sold complete with a torx key



Item	D	B	L	S	Z
W165.300.R	30	75	145	25x55	2+2+1



Z051.210.R



Z052.201.N



Z055.341.N



Z555.000.N

HW INSERT ROUTER BITS FOR CABINET DOORS Z=2

ART. W160

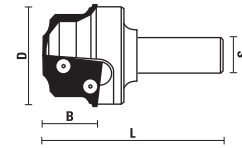

PROFILE A1

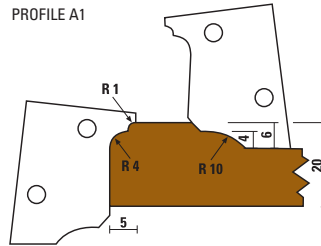

PROFILE A2

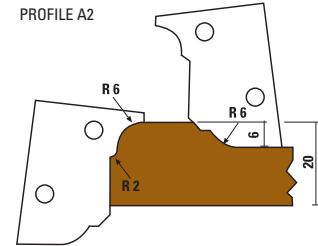

PROFILE A3

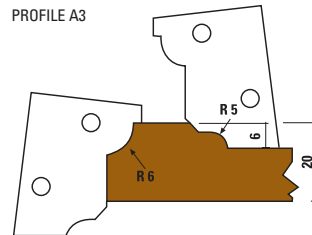

PROFILE A4

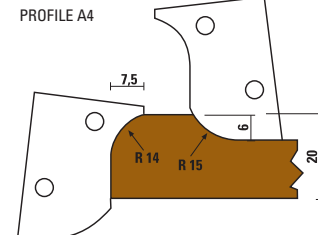

PROFILE A5

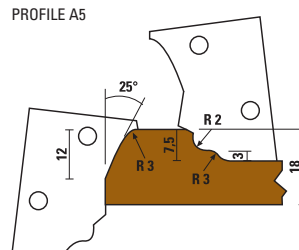

PROFILE A6

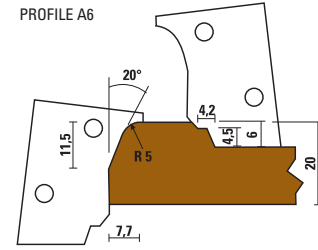

- With reversible knives
- For producing either the external or internal moulding
- This item is sold complete with a torx key



Item	D	B	L	S	Profile
W160.601.R	50	40	115	20x50	A1
W160.602.R	50	40	115	20x50	A2
W160.603.R	50	40	115	20x50	A3
W160.604.R	50	40	115	20x50	A4
W160.605.R	50	40	115	20x50	A5
W160.606.R	50	40	115	20x50	A6

Spare parts

Tool body without knives

W160.600.R



Z051.010.R



Z055.661.R (A1)
Z055.662.R (A2)
Z055.663.R (A3)
Z055.664.R (A4)
Z055.665.R (A5)
Z055.666.R (A6)



Z052.201.N

HW INSERT ROUTER BITS FOR CABINET DOORS Z=2

ART. W161

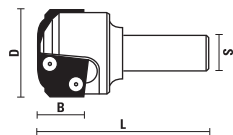

PROFILE B1

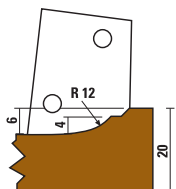

PROFILE B2

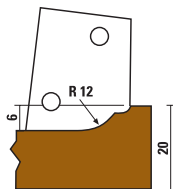

PROFILE B3

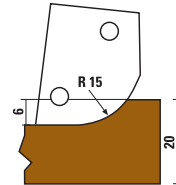

PROFILE B4

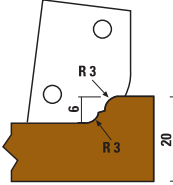

PROFILE B5

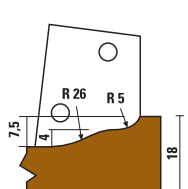

PROFILE B6

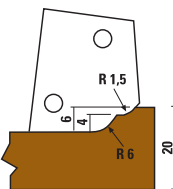

- With reversible knives
- For producing the internal moulding
- This item is sold complete with a torx key



Item	D	B	L	S	Profile
W161.501.R	52	25	90	20x50	B1
W161.502.R	52	25	90	20x50	B2
W161.503.R	52	25	90	20x50	B3
W161.504.R	52	25	90	20x50	B4
W161.505.R	52	25	90	20x50	B5
W161.506.R	52	25	90	20x50	B6

Spare parts

Tool body without knives

W161.500.R



Z051.010.R



Z055.651.R (B1)
Z055.652.R (B2)
Z055.653.R (B3)
Z055.654.R (B4)
Z055.655.R (B5)
Z055.656.R (B6)



Z052.201.N

HW INSERT ROUTER BITS FOR DECORATION AND ENGRAVING Z=1

ART. W162

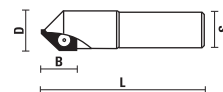

PROFILE C1

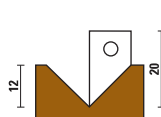

PROFILE C2

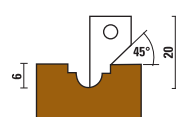

PROFILE C3

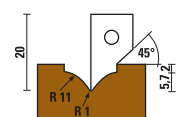

PROFILE C4

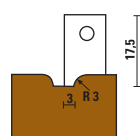

PROFILE C5

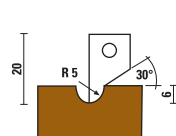

PROFILE C6

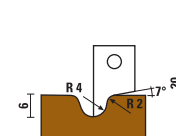

PROFILE C7

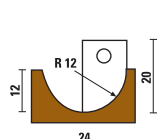

PROFILE C8

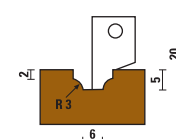

PROFILE C9

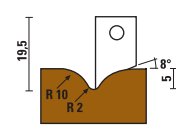

PROFILE C10

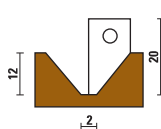

- With reversible knives
- This item is sold complete with a torx key



Item	D	B	L	S	Profile
W162.241.R	24	20	95	20x50	C1
W162.242.R	24	20	95	20x50	C2
W162.243.R	24	20	95	20x50	C3
W162.244.R	24	20	95	20x50	C4
W162.245.R	24	20	95	20x50	C5
W162.246.R	24	20	95	20x50	C6
W162.247.R	24	20	95	20x50	C7
W162.248.R	24	20	95	20x50	C8
W162.249.R	24	20	95	20x50	C9
W162.250.R	24	20	95	20x50	C10

Spare parts

Tool body without knives

W162.240.R



Z051.021.R



Z055.641.R (C1)
Z055.642.R (C2)
Z055.643.R (C3)
Z055.644.R (C4)
Z055.645.R (C5)
Z055.646.R (C6)
Z055.647.R (C7)
Z055.648.R (C8)
Z055.649.R (C9)
Z055.650.R (C10)



Z052.201.N

COMPLETE SET FOR DECORATING AND ENGRAVING

ART. XW162

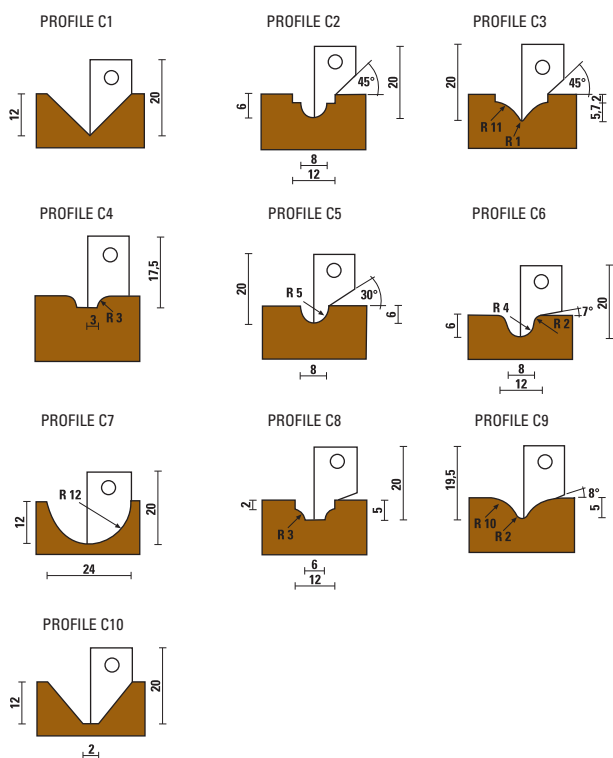

- Set includes a tool body with nr. 10 profiled knives
- With reversible knives
- Z=1
- In plastic case



Item

XW162.001.N

complete with:

W162.250.R

Spare knife	Dimension	Profile
Z055.641.R	45°	C1
Z055.642.R	R4/45°	C2
Z055.643.R	R1/R11	C3
Z055.644.R	R3	C4
Z055.645.R	R8/30°	C5
Z055.646.R	R4/R2	C6
Z055.647.R	R12	C7
Z055.648.R	R3/2	C8
Z055.649.R	R2/R10	C9
Z055.650.R	45°/2	C10



Z051.010.R



Z052.201.N

COMPLETE CUTTERS SET FOR CABINET DOORS

ART. XW160



Set including 3 cutters with HW knives and torx key

PROFILE EXAMPLES

Item

XW160.001.N including: W160.601.R + W161.501.R + W162.250.R + Z052.201.N

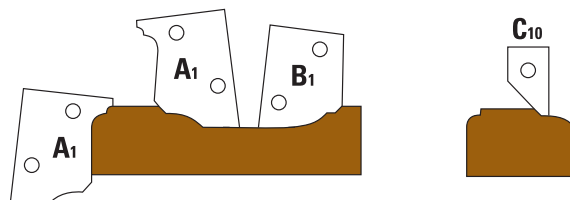

Item

XW160.002.N including: W160.602.R + W161.502.R + W162.250.R + Z052.201.N

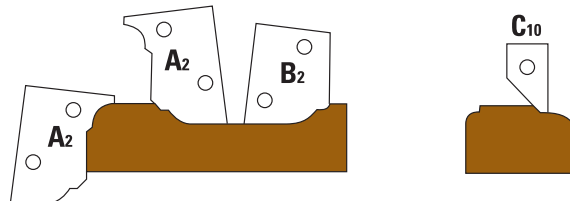

Item

XW160.003.N including: W160.603.R + W161.503.R + W162.250.R + Z052.201.N

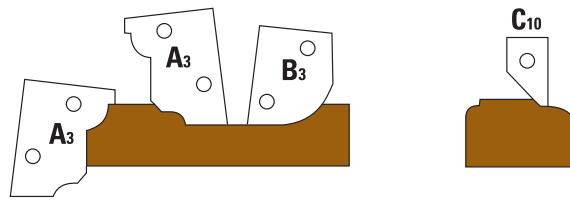

Item

XW160.004.N including: W160.605.R + W161.505.R + W162.250.R + Z052.201.N

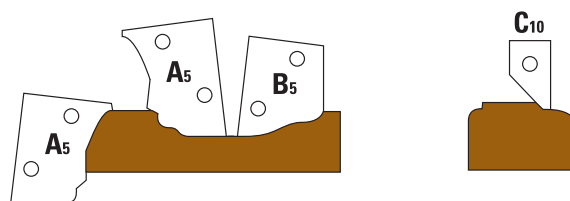

Item

XW160.005.N including: W160.606.R + W161.506.R + W162.250.R + Z052.201.N

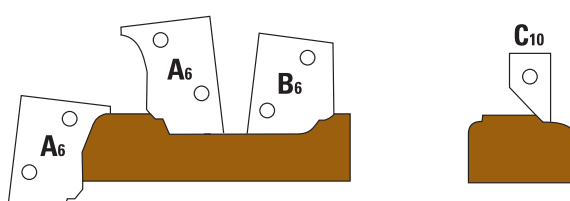

PROFILE EXAMPLE

Item **W160**

Execution nr. 1 and 2

Working with the same cutter you can produce either the external (nr. 1 - routing) or internal (nr. 2 - profiling) profile

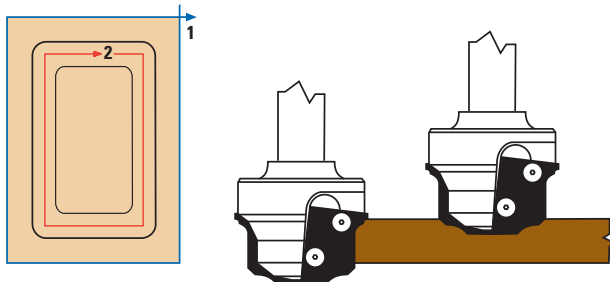

Item **W161**

Execution nr. 3

Profiling the internal side

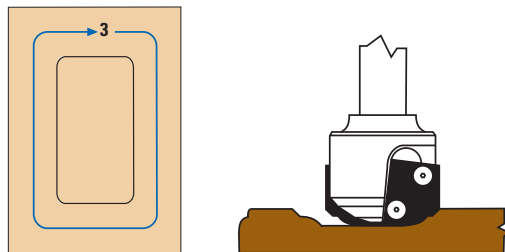

Item **W162**

Execution nr. 4 and 5

This cutter is used to work the decoration on top and can be used with different profiled knives

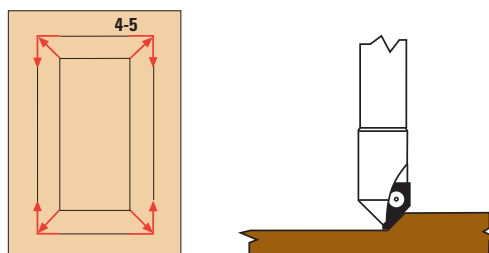

HW INSERT VARI-ANGLE ROUTER CUTTERS Z=2

ART. **W168**

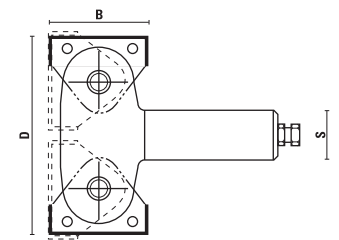

- Adjustable 0° - 45° top
- Adjustable 0° - 90° bottom
- Adjustable by 7,5 degree
- This item is sold complete with a torx key



Item	D	B	Z	S
W168.085.R	85	40	2	25x55
W168.185.R	85	40	2	20x55



Z056.765.N



Z056.791.N



Z555.340.N



Z051.408.R
Z051.409.R



Z052.103.N
Z052.104.N

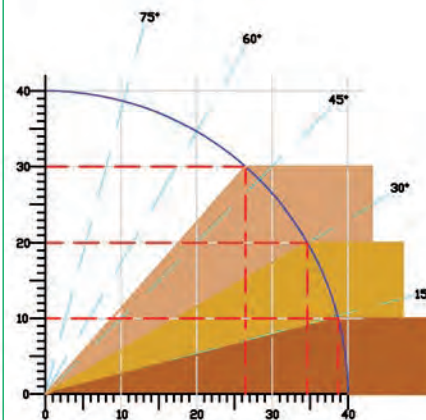
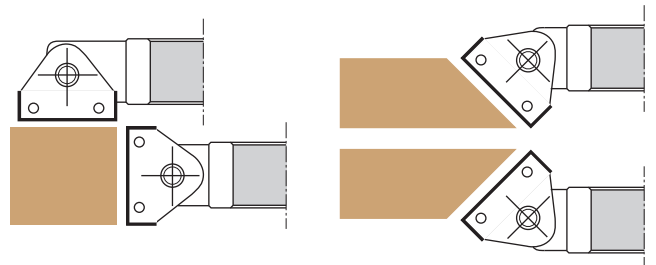

HW INSERT ROUTER BITS FOR ENGRAVINGS Z=1

ART. W170

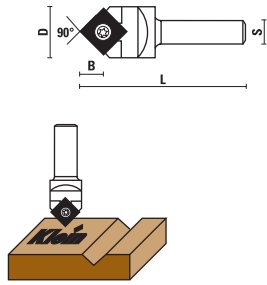

This item is sold complete with a torx key



S \varnothing 12	D	B	L	Z
W170.170.R	17	8,4	60	1

- Z051.212.R
- Z052.201.N
- Z555.001.N

HW INSERT ROUTER BITS FOR ENGRAVINGS Z=1

ART. W170

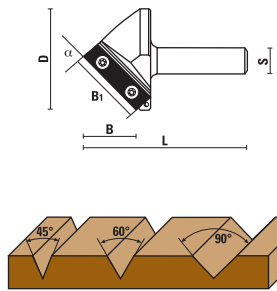

This item is sold complete with a torx key



S \varnothing 12	D	α	B	B1	L
W170.210.R	21	45°	25	27	61
W170.260.R	26	60°	23	27	61
W170.380.R	38	90°	19	27	76

- Z051.212.R
- Z052.201.N
- Z055.506.N
(45°-60°)
- Z055.507.N
(90°)



HW INSERT V-GROOVE ROUTER BITS Z=1

ART. W171

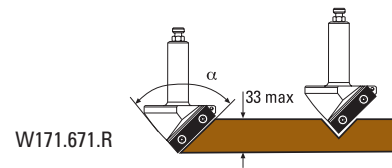
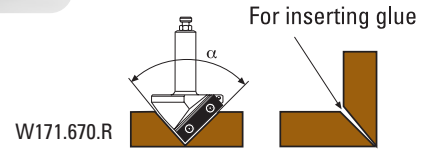
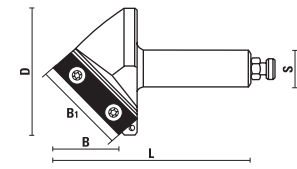

This item is sold complete with a torx key



Item	D	α	B	B1	L	S
W171.670.R	67	91°	33	46,5	97	20
W171.671.R	67	90°	33	46,5	97	20

- Z051.402.R
- Z052.201.N
- Z055.505.N

HW INSERT V-GROOVE ROUTER BITS Z=1 FOR PLASTIC KleinDIA COATED

ART. W171.UKD

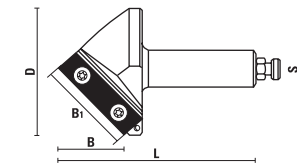

UP TO 4/6X TOOL LIFE



- Special grinding quality of the knives for working plastic with a better evacuation
- Coated insert knife for improved chip evacuation and less friction for excellent performance
- This item is sold complete with a torx key



RH rotation	D	α	B	B1	L	S
W171.670.RUKD	67	91°	33	46,5	97	20
W171.671.RUKD	67	90°	33	46,5	97	20

- Z051.402.R
- Z052.201.N
- Z055.505.NKD

HW INSERT ROUTER BITS FOR LOCKS Z=2

ART. W172 - W173

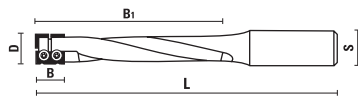

- Used on CNC routers and machining centres
- This item is sold complete with a torx key



Item	D	B	B ₁	L	S
W172.160.R	16	16	115	170	16x55
W172.161.R	16	23	105	150	16x45
W172.180.R*	18	16	115	170	16x55
W173.161.R	16	23	115	170	20x55

*Selling out



Z051.328.R



Z052.302.N



Z055.501.N
Z055.502.N
(16x7x1,5)



Z055.503.N
Z055.504.N
(23x7x1,5)

HW INSERT ROUTER BITS FOR LOCKS Z=2 HEAVY METAL TOOL BODY

ART. W172

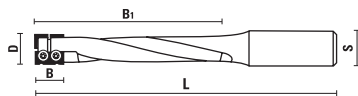

- Used on CNC routers and machining centres
- Heavy metal tool body
- Low-vibration machining
- Reduced risk of tool breakage
- This item is sold complete with a torx key



Item	D	B	B ₁	L	S
W172.160.RAP	16	16	115	170	16x55



Z051.308.R



Z052.302.R



Z055.501.N
Z055.502.N

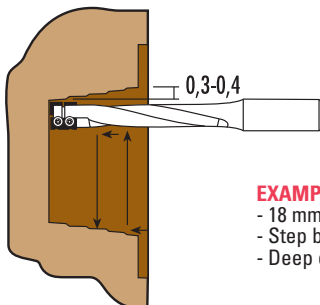

EXAMPLE OF USE:

- 18 mm: n. 12.000-20.000 min⁻¹
- Step by step cutting 0,3-0,4 mm
- Deep cutting with excellent chip flow

HW INSERT ROUTER BITS Z=3

ART. W174 - W175

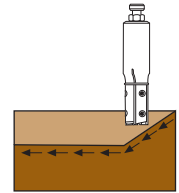
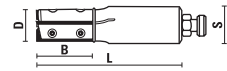

- Extremely silent
- Improved balancing compared with traditional system
- Used on CNC routers and machining centres
- **NO CUTTING EDGE FOR BORING**
- This item is sold complete with a torx key



Item	Rotat.	D	B	L	S
W174.180.R	Rh	18	50	102	20



Z051.404.R



Z052.007.N



Z055.500.R
Z055.500.L

HW INSERT ROUTER BITS FOR PLANING AND RABBETING Z=2+2

ART. W176 - W177

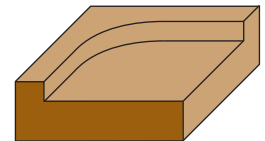
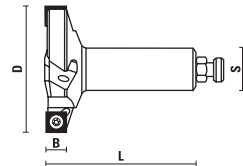

- Ideal for removing material over large surface areas
- Used on CNC routers and machining centres
- This item is sold complete with a torx key



Item	D	B	L	S
W176.800.R	80	12	90	20
W177.800.R	80	12	90	25



Z051.402.R



Z051.403.R



Z052.201.N



Z555.001.N
knife



Z555.007.N
spur

HW INSERT ROUTER CUTTERS, ROUGHING Z=4

ART. W179

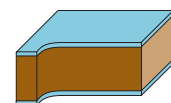
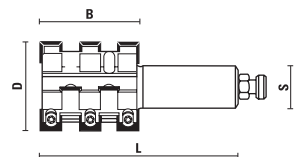

- Multi cutting flutes router cutter 12x12x1,5
- Used on CNC routers and machining centres
- This item is sold complete with a torx key



Item	D	B	L	S	Z
W179.500.R	50	56	113	25	4
W179.501.R	50	78	135	25	4



Z051.400.R



Z052.201.N



Z555.001.N

HW INSERT ADJUSTABLE ROUTER CUTTERS FOR GROOVING

ART. W183

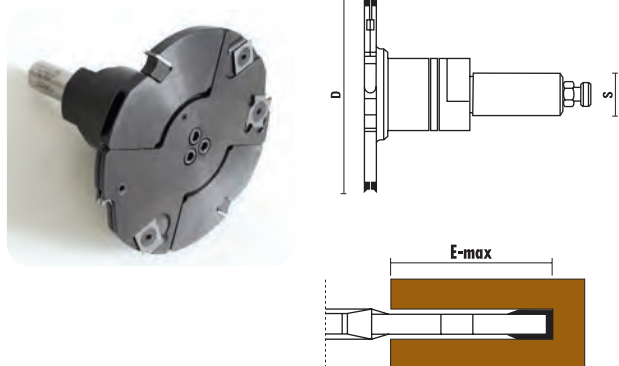

- Suitable for producing different thickness grooves
- Thickness adjustable in 0,1 mm steps by means of spacers
- Used on CNC routers and machining centres
- Can be produced with HSK or ISO30 shank on request
- This item is sold complete with a torx key



Item	D	B	L	S	E-max
W183.120.R	120	4÷15,5	140	25	33
Z051.405.R	Z051.406.R	Z555.006.N (2)	Z555.000.N (4)	Z057.100.N	Z055.020.N (4)
Z052.006.N	Z052.302.N	Z060.750.N	Z060.751.N	Z056.102.N	

HW INSERT ROUTER BIT FOR HUNDEGGER

ART. W187

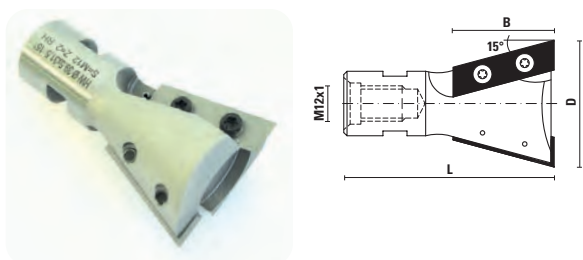

- This item is sold complete with a torx key



Item	D	B	L	α	Z	S
W187.395.R	39,5	31,5	65,5	15°	2	M12x1
Z055.512.N	Z052.201.N	Z051.027.N				

HW INSERT ROUTER BITS FOR PLANING AND RABBETING

ART. W190 - WC190 - WE190 - WG190

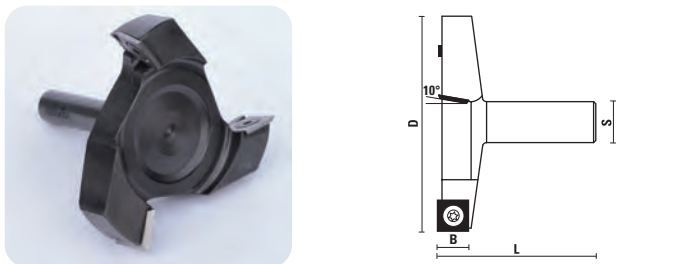

10° shear angle

- Used for **surfacing MDF and particle board** and making deep rabbet
- **10° shear angle** for better performance
- Suitable for processing ever kind of wood
- To be used on machining centres and CNC routers
- Item WE190.380.R and WC190.350.R are suitable for working with electric portable machines
- Right-hand rotation
- For greater performance PCD knives can be mounted
- This item is sold complete with a torx key



Item	D	B	L	Z	S
W190.100.R	100	14	80	3	20x55
W190.101.R	4"	14	3"	3	3/4"x55
Z051.205.R	Z555.007.N	Z052.205.N			

Item	D	B	L	Z	S
WE190.800.R	80	14	76	3	12x50
Z051.020.R	Z555.007.N	Z052.103.N			

Item	D	B	L	Z	S
WE190.635.R	63,5	14	70	3	12x45
WG190.635.R	2-1/2"	14	2-3/4"	3	1/2"x45
Z051.020.R	Z555.007.N	Z052.103.N			

Item	D	B	L	Z	S
WE190.380.R NEW	38	12	60	3	12
Z051.210.R	Z555.001.N	Z052.201.N			

Item	D	B	L	Z	S
WC190.350.R NEW	35	10,5	60	3	8
Z051.210.R	Z055.016.N	Z052.201.N			

HW INSERT ROUTER BITS FOR PLASTIC MATERIAL

ART. W190.RU – WE190.RU – WG190.RU

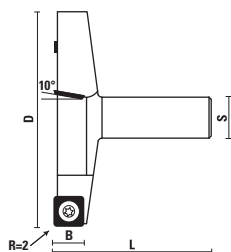

10° shear angle

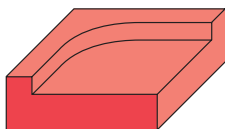
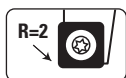

- Used for **surfacing plastic board material** and making deep rabbet (also known as Flycutters - Spoilboard cutters)
- Special insert knives with radius (R=2) for smoother cuts and no risk of marks and scratch.
- **10° shear angle** for better performance
- To be used on machining centres and CNC routers
- Right-hand rotation
- This item is sold complete with a torx key



Item	D	B	L	Z	S
W190.100.RU	100	14	80	3	20x55
W190.101.RU	4"	14	3"	3	3/4"x55



Z051.205.R



Z055.107.N



Z052.205.N

Item	D	B	L	Z	S
WE190.800.RU	80	14	76	3	12x50



Z051.020.R



Z055.107.N



Z052.103.N

Item	D	B	L	Z	S
WE190.635.RU	63,5	14	70	3	12x45
WG190.635.RU	2-1/2"	14	2-3/4"	2	1/2"x45



Z051.020.R



Z055.107.N



Z052.103.N

Item	D	B	L	Z	S
WE190.380.RU NEW	38	12	60	3	12



Z051.210.R



Z055.104.N



Z052.201.N

HW INSERT SPOILBOARD CUTTER INTEGRATED WITH HSK-63F

ART. W190

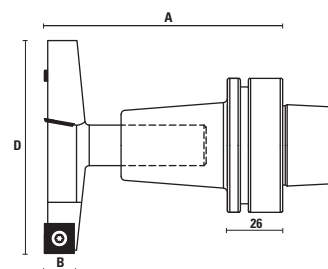

- Suitable for surfacing spoilboard on CNC
- Best accuracy and precision
- Balanced at G 2,5 to 24.000 RPM
- This item is sold complete with a torx key



Item	Taper	D	B	A	Z
W190.100.RHSK63F	HSK-63F	100	14	116	3
W190.101.RHSK63F	HSK-63F	4"	14	112	3

Spare parts: Router bit
W190.100.R

Spare parts: Collet chucks
T120.700.N For W190.100.RHSK63F

Spare parts: Router bit
W190.101.R

Spare parts: Collet chucks
T120.695.N For W190.101.RHSK63F



Z555.007.N



Z052.205.N



Z051.205.R

VISIT OUR WEBSITE
www.sistemiklein.com



INSERT ROUTER BITS FOR PORTABLE ROUTERS

Always looking for innovative products and most useful solutions, **SISTEMI** has developed a new line of router bits **Klein** with interchangeable carbide knives, which have a higher hardness than the tips used in traditional brazed router bits.

The main advantages granted by the use of HM reversible knives and the possibility of their easy replacement are:

- **Longer tool life** ⇒ the knives are getting less worn out and in case of damage they can be easily replaced;
- **Better finish quality** ⇒ also working abrasive materials, the cutting edge can be maintained always sharp;
- **Higher measures precision** ⇒ the dimensions of the tools are not changing because there is no resharping;
- **Better Quality/Price ratio** ⇒ higher production efficiency, less costs and better performances.

HW INSERT FLUSH TRIMMING BITS Z=1

ART. WC101

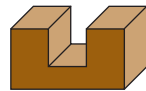
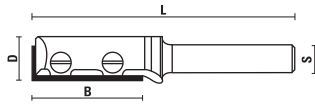

With reversible knives

S ∅ 8	D	B	L
WC101.120.R	12	29,5	66
Z055.330.N	Z051.501.R		

HW INSERT V-GROOVING BITS Z=1

ART. WC109

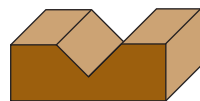
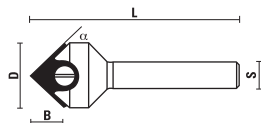

With reversible knives

S ∅ 8	D	B	α	L
WC109.176.R	17,6	8,5	45°	53
Z055.001.N	Z051.501.R			

HW INSERT CORE BOX BITS WITH UPPER BALL BEARING Z=1

ART. WC111

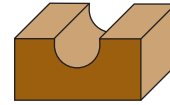
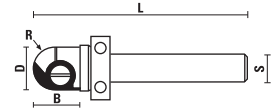

With reversible knives

S ∅ 8	D	B	R	L
WC111.127.R	12,7	13	6	59
Z050.018.N	Z055.550.N	Z051.501.R		

HW INSERT FLUSH TRIMMING BITS WITH BALL BEARING

ART. WC120

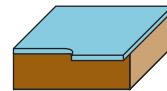
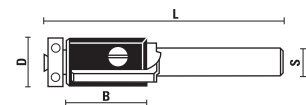

With reversible knives

S ∅ 8	D	B	L	Z
WC120.127.R	12,7	20	62	2
Z050.003.N	Z055.551.N	Z051.503.N	Z051.501.R	
		Screw for ball bearing	Screw for knives	

HW INSERT FLUSH TRIMMING BITS WITH BALL BEARING Z=2

ART. WC121

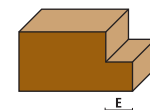
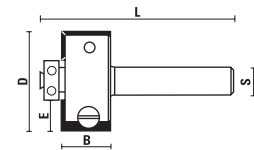

With reversible knives

S ∅ 8	D	B	E	L
WC121.286.R	28,6	13,2	7,95	48
Z050.002.N	Z055.552.N	Z051.503.N	Z051.501.R	
		Screw for ball bearing	Screw for knives	

HW INSERT FLUSH TRIMMING BITS WITH BALL BEARING Z=2

ART. WC122

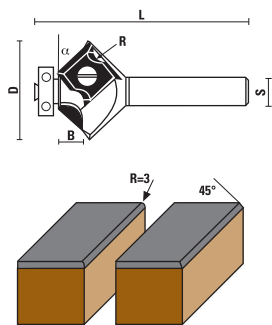

- With reversible knives

- The same knives can be used for both 45° and R= 3 bevel



S Ø 8	D	B	R	α	L
WC122.273.R	27,3	5,7	3	45°	59
Z050.003.N	Z055.553.N	Z051.503.N Screw for ball bearing	Z051.501.R Screw for knives		

HW INSERT CORNER ROUNDING BITS WITH BALL BEARING Z=2

ART. WC123

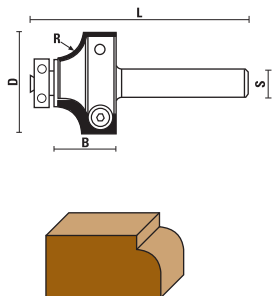

With reversible knives



S Ø 8	D	B	R	L
WC123.260.R	26	15,7	6	55
Z050.003.N	Z055.554.N	Z051.503.N Screw for ball bearing	Z051.501.R Screw for knives	

6 PIECE INSERT ROUTER BITS "SET"

ART. XWC



- Set including the 6 most popular HW router bits in S=8 in a robust and practical wooden box.

- Ideal to have always on hand the right bit for straight cuts, trimming and engraving.

- Router bit with reversible knives

See page 1.35

Item

XWC.001.R

6-pcs router bit set:

WC101.120.R - WC109.176.R

WC111.127.R - WC120.127.R

WC121.286.R - WC122.273.R

HW INSERT COVER BITS WITH BALL BEARING Z=2

ART. WC125

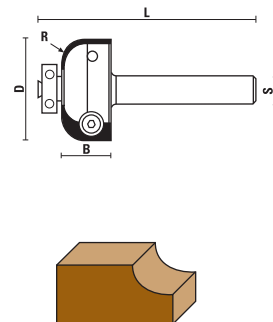

With reversible knives



S Ø 8	D	B	R	L
WC125.260.R	26	12,7	6	55
Z050.003.N	Z055.555.N	Z051.503.N Screw for ball bearing	Z051.501.R Screw for knives	

HW INSERT OGEE BITS WITH BALL BEARING Z=2

ART. WC129

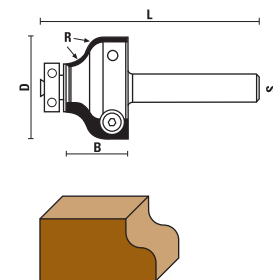

With reversible knives



S Ø 8	D	B	R	L
WC129.260.R	26	15,7	4,5	55
Z050.003.N	Z055.556.N	Z051.503.N Screw for ball bearing	Z051.501.R Screw for knives	

6 PIECE INSERT ROUTER BITS "SET"

ART. XWC



- Set including the 6 most popular HW router bits in S=8 in a robust and practical wooden box.

- Ideal to have always on hand the right bit for trimming and profiling.

- Router bit with reversible knives

See page 1.35

Item

XWC.002.R

6-pcs router bit set:

WC120.127.R - WC121.286.R

WC122.273.R - WC123.260.R

WC125.260.R - WC129.260.R

HW INSERT ROUTER BITS Z=2+1

ART. WE100

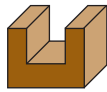
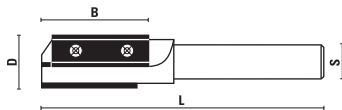

- With HW boring tip
- This item is sold complete with a torx key



S Ø 12	D	B	L
WE100.160.R	16	50	110
WE100.180.R	18	50	110
WE100.200.R	20	50	110
WE100.220.R	22	50	110



Z051.010.R



Z052.201.N



Z055.440.N



Z555.009.N

HW INSERT ROUTER BITS Z=2 WITH STRAIGHT CUTTERS

ART. WE101

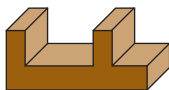
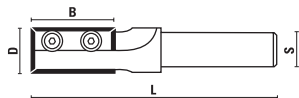

- S=1/2" on request art. WG
- This item is sold complete with a torx key



S Ø 12	D	B	L
WE101.120.R	12	29,5	81



Z051.321.R



Z052.007.N



Z055.529.N

WE101.140.R	14	29,5	86
-------------	----	------	----



Z051.212.R



Z052.201.N



Z555.329.N

WE101.160.R	16	29,5	88
-------------	----	------	----



Z051.211.R



Z052.201.N



Z555.329.N

WE101.180.R	18	29,5	86
-------------	----	------	----

WE101.200.R	20	29,5	86
-------------	----	------	----

WE101.220.R	22	29,5	88
-------------	----	------	----



Z051.400.R



Z052.201.N



Z555.329.N

HW INSERT BALL SLOT ROUTER BITS Z=2

ART. WE112

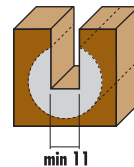
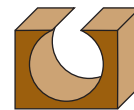
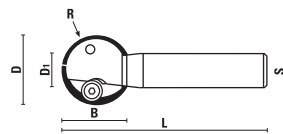

These tools can produce grooves for sliding panels or electrical wires, after a first groove wich allows the tool shank moving

min 11

- S=1/2" on request art. WG
- This item is sold complete with a torx key



S Ø 12	D	D ₁	R	B	L
WE112.127.R	12,7	10	6,4	10	67
WE112.160.R	16	13	8	14	70
WE112.190.R	19	15	9,5	17	67
WE112.254.R	25,4	17	12,7	24	73



Z051.308.R
(D da 12,7 a 19)



Z051.400.R
(D=25,4)



Z052.201.N (Z051.308)
Z052.302.N (Z051.400)



Z055.572.N
Z055.573.N



Z055.574.N
Z055.575.N

HW INSERT REBATE BITS Z=2

ART. WE150

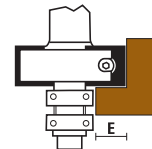
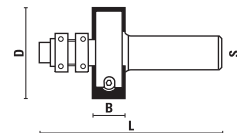

- S=1/2" on request art. WG
- This item is sold complete with a torx key



S Ø 12	D	B	L	E
WE150.380.R	38	12	66	12



Z050.007.N



Z051.400.R



Z052.201.N



Z555.001.N



Z054.410.N



Z054.002.N

HW INSERT RABBETING BITS Z=2

ART. WE150

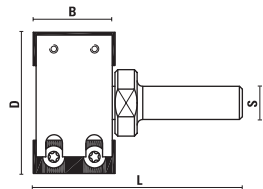

- Suitable for working with FESTOOL® CMS-OF 1010/ BASIS 5A/BASIS 6
- To be used with FESTOOL® Compact Modular System (CMS)
- This item is sold complete with a torx key

S Ø 12	D	B	L	Z
WE150.500.R	50	30	70	2

SPARE PARTS

Rabbeting head

WE150.505.R	50	30	2
-------------	----	----	---

Cutter arbor

E117.130.N	S= Ø12x36
------------	-----------



Z051.010.R



Z052.201.N



Z055.110.N

ASSEMBLY

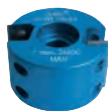

WE150.505.R
Rabbeting head



E117.130.R
Cutter arbor

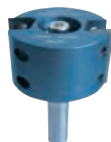

WE150.500.R

HW INSERT REBATE BITS Z=2

ART. WE150

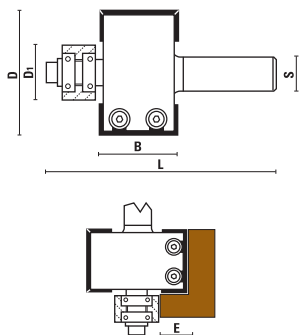

This item is sold complete with a torx key

- This item is sold complete with a guide collar D=19 mm (our item Z050.903.N) to obtain rabbet width of E=16 mm.
- S=1/2" on request art. WG

S Ø 12	D	B	L	E
WE150.510.R	51	29,5	84	16



Z050.007.N



Z051.400.R



Z052.201.N



Z555.329.N



Z054.410.N



Z054.002.N

BEARING RINGS

D1	E	BEARING RINGS	D1	E	
Z050.901.N	14,31	18,25	Z050.909.N	31,8	9,5
Z050.902.N	16	17,5	Z050.910.N	32,5	9,25
Z050.903.N	19	16	Z050.911.N	35	8
Z050.904.N	20,6	15,2	Z050.912.N	38	6,4
Z050.905.N	22,2	14,3	Z050.913.N	39	6
Z050.906.N	25,4	12,7	Z050.914.N	41,3	4,8
Z050.907.N	27	12	Z050.915.N	44,4	3,2
Z050.908.N	28,6	11,1	Z050.916.N	47,6	1,6

Z050.999.N set complete with 16 bearing rings

HW INSERT PROFILE RAISED PANEL ROUTER CUTTERS Z=2

ART. WE178

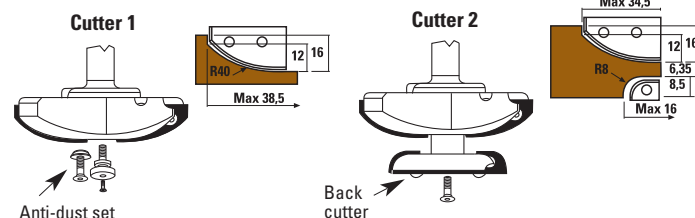
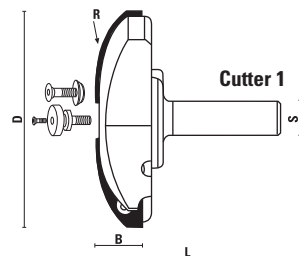

- S=1/2" on request art. WG
- This item is sold complete with a torx key



S Ø 12	D	R	B	L
WE178.860.R - Cutter 1	86	40	21,2	72
WE178.870.R - Cutter 2	86	40	21,2	72

(Complete with back cutter)



Z051.050.N



Z051.400.R



Z051.050.R



Z052.201.N



Z055.560.N

WE178.999.R - Back cutter	Ø=54x26,7
---------------------------	-----------



Z051.308.R



Z052.302.N



Z055.569.N

HW INSERT PROFILE RAISED PANEL ROUTER CUTTERS Z=2

ART. WE178

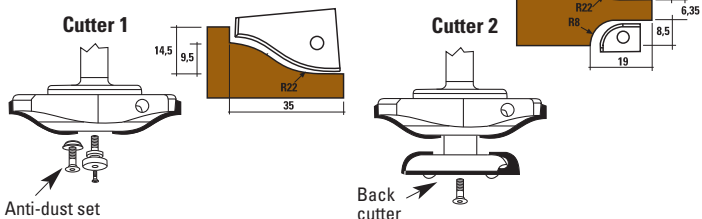
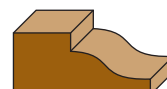
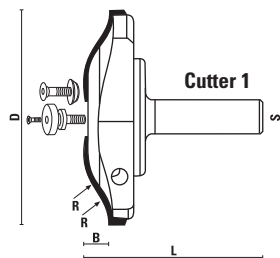

- S=1/2" on request art. WG
- This item is sold complete with a torx key



S Ø 12	D	R	B	L
WE178.862.R - Cutter 1	86	22	19	69
WE178.872.R - Cutter 2	86	22	19	69

(Complete with back cutter)



Z051.050.N



Z051.400.R



Z051.050.R



Z052.201.N



Z055.562.N

WE178.999.R - Back cutter	Ø=54x26,7
---------------------------	-----------



Z051.308.R



Z052.302.N



Z055.569.N

HW INTERCHANGEABLE INSERT ROUTER BITS "NOVA SYSTEM" Z=2

ART. W200 - W201

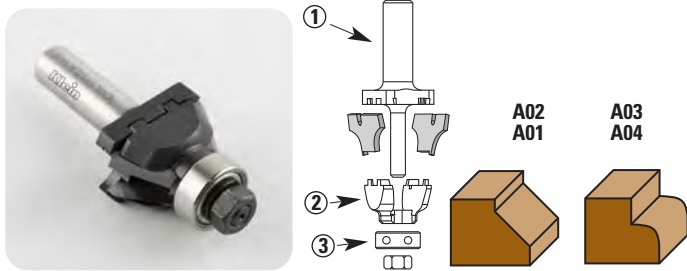

- Replaceable carbide tips
- Patent pending # 129720
- These tools have been checked by the BIA



S Ø 8	S Ø 12	D	α	R	Spare inserts
W200.350.C	W200.350.E	35	30°		W200.A01
W200.380.C	W200.380.E	38	45°		W200.A02
W201.350.C	W201.350.E	35		3,2	W201.A03
W201.351.C	W201.351.E	35		4,8	W201.A04 Spare

SPARE PARTS

1) Arbor

W200.000.C W200.000.E

2) Safety shield

W201.001.N

3) Ball bearing

Z050.005.N - Ø19/Ø6,4 x 7,1 mm

HW INTERCHANGEABLE INSERT ROUTER BITS "NOVA SYSTEM" Z=2

ART. W206 - W207 - W208

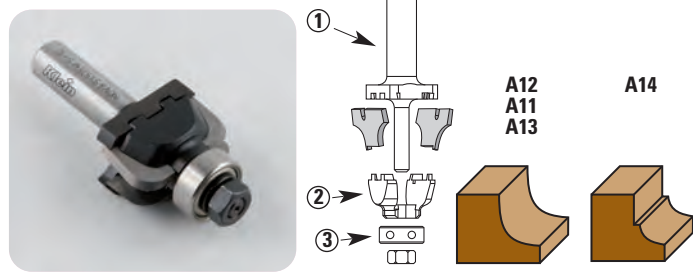

- Replaceable carbide tips
- Patent pending # 129720
- These tools have been checked by the BIA



S Ø 8	S Ø 12	D	R	Spare inserts
W206.350.C	W206.350.E	35	6,4	W206.A11
W206.351.C	W206.351.E	35	8	W206.A12
W207.380.C	W207.380.E	38	9,5	W207.A13
W208.350.C	W208.350.E	35	4,8	W208.A14

SPARE PARTS

1) Arbor

W200.000.C W200.000.E

2) Safety shield

W201.001.N

3) Ball bearing

Z050.005.N - Ø19/Ø6,4 x 7,1 mm

HW INTERCHANGEABLE INSERT ROUTER BITS "NOVA SYSTEM" Z=2

ART. W202 - W203 - W204 - W205

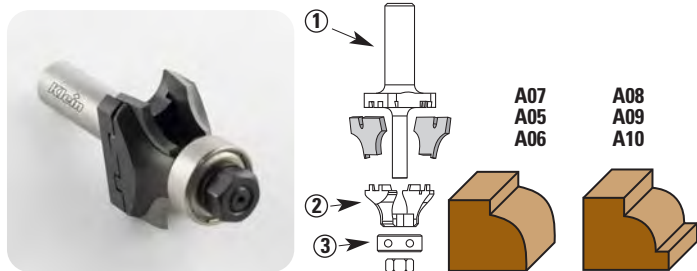

- Replaceable carbide tips
- Patent pending # 129720
- These tools have been checked by the BIA



S Ø 8	S Ø 12	D	R	Spare inserts
W202.350.C	W202.350.E	35	6,4	W202.A05
W202.351.C	W202.351.E	35	8	W202.A06
W203.380.C	W203.380.E	38	9,5	W203.A07
W204.350.C	W204.350.E	35	4,8	W204.A08
W204.351.C	W204.351.E	35	6,4	W204.A09
W205.380.C	W205.380.E	38	8	W205.A10

SPARE PARTS

1) Arbor

W200.000.C W200.000.E

2) Safety shield

W201.002.N

3) Ball bearing

Z050.005.N - Ø19/Ø6,4 x 7,1 mm

HW INTERCHANGEABLE INSERT ROUTER BITS "NOVA SYSTEM" Z=2

ART. W209 - W210

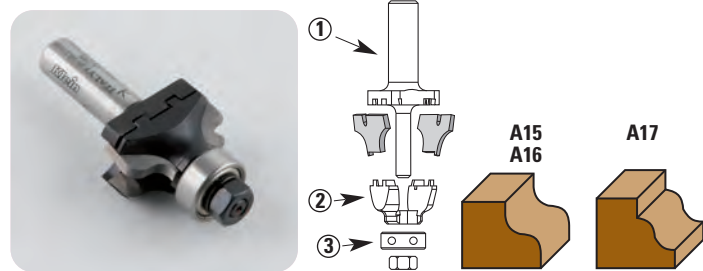

- Replaceable carbide tips
- Patent pending # 129720
- These tools have been checked by the BIA



S Ø 8	S Ø 12	D	R	R1	Spare inserts
W209.360.C	W209.360.E	36	4,0	4,5	W209.A15
W209.380.C	W209.380.E	38	4,0	4,5	W209.A16
W210.350.C	W210.350.E	35	4,0/4,0		W210.A17

SPARE PARTS

1) Arbor

W200.000.C W200.000.E W201.001.N

3) Ball bearing

Z050.005.N - Ø19/Ø6,4 x 7,1 mm

HW INTERCHANGEABLE INSERT ROUTER BITS "NOVA SYSTEM" Z=2

ART. W211 - W212 - W213

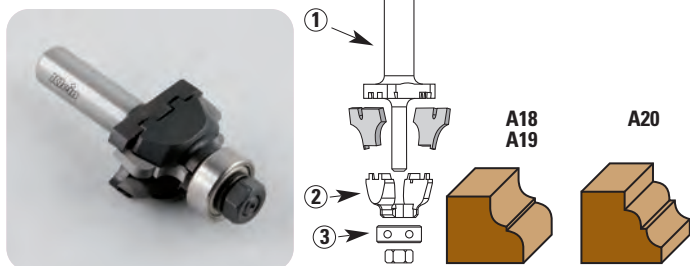

- Replaceable carbide tips
- Patent pending # 129720
- These tools have been checked by the BIA



S Ø 8	S Ø 12	D	R	Spare inserts
W211.350.C	W211.350.E	35	4,0/4,0	W211.A18
W212.380.C	W212.380.E	38	4,0/4,0	W212.A19
W213.380.C	W213.380.E	38	4,0/4,0	W213.A20

SPARE PARTS

1) Arbor

W200.000.C W200.000.E

2) Safety shield

W201.001.N

3) Ball bearing

Z050.005.N - Ø19/Ø6,4 x 7,1 mm

HW INTERCHANGEABLE INSERT ROUTER BITS "NOVA SYSTEM" Z=2

ART. W214 - W215 - W216

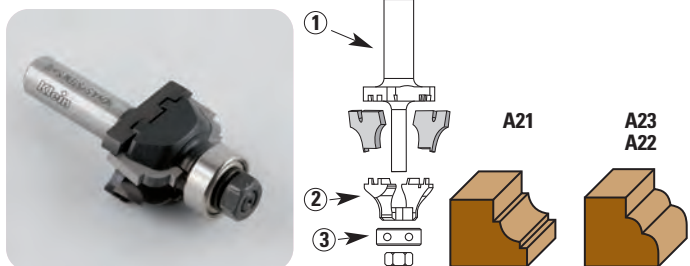

- Replaceable carbide tips
- Patent pending # 129720
- These tools have been checked by the BIA



S Ø 8	S Ø 12	D	R	Spare inserts
W214.350.C	W214.350.E	35	4,8	W214.A21
W215.350.C	W215.350.E	35	4,0/4,0	W215.A22
W216.380.C	W216.380.E	38	4,0/4,0	W216.A23

SPARE PARTS

1) Arbor

W200.000.C W200.000.E

2) Safety shield

W201.001.N

3) Ball bearing

Z050.005.N - Ø19/Ø6,4 x 7,1 mm

HW INTERCHANGEABLE INSERT ROUTER BITS "NOVA SYSTEM" Z=2

ART. W250 - W251

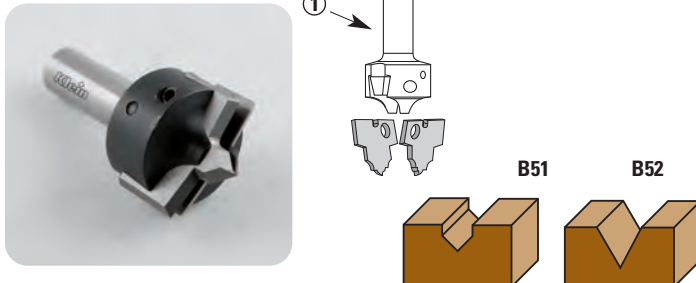

- Replaceable carbide tips
- Patent pending # 129720
- These tools have been checked by the BIA



S Ø 8	S Ø 12	D	α	Spare inserts
W250.095.C	W250.095.E	9,5	45°	W250.B51
W251.127.C	W251.127.E	12,7	30°	W251.B52

SPARE PARTS

1) Safety shield

W250.000.C W250.000.E

HW INTERCHANGEABLE INSERT ROUTER BITS "NOVA SYSTEM" Z=2

ART. W252 - W253

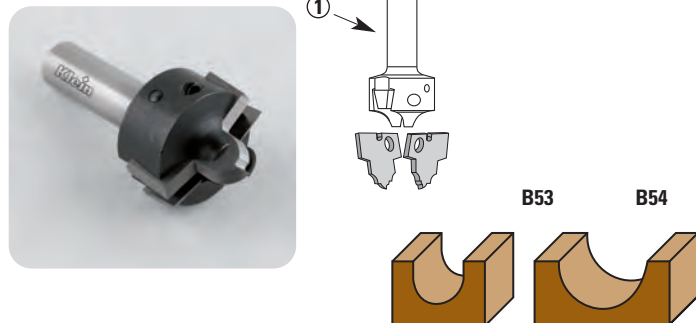

- Replaceable carbide tips
- Patent pending # 129720
- These tools have been checked by the BIA



S Ø 8	S Ø 12	D	R	Spare inserts
W252.127.C	W252.127.E	12,7	6,4	W252.B53
W253.254.C	W253.254.E	25,4	12,7	W253.B54

SPARE PARTS

1) Safety shield

W250.000.C W250.000.E

HW INTERCHANGEABLE INSERT ROUTER BITS "NOVA SYSTEM" Z=2

ART. W254

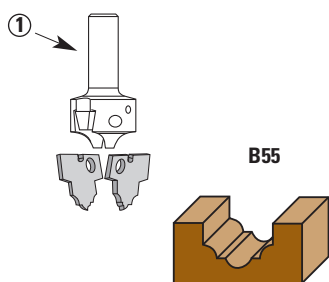

- Replaceable carbide tips
- Patent pending # 129720
- These tools have been checked by the BIA



S Ø 8	S Ø 12	D	R	Spare inserts
W254.190.C	W254.190.E	19	4,0/4,0	W254.B55

SPARE PARTS

1) Safety shield

W250.000.C	W250.000.E
------------	------------

HW INTERCHANGEABLE INSERT ROUTER BITS "NOVA SYSTEM" Z=2

ART. W254

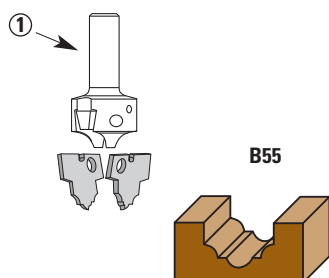

- Replaceable carbide tips
- Patent pending # 129720
- These tools have been checked by the BIA



S Ø 8	S Ø 12	D	R	Spare inserts
W254.190.C	W254.190.E	19	4,0/4,0	W254.B55

SPARE PARTS

1) Safety shield

W250.000.C	W250.000.E
------------	------------

DP DIAMOND ROUTER BITS (PCD)

DP ROUTER BITS

ART. X500 - X501 - X502 - X503

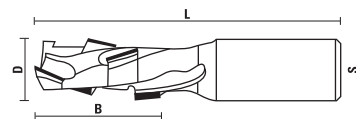

UP TO
30/50X
TOOL LIFE



- PCD tip height = 3 mm (up to three-times regrindable)
- HW plunging tip
- 1+1 flutes with axial angle for best performance
- PCD (Polycrystalline Diamond) tips
- Recommended for grooving, nesting and routing solid hard wood, veneered and laminated MDF, chipboard, hpl, trespa, plastic...
- Used on CNC router machines



RH rotation	LH rotation	D	B	L	S	Z	Tips
X500.120.R		12	27	87	12x35	1+1	3+1
X500.121.R		12	36	95	12x35	1+1	4+1
X501.160.R		16	27	87	16x45	1+1	3+1
X501.161.R	X501.161.L	16	36	95	16x45	1+1	4+1
X501.180.R		18	27	87	16x45	1+1	3+1
X501.181.R	X501.181.L	18	36	95	16x45	1+1	4+1
X501.182.R		18	44	105	16x45	1+1	5+1
X502.160.R		16	25	85	20x45	1+1	3+1
X502.180.R	X502.180.L	18	27	87	20x50	1+1	3+1
X502.181.R	X502.181.L	18	36	95	20x50	1+1	4+1
X502.182.R	X502.182.L	18	44	105	20x50	1+1	5+1
X502.183.R		18	53	113	20x50	1+1	6+1
X502.200.R	X502.200.L	20	27	87	20x50	1+1	3+1
X502.201.R	X502.201.L	20	36	95	20x50	1+1	4+1
X502.202.R	X502.202.L	20	44	105	20x50	1+1	5+1
X502.203.R	X502.203.L	20	53	113	20x50	1+1	6+1
X502.204.R		20	61	121	20x50	1+1	7+1
X502.205.R		20	70	130	20x50	1+1	8+1
X503.160.R		16	27	87	25x55	1+1	3+1
X503.180.R		18	27	87	25x55	1+1	3+1
X503.181.R	X503.181.L	18	36	95	25x55	1+1	4+1
X503.182.R	X503.182.L	18	44	105	25x55	1+1	5+1
X503.203.R	X503.203.L	20	53	113	25x55	1+1	6+1
X503.250.R		25	27	87	25x50	1+1	3+1
X503.251.R		25	36	95	25x50	1+1	4+1
X503.252.R		25	44	105	25x50	1+1	5+1
X503.253.R		25	53	113	25x50	1+1	6+1
X503.254.R		25	61	121	25x50	1+1	7+1
X503.255.R		25	70	130	25x50	1+1	8+1

DP ROUTER BITS

ART. X505 - X506

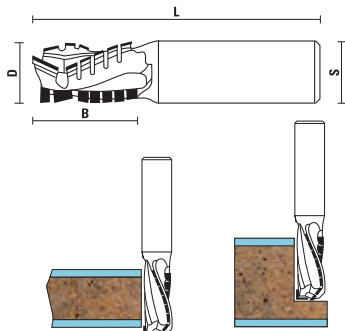

- **DP plunging tip**
- Recommended for grooving and routing veneered and double-sided laminated boards, also MDF
- Excellent finish on both sides of the workpiece thanks to the alternate shear angle
- **Higher feed rate** (max. 20.000 m/min)
- Used on CNC router machines
- Tooth height **H= 4 mm**



UP TO
30/50X
TOOL LIFE

Item	D	B	L	S	Z	Tips
X505.200.R	20	30	90	20x50	3+3	11
X505.201.R	20	35	95	20x50	3+3	13
X505.202.R	20	42	100	20x50	3+3	16
X505.203.R	20	45	105	20x50	3+3	17
X505.250.R	25	30	88	20x50	3+3	11
X505.251.R	25	35	95	20x50	3+3	13
X505.252.R	25	45	102	20x50	3+3	17
X505.253.R	25	50	110	20x50	3+3	19
X506.200.R	20	30	90	25x50	3+3	11
X506.201.R	20	35	95	25x50	3+3	13
X506.202.R	20	42	100	25x50	3+3	16
X506.250.R	25	30	88	25x50	3+3	11
X506.251.R	25	35	95	25x50	3+3	13
X506.252.R	25	42	102	25x50	3+3	17
X506.253.R	25	50	110	25x50	3+3	19

DP ROUTER BITS

ART. X508 - X509

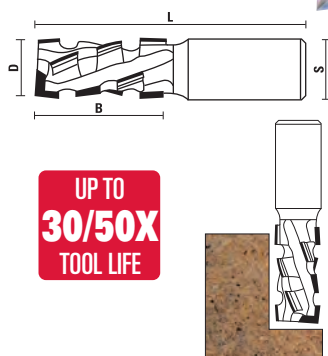

- **HW plunging tip**
- Used on CNC router machines
- Recommended for grooving and routing solid hard wood, veneered and laminated MDF
- Double number of DP tips compared with items X501÷X503
- Tooth height **H= 3 mm**



UP TO
30/50X
TOOL LIFE

RH rotation	LH rotation	D	B	L	S	Z	Tips
X508.160.R		16	27	85	16x45	2+2	6+1
X508.161.R	X508.161.L	16	36	94	16x45	2+2	8+1
X508.180.R		18	27	85	16x45	2+2	6+1
X508.181.R	X508.181.L	18	34	94	16x45	2+2	8+1
X508.182.R		18	43	103	16x45	2+2	10+1
X509.180.R	X509.180.L	18	27	85	20x50	2+2	6+1
X509.181.R	X509.181.L	18	36	95	20x50	2+2	8+1
X509.182.R	X509.182.L	18	44	103	20x50	2+2	10+1
X509.200.R	X509.200.L	20	27	85	20x50	2+2	6+1
X509.201.R	X509.201.L	20	36	94	20x50	2+2	8+1
X509.202.R	X509.202.L	20	44	103	20x50	2+2	10+1
X509.203.R	X509.203.L	20	53	112	20x50	2+2	12+1

DP ROUTER BITS Z=1

ART. X510



UP TO
30/50X
TOOL LIFE



- Special negative shear angle for best performance
- Right hand rotation
- Solid carbide tool body
- **2/3 times regrindable**
- For cutting and boring on panels of composite materials with lacquered or veneered surfaces
- Best results when working on **phenolic resins and HPL** (Fòrmica plastic)



Item	D	B	L	S
X510.040.R	4	10	60	12x35
X510.050.R	5	10	60	12x35
X510.060.R	6	10	60	12x35
X510.080.R	8	15	65	12x35
X510.100.R	10	15	65	12x35
X510.120.R	12	20	70	12x35

DP ROUTER BITS Z=2

ART. X512



UP TO
30/50X
TOOL LIFE

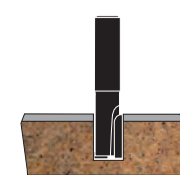

- Right hand rotation
- Solid carbide tool body (only Ø8 - Ø10 - Ø12)
- **2/3 times regrindable**
- For cutting and boring on panels of composite materials with lacquered or veneered surfaces
- Best results when working on **phenolic resins and HPL** (Fòrmica plastic)



Item	D	B	L	S
X512.080.R	8	15	65	12x35
X512.100.R	10	15	65	12x35
X512.120.R	12	25	65	12x35
X512.160.R	16	35	75	16x40

DP ROUTER BITS H=1,5

ART. X523

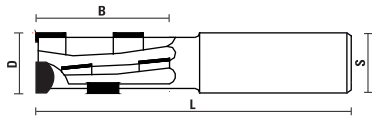

UP TO
30/50X
TOOL LIFE



- DP tip height 1,5 mm
- Recommended for grooving and routing solid hardwood, veneered and laminated MDF
- HW plunging tip
- To be used on CNC router machines



RH rotation	D	B	L	S	Z	Tips
X523.253.R Selling out	25	62	127	25x55	3+3	7+1

DP ROUTER BITS FOR NESTING OPERATION

ART. X528

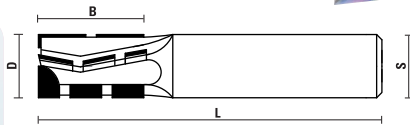

UP TO
30/50X
TOOL LIFE

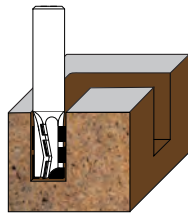

- PCD tips height = 3 mm (three-times regrindable)
- Sturdy tool body in high density metal (Densimet®) for highest performance and longer tool life
- Recommended tool for Nesting operations on chipboard, veneered, plywood, laminated, melamine and MDF
- Compression Z=3+3 router bits for excellent results on both top and bottom side of the panel and special shear angle geometry
- To be used on CNC router machines
- PCD plunging tip
- Recommended for using together with our art. T139 "TORNADO Chip and Dust conveyor clamping nut"



Item	D	B	L	S	Z	Tips
X528.120.R	12	20	70	12x45	3+3	8
X528.121.R	12	25	75	12x45	3+3	10
X528.122.R	12	30	80	12x45	3+3	12
X528.123.R	12	35	85	12x45	3+3	14
X528.140.R	14	20	70	16x45	3+3	8
X528.141.R	14	25	75	16x45	3+3	10
X528.142.R	14	30	80	16x45	3+3	12
X528.160.R	16	20	70	16x45	3+3	8
X528.161.R	16	25	75	16x45	3+3	10
X528.162.R	16	30	80	16x45	3+3	12

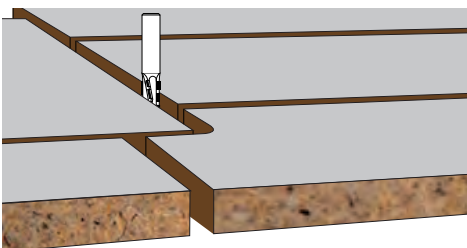

DP DOWEL DRILLS

ART. X530 - X531

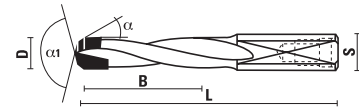

UP TO
30/50X
TOOL LIFE

- Shank with flat and screw
- Suitable for drilling very abrasive materials
- Used on CNC router machines



RH rotation	LH rotation	D	B	L	S	Z
X530.050.R	X530.050.L	5	27	57,5	10x26	2
X530.060.R	X530.060.L	6	27	57,5	10x26	2
X530.080.R	X530.080.L	8	27	57,5	10x26	2
X531.050.R	X531.050.L	5	35	70	10x30	2
X531.080.R	X531.080.L	8	35	70	10x30	2

DP THROUGH-HOLE DRILL BITS

ART. X532 - X533

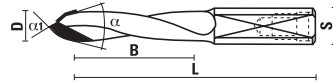

UP TO
30/50X
TOOL LIFE

- Shank with flat and screw
- Suitable for drilling very abrasive materials
- Used on CNC router machines



RH rotation	LH rotation	D	B	L	S	Z
X532.050.R	X532.050.L	5	27	57,5	10x26	1
X533.050.R	X533.050.L	5	35	70	10x26	1
X533.060.R	X533.060.L	6	35	70	10x26	2
X533.080.R	X533.080.L	8	35	70	10x26	2

DP HINGE BORING BITS

ART. X540 - X541

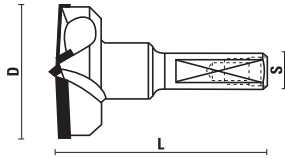

UP TO **30/50X** TOOL LIFE



- Shank with flat and screw
- **HW centerpoint**
- Suitable for drilling very abrasive materials
- Used on CNC router machines

RH rotation	LH rotation	D	L	S	Z
X540.150.R	X540.150.L	15	56	10x26	2+2
X540.160.R	X540.160.L	16	56	10x26	2+2
X540.180.R	X540.180.L	18	56	10x26	2+2
X540.200.R	X540.200.L	20	56	10x26	2+2
X540.250.R	X540.250.L	25	56	10x26	2+2
X540.260.R	X540.260.L	26	56	10x26	2+2
X540.300.R	X540.300.L	30	56	10x26	2+2
X540.350.R	X540.350.L	35	56	10x26	2+2
X540.400.R	X540.400.L	40	56	10x26	2+2
X541.150.R	X541.150.L	15	70	10x26	2+2
X541.200.R	X541.200.L	20	70	10x26	2+2
X541.250.R	X541.250.L	25	70	10x26	2+2
X541.350.R	X541.350.L	35	70	10x26	2+2

DP ROUTER BITS FOR "LAMELLO"®

ART. X569

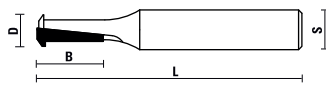

UP TO **30/50X** TOOL LIFE



- **DP insert knives (polycrystalline diamond) last almost forever (up to 30/50 times longer than standard carbide bits) save time and money**
- Suitable for making the groove for Lamello P-System with CNC router
- RH rotation

RH rotation	D	B	L	S	Z
X569.098.R	9,8	20	80	12	1



DP TRIMMING BITS WITH BALL BEARING Z=2

ART. XA119 - XB119 - XC119

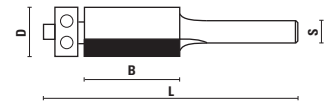

UP TO **30/50X** TOOL LIFE

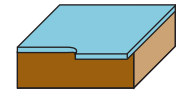

- Rh rotation
- **DP tips (polycrystalline diamond) last almost forever (up to 30/50 times longer than standard carbide bits) save time and money**
- Excellent for trimming: aluminium, composites, fiberglass, hard and soft wood, MDF and plastic



S Ø 6	S Ø 1/4" (6,35)	S Ø 8	D	B	L
XA119.127.R	XB119.127.R	XC119.127.R	12,7	11	60



Z050.003.N



Z053.002.N



Z054.002.N



Z051.002.R

DP ROUND OVER BITS WITH BALL BEARING Z=2

ART. XC123

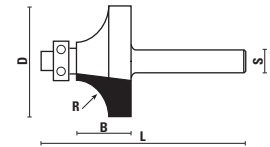

UP TO **30/50X** TOOL LIFE

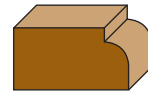

- Rh rotation
- **DP tips (polycrystalline diamond) last almost forever (up to 30/50 times longer than standard carbide bits) save time and money**
- Delrin® ball bearing to avoid marking and scratches
- Excellent for corner: aluminium, composites, fiberglass, hard and soft wood, MDF and plastic



S Ø 8	D	R	B	L
XC123.167.R	16,7	2	8	50
XC123.187.R	18,7	3	9,5	50



Z050.100.N



Z053.003.N



Z054.002.N



Z051.002.R

DP GROOVE CUTTER FOR "LAMELLO"® JOINTS CLAMEX P

ART. XAH

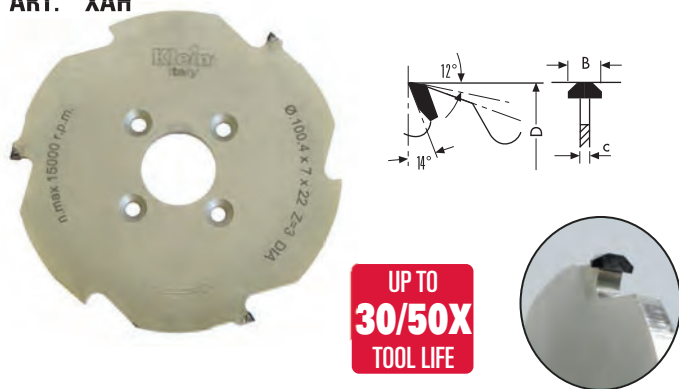

- Suitable for making Clamex P connecting fittings for furniture, shelf units and kitchen making
- To be used both on CNC machines and ZETA P2 hand power tool
- Recommended for grooving corner and longitudinal joints on hardwood, veneered and laminated MDF with the P-System anchorage

Item	D	d	B	Z	Pin holes
XAH100.10330	100,4	30	7	3	4/6,6/48
XAH100.10630	100,4	30	7	6	4/6,6/48
XAH100.10322	100,4	22	7	3	4/4/36

CLAMEX P JOINTS

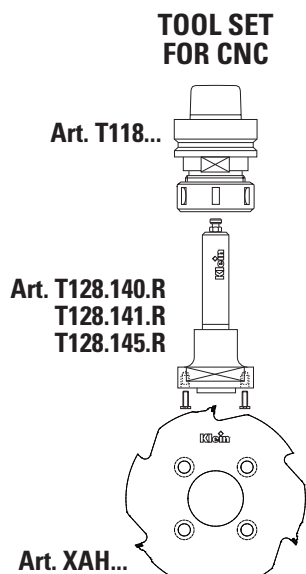

P-SYSTEM ANCHORAGE

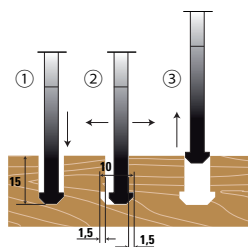

DP GROOVE CUTTER FOR "LAMELLO"® JOINTS ART. XAH



- For Lamello Clamex S classic biscuit joints
- To be used on Top 20, Top 21, Classic X

Item	D	d	B	Z	Pin holes
XAH100.20622	100	22	3,96/2,8	3	4/4/36

DP SAW BLADES FOR CUTTING ABRASIVE MATERIALS

ART. XGE

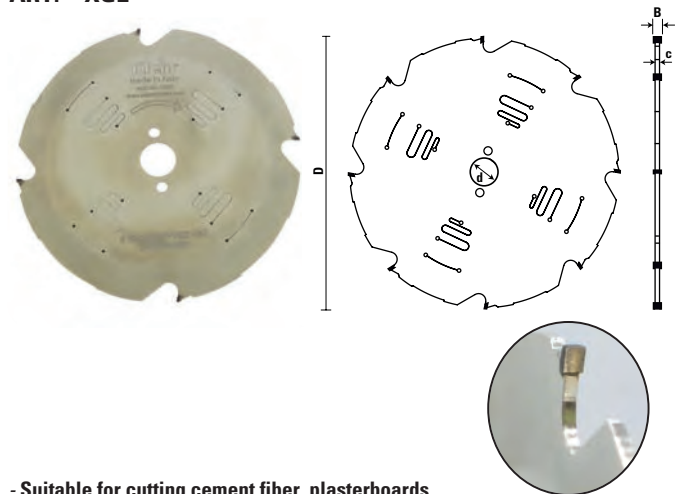

- Suitable for cutting cement fiber, plasterboards, fiber reinforced plastics, solid surface and Eternit
- DP flat teeth
- DP tooth height 3,5 mm
- ♪ = no-noise

Pin holes: PH02= 2/7/42 + 2/9,5/46,5 + 2/10/60

Item	D	d	B/c	Z	Pin holes
XGE160.10420 ♪	160	20	2,4/1,6	4	2/6/32
XGE160.10820 ♪	160	20	2,4/1,6	8	2/6/32
XGE190.10420 ♪	190	20	2,4/1,6	4	2/6/32
XGE200.10430 ♪	200	30	2,4/1,6	4	2/7/42
XGE200.10830 ♪	200	30	2,4/1,6	8	2/7/42
XGE216.10830 ♪	216	30	2,4/1,6	8	-
XGE230.10630 ♪	230	30	2,4/1,6	6	2/7/42
XGE250.10630 ♪	250	30	2,4/1,6	6	PH02
XGE250.11230 ♪	250	30	2,4/1,6	12	PH02
XGE300.11230 ♪	300	30	2,4/1,6	12	PH02
XGE300.12030 ♪	300	30	2,4/1,6	20	PH02

DP SAWBLADES FOR LAMINATES

ART. XFC

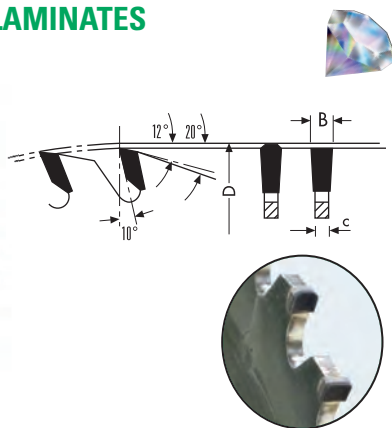

- (FZ/TR) DP triple chip teeth
- For cutting along and across grain of **softwoods, hardwood and exotic timber, double-side veneer laminate boards, MDF and plywood**
- Tooth height **H= 4 mm**

Pin holes: **PH02= 2/7/42 + 2/9,5/46,5 + 2/10/60**

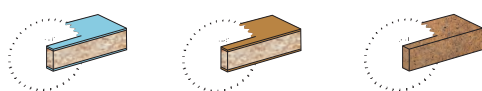

UP TO
30/50X
TOOL LIFE

Item	D	d	B/c	H	Z	Pin holes
XFC250.04830	250	30	3,2/2,2	4	48	PH02
XFC250.06030	250	30	3,2/2,2	4	60	PH02
XFC300.06030	300	30	3,2/2,2	4	60	PH02
XFC300.07230	300	30	3,2/2,2	4	72	PH02
XFC350.07230	350	30	3,5/2,5	4	72	PH02
XFC350.08430	350	30	3,5/2,5	4	84	PH02
XFC350.09630	350	30	3,5/2,5	4	96	PH02

DP CONICAL SCORING SAWBLADES

ART. XFI

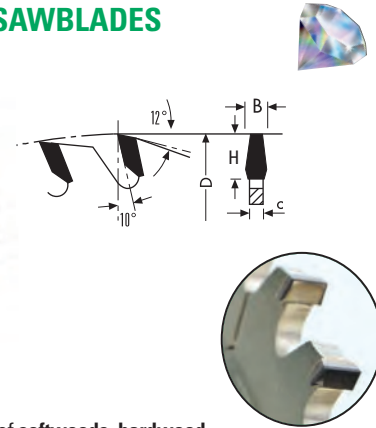

- (KON/FZ) DP conical teeth
- For cutting along and across grain of **softwoods, hardwood and exotic timber, double-side veneer laminate boards, MDF and plywood**
- Tooth height **H= 4 mm**

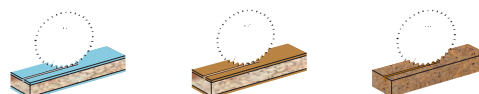

UP TO
30/50X
TOOL LIFE

Item	D	d	B/c	Z	Pin holes
XFI120.02020	120	20	3,1-3,7/2,2	20	
XFI120.02022	120	22	3,1-3,7/2,2	20	
XFI125.02420	125	20	3,1-3,7/2,2	20	
XFI125.02422	125	22	3,1-3,7/2,2	20	
XFI160.03645	160	45	4,4-5,0/3,2	36	Giben
XFI160.03655	160	55	4,4-5,0/3,2	36	Gabbiani
XFI180.03620	180	20	4,4-5,0/3,2	36	
XFI180.03645	180	45	4,4-5,0/3,2	36	Holzma
XFI180.04450	180	50	4,4-5,0/3,2	44	Giben
XFI181.03645	180	45	4,8-5,6/3,5	36	Holzma
XFI182.03620	180	20	5,8-6,6/4,0	36	Anthon
XFI200.03620	200	20	4,4-5,0/3,2	36	
XFI200.03630	200	30	4,4-5,0/3,2	36	
XFI200.03645	200	45	4,4-5,0/3,2	36	Holzma
XFI200.03665	200	65	4,4-5,0/3,2	36	Selco
XFI201.03645	200	45	4,8-5,6/3,5	36	Holzma
XFI201.03665	200	65	4,8-5,6/3,5	36	Selco
XFI202.03620	200	20	5,0-5,8/3,5	36	Schelling
XFI203.03645	200	45	5,8-6,6/4,0	36	Holzma
XFI215.04250	215	50	4,4-5,0/3,2	42	Giben

DP ADJUSTABLE SCORING SAWBLADES

ART. XFL

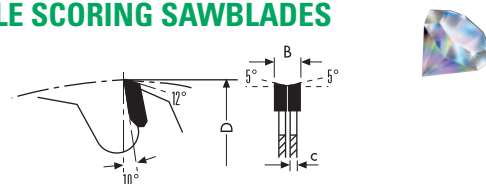

- (LFZ) DP flat teeth
- Supplied with spacers
- For cutting along and across grain of **softwoods, hardwood and exotic timber, double-side veneer laminate boards, MDF and plywood**
- For panel sizing machines
- Tooth height **H= 4 mm**

Item	D	d	B/c	Z
XFL125.01020	125	20	2,8-3,4/2,2	10+10
XFL125.01022	125	22	2,8-3,4/2,2	10+10

DP PANEL SIZING SAWBLADES

ART. XHC

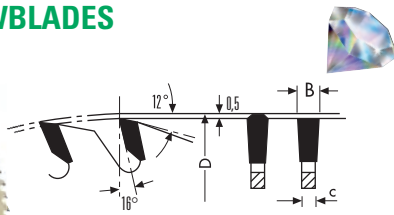

UP TO
30/50X
TOOL LIFE



- (FZ/TR) DP triple chip teeth
- For cutting along and across grain of **softwoods, hardwood and exotic timber, double-side veneer laminate boards, MDF and plywood**
- Tooth height **H= 4 mm** (can be produced also with H= 5/6 mm)

Pin holes:

PH01= 2/7/42 + 2/9,5/46,5 + 2/10/60

PH04= 2/14/110 + 2/7/110 + 4/9/100 + 4/19/120 + 2/9/130 (Selco-Gabbani-SCM)

PH05= 4/15/105 + 3/7/100 (Giben-Homag-MacMazza)

Item	D	d	B/c	Z	Pin holes
XHC300.06030	300	30	4,4/3,2	60	PH01
XHC300.06065	300	65	4,4/3,2	60	Selco
XHC320.06050	320	50	4,4/3,2	60	Giben
XHC320.06065	320	65	4,4/3,2	60	Selco
XHC330.06050	330	50	4,4/3,2	60	Giben
XHC350.07230	350	30	4,4/3,2	72	PH01
XHC350.07250	350	50	4,4/3,2	72	Giben
XHC350.07260	350	60	4,4/3,2	72	Holzma
XHC350.07265	350	65	4,4/3,2	72	Selco
XHC350.07275	350	75	4,4/3,2	72	PH05
XHC350.07280	350	80	4,4/3,2	72	PH04
XHC360.07250	360	50	4,4/3,2	72	Giben
XHC360.07265	360	65	4,4/3,2	72	Selco
XHC370.07230	370	30	4,4/3,2	72	PH01
XHC380.07260	380	60	4,8/3,5	72	Holzma
XHC400.07230	400	30	4,4/3,2	72	2/10/60
XHC400.07260	400	60	4,4/3,2	72	Anthon
XHC400.07275	400	75	4,4/3,2	72	Giben-Homag
XHC400.07280	400	80	4,4/3,2	72	PH04
XHC401.07260	400	60	4,8/3,5	72	Holzma
XHC420.07260	420	60	4,8/3,5	72	Holzma
XHC430.07275	430	75	4,8/3,5	72	Giben
XHC430.07280	430	80	4,8/3,5	72	PH04
XHC450.07230	450	30	4,8/3,5	72	Schelling
XHC450.07280	450	80	4,8/3,5	72	PH04
XHC451.07260	450	60	4,8/3,5	72	Holzma
XHC451.07280	450	80	4,8/3,5	72	PH04
XHC460.07230	460	30	4,4/3,2	72	Schelling
XHC470.07275	470	75	4,4/3,2	72	Giben
XHC480.07230	480	30	4,4/3,2	72	Schelling
XHC481.07260	480	60	4,8/3,5	72	Holzma
XHC481.07280	480	80	4,8/3,5	72	Selco
XHC500.07260	500	60	4,8/3,5	72	Holzma
XHC520.07260	520	60	4,8/3,5	60	Holzma

DP STANDARD REVERSIBLE KNIVES

ART. XZ055

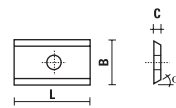

SOLD INDIVIDUALLY

UP TO
30/50X
TOOL LIFE

- These knives replace perfectly the HW standard knives
- **2 cutting edges**
- Lifetime up to 35/50 times longer compared to the HC05 (HW) knives
- 1 fixing hole
- Regrindable knives
- **CAUTION:** when sharpening a multicutter bit make sure that all the knives are mounted at the same height

Item	L	B	C	α
XZ055.000.N	7,5	12	1,5	35°
XZ055.012.N	9,6	12	1,5	35°
XZ055.002.N	15	12	1,5	35°
XZ055.003.N	20	12	1,5	35°
XZ055.014.N	25	12	1,5	35°

DP STANDARD REVERSIBLE KNIVES

ART. XZ055

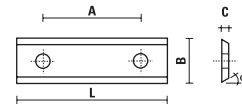

SOLD INDIVIDUALLY

UP TO
30/50X
TOOL LIFE

- These knives replace perfectly the HW standard knives
- **2 cutting edges**
- Lifetime up to 35/50 times longer compared to the HC05 (HW) knives
- 2 fixing hole
- Regrindable knives
- **CAUTION:** when sharpening a multicutter bit make sure that all the knives are mounted at the same height

Item	L	B	C	α	A
XZ055.008.N	30	12	1,5	35°	14
XZ055.009.N	40	12	1,5	35°	26
XZ055.010.N	50	12	1,5	35°	26
XZ055.011.N	60	12	1,5	35°	26

DP STANDARD REVERSIBLE KNIVES

ART. XZ055

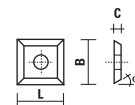
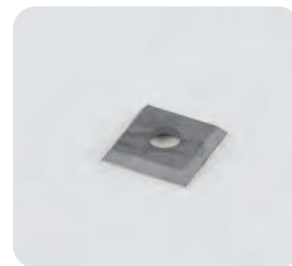

SOLD INDIVIDUALLY

UP TO
30/50X
TOOL LIFE

- **4 cutting edges**
- Lifetime up to 35/50 times longer compared to the HC05 (HW) knives
- 1 fixing hole
- Regrindable knives
- **CAUTION:** when sharpening a multicutter bit make sure that all the knives are mounted at the same height

Item	L	B	C	α
XZ055.001.N	12	12	1,5	35°

SPARE PARTS

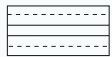

BUSHINGS
Page 10.03

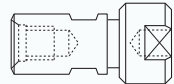

**COLLET CHUCKS WITH
SPRING COLLETS 6 - 8 - 9,5**
Page 10.03



SETTING RINGS
Page 10.03



ADJUSTABLE DEPTH STOPPER
Page 10.03

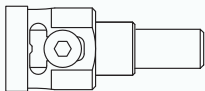

ADJUSTABLE DEPTH STOPPER
Page 10.03

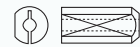

DRILL HOLDER-SLEEVE
Page 10.03

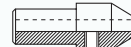

DRILL HOLDERS
Page 10.04



EXTENSION SHAFTS
Page 10.04



EXTENSION SHAFTS
Page 10.04



**SHAFT ADAPTERS Ø10 FOR
BORING MACHINES**
Page 10.04

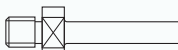

**SHAFT ADAPTERS
FOR PORTABLE ROUTERS**
Page 10.04

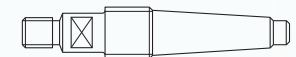

SHAFT ADAPTERS MK2
Page 10.05

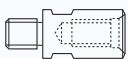

ADAPTERS OR EXTENSION SHAFTS
Page 10.05



BALL BEARINGS
Page 10.05



"DELRIN®" BALL BEARINGS
Page 10.05



CHEESE HEAD SCREWS
Page 10.06



COUNTERSUNK HEAD SCREWS
Page 10.06



DUST PLUG
Page 10.06



SET SCREWS
Page 10.06



ROUNDED HEAD SCREWS
Page 10.06



SLOTTED CHEESE HEAD SCREWS
Page 10.06



**HEXAGON SOCKET SET SCREWS
FOR WEDGES**
Page 10.07



ALLEN KEYS
Page 10.07



TORX KEYS
Page 10.07

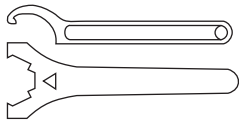

WRENCHES
Page 10.07

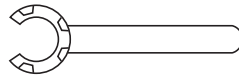

WRENCHES FOR COLLET NUT "MINI"
Page 10.07

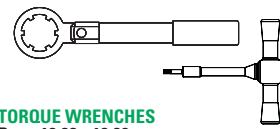

TORQUE WRENCHES
Page 10.08 - 10.09



WASHERS
Page 10.10



SPRING WASHERS
Page 10.10

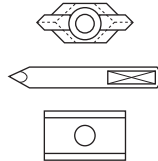

KNIVES
Page 10.10

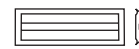

HW "VERSOFIX" KNIVES
Page 10.10

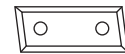

HW STANDARD REVERSIBLE KNIVES
Page 10.10



HW KNIVES
Page 10.11



WEDGES
Page 10.12



SPACERS
Page 10.12



LOCK RING
Page 10.12



O-RING
Page 10.12

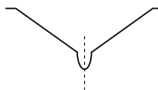

SPRINGS
Page 10.12



THREADED RINGS
Page 10.12

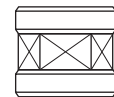

THREADED NUTS FOR MK2 SHANKS
Page 10.13

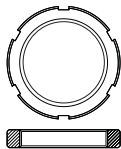

COLLET NUTS
Page 10.13



"NO-NOISE" COLLET NUTS
Page 10.13

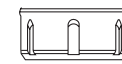

COLLET NUTS
Page 10.13

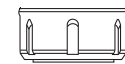

COLLET NUTS WITH BALL BEARINGS
Page 10.13

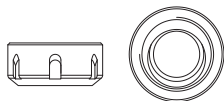

CLAMPING NUT WITH ECCENTRIC RING
Page 10.14

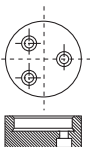

END CAPS
Page 10.14

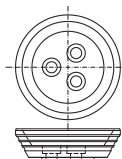

LIFTING FLANGE FOR CUTTER ARBORS
Page 10.14

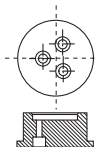

FIXING FLANGE FOR ART. T132.350.NS
Page 10.14



REDUCTION RINGS FOR SAWBLADES
Page 10.15



REDUCTION RINGS FOR CUTTERHEADS
Page 10.15



REDUCING BUSHES
Page 10.15

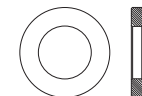

SPACERS AND SPACERS SET
Page 10.16

BUSHINGS

ART. Z001

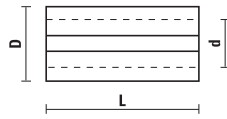

Item	D	d	L
Z001.001.N	8	6	25
Z001.002.N	9,5	6	25
Z001.003.N	9,5	8	25
Z001.004.N	10	8	25
Z001.005.N	12	8	25
Z001.006.N	12	6	25
Z001.007.N	12	10	25
Z001.008.N	16	13	40
Z001.009.N	8	6,4	25
Z001.010.N	12	9,5	25
Z001.011.N	10	6	25
Z001.012.N	8	5	25
Z001.013.N	8	4	25
Z001.014.N	8	3	25
Z001.015.N	10	5	25
Z001.016.N	10	4	25
Z001.017.N	9,5	6,4	25
Z001.018.N	12,7	9,5	25
Z001.019.N	12,7	8	25
Z001.020.N	12,7	6,4	25

COLLET CHUCKS WITH SPRING COLLETS 6 - 8 - 9,5

ART. Z002

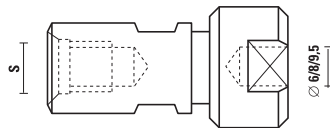

Supplied with nr 3 spring collets Ø6 - Ø8 - Ø9,5

Item	S
Z002.001.R	M12x1 (kit with spring collet)
Z002.002.R	M10x1,5 (kit with spring collet)

Spare parts

Z002.101.R chuck without collets	M12x1
Z002.102.R chuck without collets	M10x1,5
Z002.160.R	spring collet Ø6
Z002.180.R	spring collet Ø8
Z002.195.R	spring collet Ø9,5

SETTING RINGS

ART. Z003

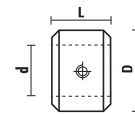
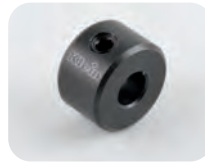

- Rings for setting the drilling depth use when working with manual feed
- Used with Art. R101 - R201 - R 205

Item	d	D	L
Z003.050.N	5	16	10
Z003.060.N	6	16	10
Z003.070.N	7	18	10
Z003.080.N	8	18	10
Z003.090.N	9	20	10
Z003.100.N	10	20	10
Z003.120.N	12	22	10



Z051.301.R



Z052.006.N

ADJUSTABLE DEPTH STOPPER

ART. Z003



1



2

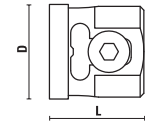
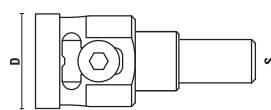

- Z003.900.N for diam. from 2.4÷4, depth stopper made in metal alloy with **ball bearing inside for no-friction operations**
- Z003.906.N for diam. 5 and 6 with a **special collar made in Delrin for low friction operation and easy depth adjustment**
- Z003.905.N for diam. from 2.4÷4 with a **special collar made in Delrin for low friction operation and easy depth adjustment**

Item	D	Drawing
Z003.900.N	32	1
Z003.905.N	25	2
Z003.906.N	28	2

DRILL HOLDER-SLEEVE

ART. Z010

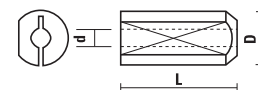

Used with Art. L120



Item	d	D	L
Z010.020.N	2	10	24
Z010.025.N	2,5	10	24
Z010.030.N	3	10	24
Z010.032.N	3,2	10	24
Z010.035.N	3,5	10	24
Z010.040.N	4	10	24
Z010.045.N	4,5	10	24
Z010.050.N	5	10	24
Z010.060.N	6	10	24

DRILL HOLDERS

ART. Z011

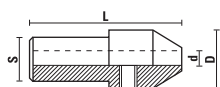

Used with Art. L120



Item	d	D	L	S
Z011.020.N	2	15	35	10x19
Z011.025.N	2,5	15	35	10x19
Z011.030.N	3	15	35	10x19
Z011.032.N	3,2	15	35	10x19
Z011.035.N	3,5	15	35	10x19
Z011.040.N	4	15	35	10x19
Z011.045.N	4,5	15	35	10x19
Z011.050.N	5	15	35	10x19
Z011.060.N	6	15	35	10x19



Z051.311.R



Z052.102.N

EXTENSION SHAFTS

ART. Z021

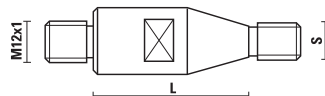
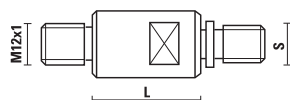

Used with Art. R130

RH rotation	LH rotation	S	L
Z021.025.R	Z021.025.L	M10/11	25
Z021.035.R	Z021.035.L	M10/11	35
Z021.045.R	Z021.045.L	M10/11	45
Z021.125.R	Z021.125.L	M10/30°	25
Z021.135.R	Z021.135.L	M10/30°	35
Z021.145.R	Z021.145.L	M10/30°	45

EXTENSION SHAFTS

ART. Z021

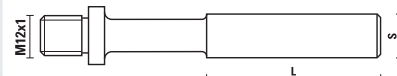

Used with Art. R130 and
Art. F101 - F103 - F104 - F105 - F202 - F203 - F204

RH rotation	LH rotation	S	L
Z021.213.R	Z021.213.L	13	50
Z021.216.R	Z021.216.L	16	50

SHAFT ADAPTERS Ø10 FOR BORING MACHINES

ART. Z021

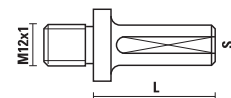

Used with Art. R130

RH rotation	LH rotation	S	L
Z021.310.R	Z021.310.L	10	27
Z021.311.R	Z021.311.L	10	40
Z021.312.R	Z021.312.L	10	47

SHAFT ADAPTERS FOR PORTABLE ROUTERS

ART. Z021

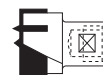
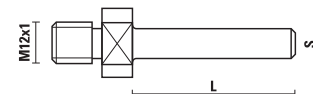

Used with Art. R130 and
Art. F101 - F103 - F104 - F105 - F202 - F203 - F204

RH rotation	S	L
Z021.406.R	6	40
Z021.408.R	8	40
Z021.409.R	9,5	40
Z021.410.R	10	40
Z021.412.R	12	40

SHAFT ADAPTERS MK2

ART. Z021

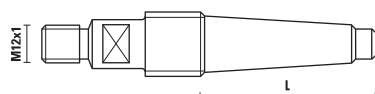

Used with Art. R130

RH rotation	S	L
Z021.500.R	MK2/M20	67

ADAPTERS OR EXTENSION SHAFTS

ART. Z021

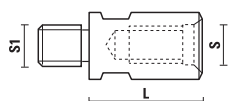

Used with Art. R130
and Art. F101 - F103 - F104 - F105 - F202 - F203 - F204

RH rotation	S	S1	L
Z021.600.R	M12x1	M12x1	25
Z021.601.R	M12x1	M10x1,5	25
Z021.610.R	M10x1,5	M12x1	25
Z021.611.R	M10x1,5	M10x1,5	25

VISIT OUR WEBSITE
www.sistemiklein.com



BALL BEARINGS

ART. Z050

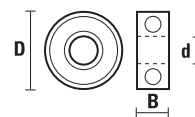

Item	D	d	B
Z050.037.N NEW	4,8	2,4	2,4
Z050.017.N	6,4	3,2	2,8
Z050.032.N NEW	8	5	2,5
Z050.001.N	9,5	3,2	4
Z050.002.N	9,5	4,8	3,2
Z050.031.N NEW	12	8	3,5
Z050.003.N	12,7	4,8	5
Z050.007.N	12,7	6,4	4,7
Z050.019.N	14	8	4
Z050.011.N	15,8	6,4	5
Z050.004.N	16	5	5
Z050.018.N	16	8	5
Z050.022.N	16	4,8	5
Z050.005.N	19	6,4	7,1
Z050.006.N	19	6	6
Z050.012.N	19	12,7	4
Z050.023.N	19	4,8	5
Z050.024.N	19	5	5
Z050.008.N	22	8	7
Z050.009.N	25,4	15	5,5
Z050.010.N	28	8	9
Z050.015.N	28,6	12,7	8
Z050.016.N	33,5	8	8,6
Z050.014.N	35	15	11
Z050.013.N	38	15	8,5

"DELFIN®" BALL BEARINGS

ART. Z050

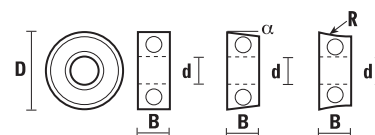

Used for working solid surface (**CORIAN®**)

Item	D	d	B	α	R
Z050.100.N	12,7	4,8	3,2	0°	
Z050.101.N	19	6,4	5	0°	
Z050.105.N	19	6,4	6,4		R=12,7
Z050.111.N	19	6	7	0°	
Z050.113.N	19,5	6,4	6,4		R=11,9
Z050.102.N	21,8	6,4	5	10°	
Z050.110.N	22	6	7	11°	
Z050.103.N	22,2	6,4	5	5°	
Z050.120.N	22,2	6,4	5	10°	
Z050.106.N	25,4	6,4	7	5°	
Z050.107.N	28	8	8,5	0°	
Z050.104.N	28,6	15	7	0°	
Z050.112.N	28,6	7,9	7	0°	
Z050.108.N	29	8	8,5	0°	
Z050.109.N	34	8	8,5	0°	

CHEESE HEAD SCREWS

ART. Z051

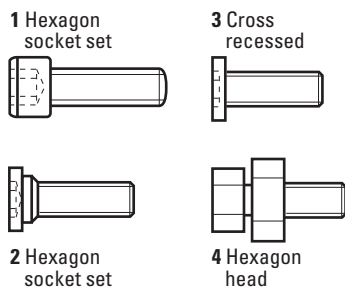

Item	Description	Draw.
Z051.001.R	M 2,5x12 ch 1,9	1
Z051.002.R	M 3,5x13 ch 2,4	1
Z051.004.R	M 5x17 ch 4	1
Z051.006.R	M 2,2x8 for art. A119.064.R	3
Z051.007.R	M 5x13 ch 3 for art. E316	2
Z051.008.R	M 3x12 ch 2,4	1
Z051.012.R	M 5x16 ch 4 for art. R110.600.R	1
Z051.013.R	M 6,3x19 ch 4,7 for art. R110.800.R	1
Z051.016.R	M 6x25 ch 5 for art. T128 cutter arbors	1
Z051.050.R	anti dust set for art. WE178	
Z051.312.R	M 5x10 for NOVASYSTEM	1
Z051.401.R	M 8x10	1
Z051.408.R	M 6x8 for art. W168	1
Z051.409.R	M 5x16 for art. W168	1
Z051.506.R	M 8x30 hex socket 13 complete with hexagon nut for art. T128.140.R	4

COUNTERSUNK HEAD SCREWS

ART. Z051

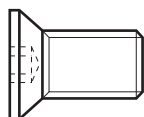

Item	Description
Z051.011.R	M 4x8 Torx T15
Z051.014.R	M 6x10 for art. T128.140.R slotted head
Z051.015.R	M 5x15 ch 3 for art. A/B/C/E/G - 117.280.R
Z051.017.R	M 4x8 ch 2 45" for art. W113/114
Z051.018.R	M 4x12 for art. T128.141.R
Z051.020.R	M 5x6,75 ch 3 for art. W190
Z051.024.R	M 6x15 for art. Z092
Z051.205.R	M 5x12,3 Torx T20 for art. W190
Z051.309.R	M 3x6 Torx T9
Z051.310.R	M 3x8 Torx T9
Z051.315.R	M 4x6,5 Torx T9
Z051.403.R	M 5x6 Torx T20
Z051.405.R	M 5x15 ch 2,5
Z051.700.R	M 4x3,2 Torx T15
Z051.701.R	M 5x7 Torx T15

DUST PLUG

ART. Z051

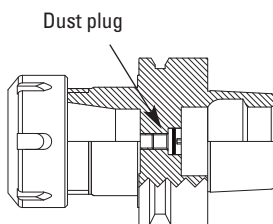
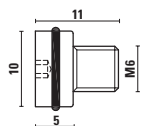

- To be used with our HSK toolholders to avoid any contamination of dust into the electrospindle.
- Inexpensive and easy to use.

Item	Description
Z051.070.N	M6x6

SET SCREWS

ART. Z051



Item	Description	Draw.
Z051.005.R	M 3x2,5 ch 1,6 with flat point	1
Z051.101.R	M 2,5x2,5 ch 1,3 with flat point	1
Z051.102.R	M 4x4 ch 2 with flat point	1
Z051.300.R	M 6x6 ch 3 with cone point for L130 D=Ø 8÷12	1
Z051.301.R	M 5x5 ch 2,5 with flat point	1
Z051.302.R	M 5x10	2
Z051.303.R	M 5x6 ch 2,5 with cone point for art. L130 D=Ø 4÷8 1	
Z051.304.R	M 6x6 ch 3 with flat point for art. L131 D=Ø 10÷12 1	
Z051.306.R	M 5x6 ch 2,5 with cone point	1
Z051.311.R	M 4x5 ch 2 with flat point for art. Z011	1
Z051.313.R	M 5x4 ch 2,5 with flat point	1
Z051.314.R	M 6x5 ch 3 with flat point for art. L131 D=Ø 10 1	
Z051.321.R	M 3x5 ch 1,6	1
Z051.324.R	M 5x3 ch 1,6 for art. R155÷R159	1
Z051.404.R	M 3x6 ch 1,5 with cone point for art. W182	1
Z051.407.R	M 6x10 ch 3	1
Z051.704.R	M 8x12 ch 4 with cyl point for art. SA	1
Z051.705.R	M 8x16 ch 4 with cyl point for art. SA	1

ROUNDED HEAD SCREWS

ART. Z051

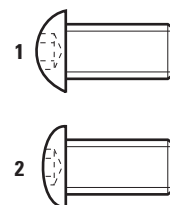

Item	Description	Draw.
Z051.010.R	M 4x8 - Ø 9 - T15	1
Z051.021.R	M 3,5x6 - Ø 7 - T15	1
Z051.201.R	M 4x9 - Ø 7,8 - T15	1
Z051.210.R	M 3,5x7 - Ø 7,8 - T15	2
Z051.211.R	M 3,5x7 - Ø 9 - T15	1
Z051.212.R	M 3,5x6,6 for art. W170 - Ø 6 - T15	1
Z051.214.R	M 5x7 ch 2,5 for art. R155 e R159	1
Z051.308.R	M 3x6 - T9 - Ø 5,5	1
Z051.328.R	M 3x6 - T9 - Ø 4,7	1
Z051.400.R	M 4x6 for art. W178 - Ø 8	1
Z051.402.R	M 4x8 for art. W171/W176 - Ø 9	1
Z051.406.R	M 4x3,2 for art. W182	1
Z051.702.R	M 5x10 for art. TTL	1

SLOTTED CHEESE HEAD SCREWS

ART. Z051

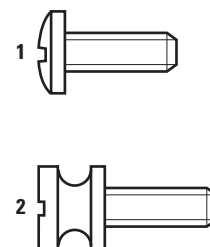

Item	Description	Draw.
Z051.501.R	M 3x4 for spare knife art. WC	1
Z051.503.R	M 3x10 for ball bearing art. WC	1
Z051.505.R	M 5x17 for machines Weeke	2

HEXAGON SOCKET SET SCREWS FOR WEDGES

ART. Z051

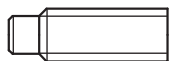

Item	Description	For item
Z051.800.R	M 5x18	TA/TB/TC
Z051.801.R	M 7x21	TB
Z051.802.R	M 8x21	THL
Z051.803.R	M 6x10	TI 120
Z051.804.R	M 6x12	TI 160
Z051.805.R	M 8x20	TLL
Z051.807.R	M 6x20	TYL
Z051.808.R	M 6x25	TWL
Z051.809.R	M 8x18	TZA
Z051.810.R	M 8x16	TEL
Z051.811.R	M 4x10 - Torx T15	TIL

ALLEN KEYS

ART. Z052



Item	Description
Z052.001.N	ch 1,9
Z052.002.N	ch 2,4
Z052.003.N	ch 4
Z052.005.N	ch 1,6
Z052.006.N	ch 2,5 for art. L001.100L/R
Z052.007.N	ch 1,5
Z052.013.N	ch 4,7 for art. R110.800.R
Z052.055.N	ch 1,6 and ch 2,5 for art. R156 and R159
Z052.101.N	ch 1,3
Z052.102.N	ch 2
Z052.103.N	ch 3 for art. W168
Z052.104.N	ch 4 for art. W168
Z052.406.N	ch 3 for art. SB080

TORX KEYS

ART. Z052



Item	Description
Z052.004.N	Torx T10
Z052.201.N	Torx T15
Z052.205.N	Torx T20
Z052.302.N	Torx T9

WRENCHES

ART. Z052

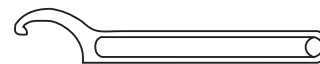

Item	Description	Collet nut
Z052.300.N	Wrench 34/38	DIN6388/EOC12
Z052.305.N	Wrench 45/50	Z091.005.R
Z052.301.N	Wrench 40/42	Z091.000.R
Z052.310.N	Wrench 58/62	DIN6388/EOC25
Z052.314.N	Wrench for Tornado D=80	
Z052.315.N	Wrench for Tornado D=92	

WRENCHES FOR COLLET NUT "STANDARD"

ART. Z052

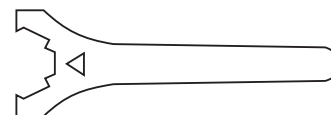

Item	Description
Z052.401.N	Wrench for collet nut ER 32 "standard" type
Z052.402.N	Wrench for collet nut ER 40 "standard" type
Z052.404.N	Wrench for collet nut ER 20 "standard" type
Z052.407.N	Wrench for collet nut ER 25 "standard" type
Z052.409.N	Wrench for collet nut ER 16 "standard" type

WRENCHES FOR COLLET NUT "MINI"

ART. Z052

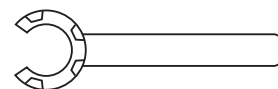

Item	Description
Z052.503.N	Wrench for collet nut ER 25 "mini" type
Z052.505.N	Wrench for collet nut ER 16 "mini" type
Z052.508.N	Wrench for collet nut ER 20 "mini" type
Z052.511.N	Wrench for collet nut ER 11 "mini" type

TORQUE WRENCHES

Why should I use a torque wrench?

While setting a tool it is extremely important to tighten it appropriately. If not effectively tight indeed a cutting tool could slide away from the tool holder during the working process. On the other side, an excessive tightening can cause damages to the tool holder or spring collet or the tool itself.

How to use

Turn the handle to choose the correct torque power based on the router bits diameter. While tightening with constant action a strong shot is perceived both mechanically and acoustically. This indicates that the tightening torque is reached.

- Adjustable torque wrench is suitable for fastening and tightening Klein® nuts and collets properly. Use them every day in order to reach a longer tool life and better cutting performance.
- Permissible deviation/tolerance (according to DIN ISO 6789): pm 4%
- While setting a tool it is **extremely important to tighten it appropriately**. If not effectively tight indeed, cutting tool could slide away from the tool holder during the working process. On the other side an excessive tightening can cause damages to the tool holder or spring collet or the tool itself.
- The wrench indicates when the torque (Nm) is reached with a strong noise according to the value in the corresponding table.
- **Each torque wrench is supplied in its own cardboard box with instruction sheet and calibration test report unique for each wrench.**

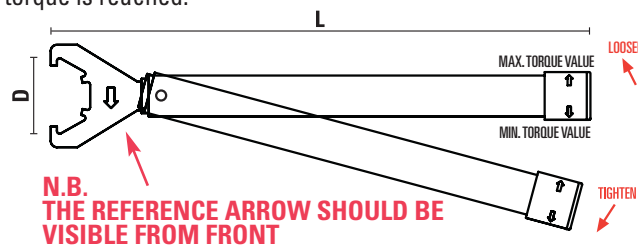

- Dr. ① Collets as per drawing n. 1 must be tightened by setting the minimum torque value and rotating the handle counterclockwise.
- Dr. ② Collets as per drawing n. 2 must be tightened by setting the maximum torque value and rotating the handle clockwise.

TORQUE WRENCHES FOR "MINI" NUTS

ART. Z052

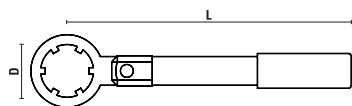

Item	D	L	Nm	Threaded nut
Z052.701.N	16	120	18	ER11
Z052.702.N	22	175	28	ER16
Z052.703.N	28	180	35	ER20
Z052.704.N	35	185	40	ER25

TORQUE WRENCHES FOR "STANDARD" NUTS

ART. Z052

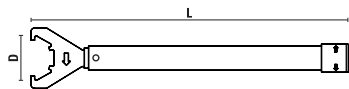

Item	D	L	Nm (Dr. 1)	Nm (Dr. 2)	Threaded nut
Z052.710.N	32	380	25-35	45-55	ER16
Z052.711.N	35	380	30-40	60-70	ER20
Z052.712.N	40	400	40-55	80-90	ER25
Z052.713.N	50	400	66-70	120-130	ER32
Z052.714.N	63	450	110-120	190-200	ER40

TORQUE WRENCHES FOR TORNADO®

ART. Z052



Item	Type	L	Nm (dis. 1)	Nm (dis. 2)
Z052.722.N	ER25	480	40-55	80-90
Z052.723.N	ER32	480	66-70	120-130
Z052.724.N	ER40	480	110-120	190-200
Z052.728.N	EOC25	480	110-120	190-200

TORQUE HOOK WRENCHES

ART. Z052

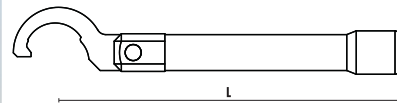

Item	D	L	Nm (Dr. 1)	Nm (Dr. 2)	Threaded nut
Z052.732.N	58-62	380	110-120	190-200	DIN 6388/EOC25
Z052.735.N	50	380	110-120	190-200	Z091.005.R

TORQUE WRENCHES FOR "NO-NOISE" NUTS

ART. Z052

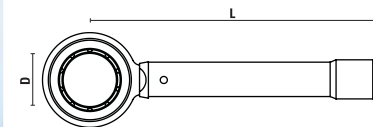

Item	D	L	Nm (Dr. 1)	Nm (Dr. 2)	Threaded nut
Z052.790.N	32	400	25-35	45-55	ER 16
Z052.793.N	50	400	65-70	120-130	ER 32
Z052.795.N	60	400	110-120	190-200	DIN 6388/EOC25

While tightening with constant action a strong shot is perceived both mechanically and acoustically. This indicates that the set torque is reached.

TORQUE WRENCHES FOR "TORX" SCREWS

ART. Z052

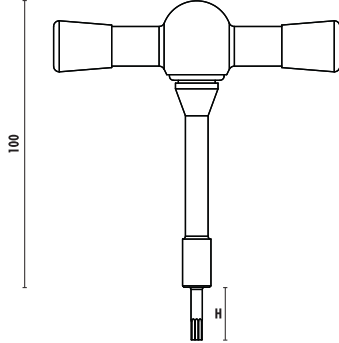

H=50 Spare bits



H=25



Supplied with H=25

Item	Torx	Nm
Z052.748.N	T6	0,6
Z052.749.N	T7	0,9
Z052.750.N	T8	1,2
Z052.751.N	T9	1,4
Z052.752.N	T10	2
Z052.753.N	T15	3
Z052.754.N	T20	5
Z052.755.N	T25	7,2

Spare parts	Torx	H
Z052.748.NCH25	T6	25
Z052.749.NCH25	T7	25
Z052.750.NCH25	T8	25
Z052.750.NCH50	T8	50
Z052.751.NCH25	T9	25
Z052.751.NCH50	T9	50
Z052.752.NCH25	T10	25
Z052.752.NCH50	T10	50
Z052.753.NCH25	T15	25
Z052.753.NCH50	T15	50
Z052.754.NCH25	T20	25
Z052.754.NCH50	T20	50
Z052.755.NCH25	T25	25
Z052.755.NCH50	T25	50

Insert bits in 5 pieces box

TORQUE WRENCHES FOR "HEX" SCREWS

ART. Z052

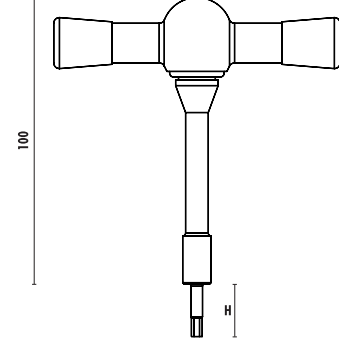

Spare bits

H=25



Supplied with H=25

Item	Socket size	Nm	Used on screw
Z052.771.N	1,3	0,10	Z051.101.R
Z052.772.N	1,5	0,12	Z051.404.R
Z052.773.N	2	0,50	Z051.001.R
Z052.774.N	2,4	0,76	Z051.002.R
Z052.775.N	4	3,10	Z051.004.R
Z052.776.N	5	5,00	Z051.016.R
Z052.785.N	1,6	3,00	Z051.005.R
Z052.786.N	2,5	5,00	Z051.301.R
Z052.787.N	3	7,00	Z051.314.R

Spare parts	Socket size
Z052.771.NCH25	1,3
Z052.772.NCH25	1,5
Z052.773.NCH25	2
Z052.774.NCH25	2,4
Z052.775.NCH25	4
Z052.776.NCH25	5
Z052.785.NCH25	1,6
Z052.786.NCH25	2,5
Z052.787.NCH25	3

Insert bits in 5 pieces box

WASHERS

ART. Z053



Item	D	d
Z053.001.N	9,5	3,2
Z053.002.N	8	4,8
Z053.003.N	12,7	4,8
Z053.004.N	16	5
Z053.010.N	9,5	6,4

SPRING WASHERS

ART. Z054



Item	D	d
Z054.001.N	6	2,5
Z054.002.N	7,5	3,2
Z054.003.N	11	6,4
Z054.410.N	9,5	6,4

KNIVES

ART. Z055

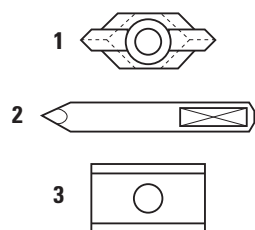

10 pcs. set

Item	Drawing	
Z055.100.N	1	spur
Z055.101.N	2	centerpoint
Z055.125.N	3	HW-knife for Ø25
Z055.126.N	3	HW-knife for Ø26
Z055.130.N	3	HW-knife for Ø30
Z055.135.N	3	HW-knife for Ø35
Z055.140.N	3	HW-knife for Ø40

HW "VERSOFIX" KNIVES

ART. Z055

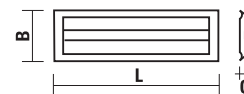

10 pcs. set

- With "Kawedur" coating
- 4 cutting edges
- Spare parts for W120-W127 and W138

Item	L	B	C
Z055.220.N	20	5,5	1,1
Z055.221.N	20	10	1,5
Z055.230.N	30	6,5	1,1
Z055.231.N	30	10	1,5
Z055.250.N	50	10	1,5

HW STANDARD REVERSIBLE KNIVES

ART. Z055

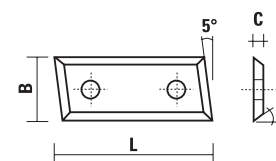

10 pcs. set

- 4 cutting edges
- 2 fixing holes
- 5° right
- Spare parts for Art. W153 - W154 - W155 - W156

Item	Grade	L	B	C	α
Z055.423.N	HC05	30	9	1,5	35°
Z055.424.N	HC05	40	9	1,5	35°
Z055.425.N	HC05	50	9	1,5	35°
Z055.430.N	HC05	30	12	1,5	35°
Z055.440.N	HC05	40	12	1,5	35°
Z055.450.N	HC05	50	12	1,5	35°

HW KNIVES

ART. Z055

Item	Description	For item
Z055.330.N	29,5x9x1,5	WC101
Z055.500.R	50x5,5x1,1	W174 - W175
Z055.500.L	50x5,5x1,1 Sx	W174 - W175
Z055.501.N	16x7x1,5 (1 chip breaker)	W172 - W173
Z055.502.N	16x7x1,5 (2 chip breaker)	W172 - W173
Z055.503.N	23x7x1,5 (1 chip breaker)	W172 - W173
Z055.504.N	23x7x1,5 (2 chip breaker)	W172 - W173
Z055.505.N	48x12x1,5	W171
Z055.506.N	27x9x1,5	W170.210.R+260
Z055.507.N	28x12x1,5	W170.380.R
Z055.516.N	16x7x1,5	W165
Z055.528.N	28x7x1,5	W165
Z055.529.N	29,5x5,5x1,1	WE101.120.R
Z055.550.N	R= 6	WC111
Z055.551.N	20x9x1,5	WC120
Z055.552.N	13,25x9x1,1	WC121
Z055.553.N	R= 3/45°	WC122
Z055.554.N	R= 6	WC123
Z055.555.N	R= 6	WC125
Z055.556.N	R= 4,5	WC129
Z055.560.N	33,3x18,5x2	W178.860.R
Z055.562.N	32x20x1,5	W178.862.R
Z055.572.N	R= 6,4	WE112
Z055.573.N	R= 8	WE112
Z055.574.N	R= 9,5	WE112
Z055.575.N	R= 12,7	WE112
Z055.641.R	Profile C1 - 45°	W162
Z055.642.R	Profile C2 - R= 4/45°	W162
Z055.643.R	Profile C3 - R= 1/11	W162
Z055.644.R	Profile C4 - R= 3°	W162
Z055.645.R	Profile C5 - R= 8/30°	W162
Z055.646.R	Profile C6 - R= 4/2	W162
Z055.647.R	Profile C7 - R= 12	W162
Z055.648.R	Profile C8 - R= 3/2	W162
Z055.649.R	Profile C9 - R= 2/10	W162
Z055.650.R	Profile C10 - R= 45°/2	W162
Z055.651.R	Profile B1 - R= 12x4	W161
Z055.652.R	Profile B2 - R= 12	W161
Z055.653.R	Profile B3 - R= 15	W161
Z055.654.R	Profile B4 - R= 3/R3	W161
Z055.655.R	Profile B5 - R= 26/5	W161
Z055.656.R	Profile B6 - R= 6/1,5	W161
Z055.661.R	Profile A1 - R= 10/4	W160
Z055.662.R	Profile A2 - R= 6/6	W160
Z055.663.R	Profile A3 - R= 5/6	W160
Z055.664.R	Profile A4 - R= 15/14	W160
Z055.665.R	Profile A5 - R= 3/20°	W160
Z055.666.R	Profile A6 - R= 5/20°	W160

Item	Item	Description	For item
Z055.800.R	Z055.800.L	R= 2/45°	TLL
Z055.801.R	Z055.801.L	R= 3/45°	TLL
Z055.802.R	Z055.802.L	R= 4/45°	TLL
Z055.803.R	Z055.803.L	R= 5/45°	TLL
Z055.804.R	Z055.804.L	R= 6/45°	TLL
Z055.805.R		R= 3/6	TML
Z055.806.R		R= 4/8	TML
Z055.807.R		R= 5/10	TML
Z055.808.R		R= 12/18	TML
Z055.809.R		R= 15/20	TML
Z055.810.R		R= 4/4	TNL
Z055.811.R		R= 6/6	TNL
Z055.812.R		R= 8/8	TNL
Z055.813.R		R= 10/10	TNL
Z055.814.R		R= 12/12	TNL
Z055.815.R		R= 15/15	TNL
Z055.830.R		45°	TSL
Z055.831.N		Profile A	TTL
Z055.832.N		Profile B	TTL
Z055.833.N		Profile C	TTL
Z055.834.N		Profile D	TTL
Z055.835.N		Profile E	TTL
Z055.836.N		Profile F	TTL
Z055.841.R		Profile A	TVL
Z055.842.R		Profile B	TVL
Z055.843.N		Profile A	TWL
Z055.844.N		Profile B	TWL
Z055.845.N		Profile C	TWL
Z055.846.N		Profile D	TWL
Z055.847.N		Profile A4	TZL
Z055.848.N		Profile B4	TZL
Z055.851.R		Profile A1	TYL
Z055.852.R		Profile A2	TYL
Z055.853.R		Profile B1	TYL
Z055.854.R		Profile B2	TYL
Z055.855.R		Profile C1	TYL
Z055.856.R		Profile C2	TYL
Z055.857.R		Profile D1	TYL
Z055.858.R		Profile D2	TYL
Z055.859.R		Profile E1	TYL
Z055.860.R		Profile E2	TYL
Z055.861.N		Profile A1	TS
Z055.862.N		Profile A2	TS
Z055.863.N		Profile B1	TS
Z055.864.N		Profile B2	TS
Z055.870.R	Z055.870.L	R= 3	W184+W185
Z055.871.R	Z055.871.L	R= 4	W184+W185
Z055.872.R	Z055.872.L	R= 5	W184+W185
Z055.873.R	Z055.873.L	R= 6	W184+W185
Z055.874.R	Z055.874.L	R= 8	W184+W185
Z055.875.R	Z055.875.L	R= 10	W184+W185
Z055.876.R	Z055.876.L	45°	W184+W185

WEDGES

ART. Z056



Item	Description	For item
Z056.100.N	40x22,5x4	W180
Z056.101.N	40x13,5x8	W180/W181
Z056.102.N	L= 6,5	W182
Z056.700.N	L= 6,8	TA/TC
Z056.701.N	L= 14	TB
Z056.702.N	L= 46	TEL
Z056.703.N	L= 26	TF
Z056.704.N	45°	THL
Z056.705.N	L= 37	TI
Z056.706.N	L= 47	TI 160
Z056.707.N	wedge	TLL
Z056.708.N	wedge	TLL
Z056.709.N	D= 112/113	TML
Z056.710.N	D= 109/132	TML
Z056.711.N	D= 122	TNL
Z056.712.N	R= 8/9/10	TOL
Z056.719.N	45°	TSL
Z056.721.N	for profile A	TVL
Z056.722.N	for profile B	TVL
Z056.723.N	for profiles A/B/C/D	TWL
Z056.724.N	for profiles A1/B1/C1/D1/E1	TYL
Z056.725.N	for profiles A2/B2/C2/D2/E2	TYL
Z056.726.N	L= 46	TS
Z056.760.N	L= 120	TZA
Z056.761.N	L= 130	TZA
Z056.762.N	L= 150	TZA
Z056.763.N	L= 180	TZA
Z056.764.N	L= 230	TZA
Z056.765.N	L= 38	W168
Z056.790.N	38x24x13	SA
Z056.791.N	38x15x16	SA
Z056.800.N	wedges	TSL/THL

SPACERS

ART. Z057

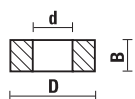

Item	D	d	B
Z057.001.N	16	7,94	3,6
Z057.002.N	16	7,94	1
Z057.003.N	16	7,94	0,5
Z057.004.N	16	7,94	0,1
Z057.005.N	16	7,94	3
Z057.006.N	16	7,94	6
Z057.007.N	16	7,94	0,4
Z057.008.N	16	7,94	0,05
Z057.009.N	16	7,94	5,3
Z057.010.N	9,5	6,4	2,2
Z057.101.N	10	6	1
Z057.102.N	10	6	1,5
Z057.103.N	10	6	3

LOCK RING

ART. Z058

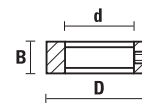

Item	D	d	B
Z058.001.N	11	6,4	5
Z058.002.N	18,2	12,7	6
Z058.003.N	20	12,7	6

O-RING

ART. Z059



Item	D	Rotation
Z059.001.L	8,5	Left (red color)
Z059.001.R	8,5	Right (black color)

SPRINGS

ART. Z060

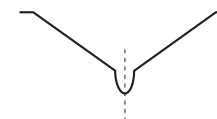

Item	Description	For item
Z060.100.N	36x95	TZA

THREADED RINGS

ART. Z060

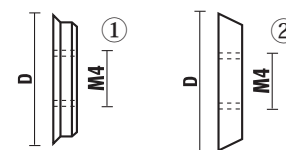

Item	Description	For item	Drawing
Z060.700.R	thread M4/10	TA	1
Z060.701.R	thread M4/12	TA	2
Z060.750.R	thread M4/12	W182	2
Z060.751.R	thread M4/10	W182	1

THREADED NUTS FOR MK2 SHANKS

ART. Z090

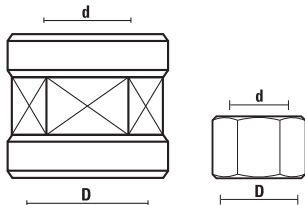

RH rotation	LH rotation	D	d	Wrench
Z090.001.R	Z090.001.L	M33x3	∅20/14x1"	38
Z090.002.R	Z090.002.L	M33x3	M30x1,5	38
Z090.011.R		1"1/8"x7G8	∅20/14x1"	38
Z090.012.R	Z090.012.L	1"1/8"x7G9	M30x1,5	38

COLLET NUTS

ART. Z091

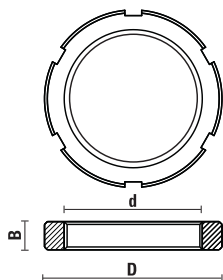

For Art. T118.953.R/T118.956.R/T118.959.R

Item	D	B	d	Rotation
Z091.902.R	63	10	M 50x1,5	RH

"NO-NOISE" COLLET NUTS

ART. Z091

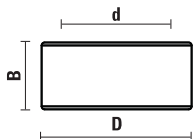

- Recommended when using router bits working at higher RPM
- Threaded nut with ground contours, remarkable reduction of noise

Item	Type	D	B	d	Rot.
Z091.501.R	DIN 6499 (ER 32)	50	23	M 40x1,5	RH
Z091.505.R	DIN 6499 (ER 16)	32	17,5	M 22x1,5	RH
Z091.522.R	DIN 6499 (EOC 25)	60	30	M 48x2	RH

COLLET NUTS

ART. Z091

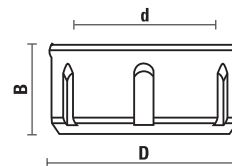

Item	Type	D	B	d	Rot.
Z091.000.R	For spring collets Art. T117	40	20	M 30x1,5	RH
Z091.000.L	For spring collets Art. T117	40	20	M 30x1,5	LH
Z091.001.R	DIN 6499 (ER 32)	50	23	M 40x1,5	RH
Z091.001.L	DIN 6499 (ER 32)	50	23	M 40x1,5	LH
Z091.002.R	DIN 6499 (ER 40)	63	25	M 50x1,5	RH
Z091.002.L	DIN 6499 (ER 40)	63	25	M 50x1,5	LH
Z091.005.R	For spring collets T133	50	23	M 40x1,5	RH
Z091.103.R	DIN 6499 (ER 25)	42	20	M 32x1,5	RH
Z091.104.R	DIN 6499 (ER 20)	35	19	M 25x1,5	RH
Z091.105.R	DIN 6499 (ER 16)	32	17,5	M 22x1,5	RH
Z091.202.R	DIN 6388 (EOC25)	60	30	M 48x2	RH
Z091.205.R	DIN 6388 (EOC12)	35	28	M 27x1,5	RH
Z091.301.R	ETS 32	50	22	M 40x1,5	RH
Z091.302.R	ETS 40	63	25	M 50x1,5	RH
Z091.403.R	ER 25 Type mini	35	20	M 30x1	RH
Z091.403.L	ER 25 Type mini	35	20	M 30x1	LH
Z091.404.R	ER 20 Type mini	28	19	M 24x1	RH
Z091.405.R	ER 16 Type mini	22	18	M 19x1	RH
Z091.406.R	ER 11 Type mini	16	12	M 13x0,75	RH

COLLET NUTS WITH BALL BEARINGS

ART. Z091

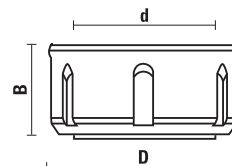
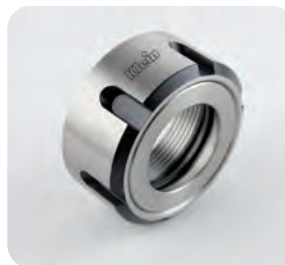

- The ball bearing clamping nut **improves the clamping precision** thanks to a **homogeneous clamping force**
- Easy and fast removal of the collet from the nut
- It can be used **both for right-hand and left-hand rotation**

Item	Type	D	B	d	Rot.
Z091.100.R	DIN 6499 (ER 25)	42	20	M 32x1,5	RH/LH
Z091.101.R	DIN 6499 (ER 32)	50	26	M 40x1,5	RH/LH
Z091.102.R	DIN 6499 (ER 40)	63	29	M 50x1,5	RH/LH
Z091.203.R	DIN 6388 (EOC25)	60	30	M 48x2	RH/LH

CLAMPING NUT WITH ECCENTRIC RING

ART. Z091

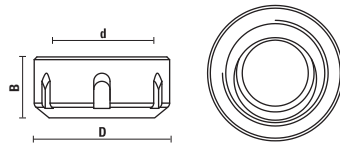

- To be used with our water-tight collets (Items T119/T123 NTS) at page 7.26 and stainless steel collet chucks at page 7.23 of our Catalog
 - Suitable when working with coolant

Item	Type	D	B	d	Rot.
Z091.051.R	DIN 6499 (ER 32)	50	23	M 40x1,5	RH
Z091.052.R	DIN 6499 (ER 40)	63	25	M 50x1,5	RH

END CAPS

ART. Z092

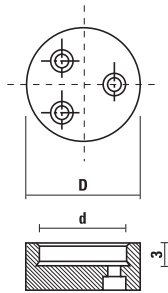

Hollow end cap (FF)

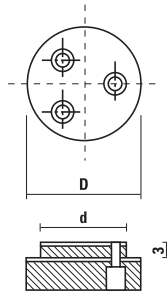

Extended end cap (FP)

Use on arbors Art. T128

Item	d	D	Type
Z092.001.R	30	40	FF
Z092.002.R	30	40	FP
Z092.003.R	35	50	FF
Z092.004.R	35	50	FP
Z092.005.R	40	50	FF
Z092.006.R	40	50	FP
Z092.007.R	25,4 (1")	50	FF
Z092.008.R	25,4 (1")	50	FP
Z092.009.R	31,75 (1/4")	50	FF
Z092.010.R	31,75 (1/4")	50	FP

LIFTING FLANGE FOR CUTTER ARBORS

ART. Z092

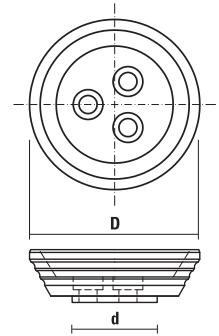

It mounts in place of the standard end cap to simplify the handling of heavy cutter stock

Item	d	D
Z092.030.N NEW	40	80

FIXING FLANGE FOR ART. T132.320.NS

ART. Z092

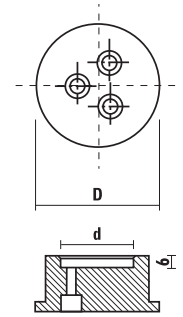

Hollow end cap (FF)

Use on arbors Art. T132.320.NS

Item	d	D	Type
Z092.050.R	40	80	FF

REDUCTION RINGS FOR SAWBLADES

ART. ZA000

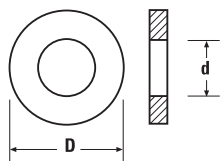

Item	D	d
ZA000.02012	20	12,7
ZA000.02013 Selling out	20	13
ZA000.02015 Selling out	20	15
ZA000.02016	20	16
ZA000.03015 Selling out	30	15
ZA000.03016	30	16
ZA000.03020	30	20
ZA000.03025	30	25
ZA000.03026	30	25,4
ZA000.03028 Selling out	30	28,6
ZA000.03220	32	20
ZA000.03230	32	30
ZA000.03516	35	16
ZA000.03520	35	20
ZA000.03526	35	26
ZA000.03530	35	30
ZA000.03532	35	32
ZA000.04030	40	30
ZA000.04032	40	32
ZA000.04035	40	35

REDUCTION RINGS FOR CUTTERHEADS

ART. ZA010

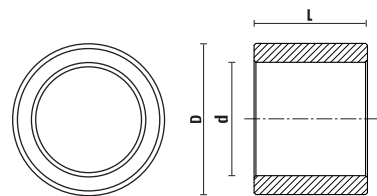

Tolerance:

D= 0/- 0,02

d= + 0,02/0

L= ± 0,02

Item	D	d	L
ZA010.322020	32	20	20
ZA010.353005	35	30	5
ZA010.353010	35	30	10
ZA010.353015	35	30	15
ZA010.353020	35	30	20
ZA010.353025	35	30	25
ZA010.353030	35	30	30
ZA010.353035	35	30	35
ZA010.353040	35	30	40
ZA010.403005	40	30	5
ZA010.403010	40	30	10
ZA010.403015	40	30	15
ZA010.403020	40	30	20
ZA010.403025	40	30	25
ZA010.403030	40	30	30
ZA010.403035	40	30	35
ZA010.403040	40	30	40
ZA010.403505	40	35	5
ZA010.403510	40	35	10
ZA010.403515	40	35	15
ZA010.403520	40	35	20
ZA010.403525	40	35	25
ZA010.403530	40	35	30
ZA010.403535	40	35	35
ZA010.403540	40	35	40

REDUCING BUSHES

ART. ZA011

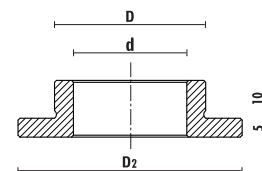

Tolerance:

D= 0/- 0,02

d= + 0,02/0

Item	D	d	D2
ZA011.03530	35	30	55
ZA011.04030	40	30	60
ZA011.04035	40	35	55
ZA011.05030	50	30	70
ZA011.05035	50	35	70
ZA011.05040	50	40	70

VISIT OUR WEBSITE

www.sistemiklein.com



SPACERS

ART. YD300 - YD350 - YD400 - YD500 - YD600

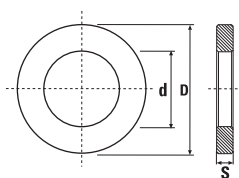

- For arbors Art. T128 - Art. T130 - Art. T131 - Art. T132
- Burnished
- Spacer rings fine-blanking processed for thickness 0,1÷1 mm (tolerance $\pm 0,02$)
- Spacer rings grinded on two sides for thickness 2÷50 mm (tolerance $\pm 0,01$)

Item	D	d	S
YD300.001	30	50	0,1
YD300.002	30	50	0,2
YD300.005	30	50	0,5
YD300.010	30	50	1
YD300.020	30	50	2
YD300.030	30	50	3
YD300.040	30	50	4
YD300.050	30	50	5
YD300.060	30	50	6
YD300.080	30	50	8
YD300.100	30	50	10
YD300.120	30	50	12
YD300.150	30	50	15
YD300.200	30	50	20
YD300.250	30	50	25
YD300.300	30	50	30
YD300.400	30	50	40
YD300.500	30	50	50
YD350.001	35	55	0,1
YD350.002	35	55	0,2
YD350.005	35	55	0,5
YD350.010	35	55	1
YD350.020	35	55	2
YD350.030	35	55	3
YD350.040	35	55	4
YD350.050	35	55	5
YD350.060	35	55	6
YD350.080	35	55	8
YD350.100	35	55	10
YD350.120	35	55	12
YD350.150	35	55	15
YD350.200	35	55	20
YD350.250	35	55	25
YD350.300	35	55	30
YD350.400	35	55	40
YD350.500	35	55	50

Item	D	D1	S
YD400.001	40	60	0,1
YD400.002	40	60	0,2
YD400.005	40	60	0,5
YD400.010	40	60	1
YD400.020	40	60	2
YD400.030	40	60	3
YD400.040	40	60	4
YD400.050	40	60	5
YD400.060	40	60	6
YD400.080	40	60	8
YD400.100	40	60	10
YD400.120	40	60	12
YD400.150	40	60	15
YD400.200	40	60	20
YD400.250	40	60	25
YD400.300	40	60	30
YD400.400	40	60	40
YD400.500	40	60	50
YD500.001	50	70	0,1
YD500.002	50	70	0,2
YD500.005	50	70	0,5
YD500.010	50	70	1
YD500.020	50	70	2
YD500.030	50	70	3
YD500.040	50	70	4
YD500.050	50	70	5
YD500.060	50	70	6
YD500.080	50	70	8
YD500.100	50	70	10
YD500.120	50	70	12
YD500.150	50	70	15
YD500.200	50	70	20
YD500.250	50	70	25
YD500.300	50	70	30
YD500.400	50	70	40
YD500.500	50	70	50
YD600.001	60	80	0,1
YD600.002	60	80	0,2
YD600.005	60	80	0,5
YD600.010	60	80	1
YD600.020	60	80	2
YD600.030	60	80	3
YD600.040	60	80	4
YD600.050	60	80	5
YD600.060	60	80	6
YD600.080	60	80	8
YD600.100	60	80	10
YD600.120	60	80	12
YD600.150	60	80	15
YD600.200	60	80	20
YD600.250	60	80	25
YD600.300	60	80	30
YD600.400	60	80	40
YD600.500	60	80	50



SPACERS SET

ART. YD300 - YD350 - YD400 - YD500 - YD600

Item	D	D1
YD300.990	30	50
YD350.990	35	55
YD400.990	40	60
YD500.990	50	70
YD600.990	60	80

Complete with:

- nr. 4 sp. 2 mm - nr. 3 sp. 4 mm - nr. 2 sp. 5 mm
- nr. 2 sp. 10 mm - nr. 1 sp. 20 mm - nr. 1 sp. 30 mm

REVERSIBLE KNIVES AND KNIVES FOR PLANERS



HW STANDARD REVERSIBLE KNIVES
Page 11.04

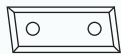

HW STANDARD REVERSIBLE KNIVES
Page 11.04

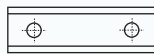

HW STANDARD REVERSIBLE KNIVES
Page 11.04



HW STANDARD REVERSIBLE KNIVES
Page 11.05



HW STANDARD REVERSIBLE KNIVES
Page 11.05

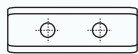

HW SPECIAL KNIVES
Page 11.05



HW SPECIAL KNIVES
Page 11.05



HW STANDARD REVERSIBLE KNIVES
Page 11.05



HW STANDARD REVERSIBLE KNIVES
Page 11.06



HW STANDARD REVERSIBLE KNIVES
Page 11.06

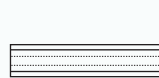

HW REVERSIBLE KNIVES "MINI"
Page 11.06



HW REVERSIBLE KNIVES "MINI"
Page 11.06

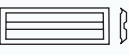

HW "VERSOFIX" KNIVES
Page 11.06



HW EDGE ROUNDING KNIVES
Page 11.06



HW STANDARD REVERSIBLE KNIVES
KleinDIA COATED
Page 11.08



HW STANDARD REVERSIBLE KNIVES
KleinDIA COATED
Page 11.08



HW STANDARD REVERSIBLE KNIVES
KleinDIA COATED
Page 11.08



HW STANDARD REVERSIBLE KNIVES
KleinDIA COATED
Page 11.08



HW STANDARD REVERSIBLE KNIVES
KleinDIA COATED
Page 11.08



HW SPECIAL KNIVES KleinDIA COATED
Page 11.08



HW SPECIAL KNIVES KleinDIA COATED
Page 11.09



HW STANDARD REVERSIBLE KNIVES
KleinDIA COATED
Page 11.09



HW STANDARD REVERSIBLE KNIVES
KleinDIA COATED
Page 11.09



HW STANDARD REVERSIBLE KNIVES
KleinDIA COATED
Page 11.09

KleinDIA



HW REVERSIBLE KNIVES "MINI" KleinDIA
COATED
Page 11.09

KleinDIA



HW EDGE ROUNDING KNIVES KleinDIA
COATED
Page 11.09



DP STANDARD REVERSIBLE KNIVES
Page 11.10



DP STANDARD REVERSIBLE KNIVES
Page 11.10

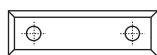

DP STANDARD REVERSIBLE KNIVES WITH 4
CUTTING EDGES
Page 11.10



DP 5° INCLINED REVERSIBLE KNIVES WITH
4 CUTTING EDGES
Page 11.10



DP STANDARD REVERSIBLE KNIVES
Page 11.10



KNIVES FOR PORTABLE PLANERS
Page 11.11



HW TURNBLADE KNIVES
FOR PORTABLE PLANERS
Page 11.11



LAMINATE CUTTERS
Page 11.12



PLANER KNIVES H=30/35 - HS=18% W
Page 11.12



PLANER KNIVES H=30/35 - HL=13% Cr
Page 11.13



PLANER KNIVES H=30/35 - HW=TCT
Page 11.13

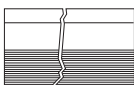

CORRUGATED BLANK KNIVES
Page 11.14



TURNBLADES "TERSA"
Page 11.15



TURNBLADES "CENTROLOCK"
Page 11.15



TURNBLADES "CENTROFIX
QUICKFIX" - "CENTROSTAR"
Page 11.15



TURNBLADES "TERMINUS"
Page 11.16



TURNBLADES "BULLDOZER"
Page 11.16



TURNBLADES "ENSHIN"
Page 11.16



TURNBLADES "SINUS"
Page 11.16



TURNBLADES "VARIPLAN"
Page 11.17



TURNBLADES "BRUCK"
Page 11.17



TURNBLADES "ESTA"
Page 11.18

REVERSIBLE KNIVES

Grades and application chart

Grades	Cobalt %	Density gr/cm ³	Hardness HV10	Resistance to breakage MPA	Softwood	Hardwood	Chipboard	MDF	HDF
Fine grain									
KCR06	3	15,30	1950	2600	XX	XX	XXX	XXX	XXX
KCR08	4,2	15,20	1920	2600	XXX	XXXX	XXX	XXX	XXX
MG06	3	15,35	2020	3300	XXX	XX	X	X	X
MG18	10	14,45	1570	3000	XXX	XXX	XX	XX	XX

Ultra fine grain									
KCR02+	2	15,35	2240	2500	-	-	XXXX	XXXX	XXXX

Nano grain									
UMG04	2,2	15,30	2500	3200	-	-	XX	XXXX	XXXX

X= fair
XX= good

XXX= very good
XXXX= excellent

KCR06 - KCR08

Covers 99% of all applications (soft and hard wood, melamine, HDF, MDF).
More precise cutting edge execution due to submicrograin grade.
High corrosion resistance due to special power mix.

MG18

By virtue of its micrograin structure MG18 is the optimum grade for 45° cutting edges. It creates a sharp, tough and wear resistant edge. This makes it ideal for machining hardwoods and brings the benefit of increased tool life.

KCR02+

This is an even harder micrograin grade giving an increase of 50% in tool life compared with MG06. It allows longer production running on MDF o HDF.

UMG04

Tests have shown tool life increased by 3 times compared to KCR02+ or 9 times the life of standard grades. For cutting very hard materials this is an economical alternative to DP tools with far less financial risk should breakage occur.

Grain size definition	Average grain size range
Nano grain	< 0,2 µm
Ultrafine grain	0,2 < 0,5 µm
Fine grain	0,5 < 0,8 µm



HW STANDARD REVERSIBLE KNIVES

ART. Z055 - Z155 - Z255 - Z355 - Z455 - Z555

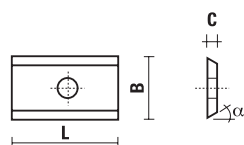

10 pcs. set

- 2 cutting edges
- 1 fixing hole

Item	Grade	L	B	C	α
Z555.000.N	KCR08	7,5	12	1,5	35°
Z555.012.N	KCR08	9,6	12	1,5	35°
Z555.002.N	KCR08	15	12	1,5	35°
Z555.003.N	KCR08	20	12	1,5	35°
Z555.014.N	KCR08	25	12	1,5	35°
Z055.013.N	KCR08	10,5	12	1,5	35°
Z055.900.N	KCR08	7,5	9	1,5	35°
Z055.901.N	KCR08	12	9	1,5	35°
Z055.903.N	KCR08	20	9	1,5	35°
Z155.003.N	MG06	20	12	1,5	35°
Z255.003.N	KCR02+	20	12	1,5	35°
Z355.003.N selling out	UMG04	20	12	1,5	35°
Z455.000.N selling out	MG18	7,5	12	1,5	45°
Z455.002.N selling out	MG18	15	12	1,5	45°
Z455.003.N	MG18	20	12	1,5	35°

HW STANDARD REVERSIBLE KNIVES

ART. Z055 - Z355

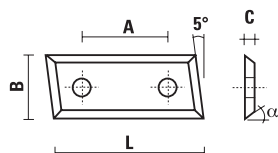

10 pcs. set

- 4 cutting edges
- 2 fixing holes
- 5° right

Item	Grade	L	B	C	α	A
Z055.423.N	KCR08	30	9	1,5	35°	14
Z055.424.N	KCR08	40	9	1,5	35°	26
Z055.425.N	KCR08	50	9	1,5	35°	26
Z055.430.N	KCR08	30	12	1,5	35°	14
Z055.440.N	KCR08	40	12	1,5	35°	26
Z055.450.N	KCR08	50	12	1,5	35°	26
Z355.450.N selling out	UMG04	50	12	1,5	35°	26

HW STANDARD REVERSIBLE KNIVES

ART. Z055 - Z155 - Z255 - Z355 - Z455 - Z555

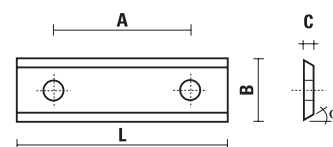

10 pcs. set

- 2 cutting edges
- 2 fixing holes

Item	Grade	L	B	C	α	A
Z555.015.N	KCR08	25	12	1,5	35°	14
Z555.008.N	KCR08	30	12	1,5	35°	14
Z555.009.N	KCR08	40	12	1,5	35°	26
Z555.010.N	KCR08	50	12	1,5	35°	26
Z555.011.N	KCR08	60	12	1,5	35°	26
Z555.070.N	KCR08	80	13	2,2	35°	60
Z555.071.N	KCR08	100	13	2,2	35°	60
Z555.072.N	KCR08	120	13	2,2	35°	60
Z055.070.N selling out	HC27	80	13	2,2	35°	60
Z055.071.N selling out	HC27	100	13	2,2	35°	60
Z055.072.N selling out	HC27	120	13	2,2	35°	60
Z055.908.N	KCR08	30	9	1,5	35°	14
Z055.909.N	KCR08	40	9	1,5	35°	26
Z055.910.N	KCR08	50	9	1,5	35°	26
Z155.008.N	MG06	30	12	1,5	35°	14
Z155.009.N	MG06	40	12	1,5	35°	26
Z155.010.N	MG06	50	12	1,5	35°	26
Z155.011.N	MG06	60	12	1,5	35°	26
Z255.008.N	KCR02+	30	12	1,5	35°	14
Z255.009.N	KCR02+	40	12	1,5	35°	26
Z255.010.N	KCR02+	50	12	1,5	35°	26
Z255.011.N	KCR02+	60	12	1,5	35°	26
Z355.008.N selling out	UMG04	30	12	1,5	35°	14
Z355.010.N selling out	UMG04	50	12	1,5	35°	26
Z455.008.N	MG18	30	12	1,5	45°	14
Z455.009.N	MG18	40	12	1,5	45°	26
Z455.010.N	MG18	50	12	1,5	45°	26
Z455.011.N	MG18	60	12	1,5	45°	26
Z455.980.N	MG18	80	13	2,2	45°	60

HW STANDARD REVERSIBLE KNIVES

ART. Z055

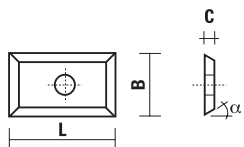

10 pcs. set

- 4 cutting edges
- 1 fixing hole

Item	Grade	L	B	C	α
Z055.319.N	KCR08	19,5	12	1,5	35°
Z055.320.N	KCR08	19,5	9	1,5	35°

HW STANDARD REVERSIBLE KNIVES

ART. Z055 - Z255 - Z355 - Z555

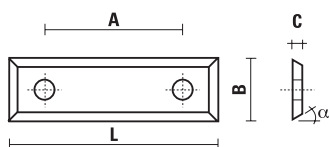

10 pcs. set

- 4 cutting edges
- 2 fixing holes

Item	Grade	L	B	C	α	A
Z055.110.N	KCR08	30	12	1,5	35°	14
Z055.330.N	KCR08	29,5	9	1,5	35°	14
Z055.341.N	KCR08	39,5	9	1,5	35°	26
Z055.350.N	KCR08	49,5	9	1,5	35°	26
Z255.329.N	KCR02+	29,5	12	1,5	35°	14
Z255.340.N	KCR02+	39,5	12	1,5	35°	26
Z255.349.N	KCR02+	49,5	12	1,5	35°	26
Z355.349.N selling out	UMG04	49,5	12	1,5	35°	26
Z555.329.N	KCR08	29,5	12	1,5	35°	14
Z555.340.N	KCR08	39,5	12	1,5	35°	26
Z555.350.N	KCR08	49,5	12	1,5	35°	26

HW SPECIAL KNIVES

ART. Z055

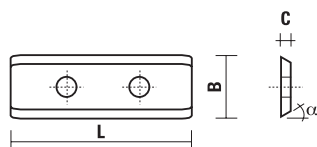

10 pcs. set

- 2 cutting edges
- 2 fixing holes

Item	Grade	L	B	C	α
Z055.033.N	KCR08	30	12	1,5	35°
Z055.035.N	KCR08	50	12	1,5	35°

HW SPECIAL KNIVES

ART. Z055

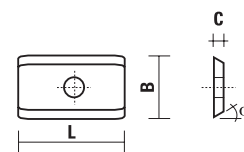

10 pcs. set

- 2 cutting edges
- 1 fixing hole

Item	Grade	L	B	C	α
Z055.032.N	KCR08	20	12	1,5	35°

HW STANDARD REVERSIBLE KNIVES

ART. Z055 - Z155 - Z255 - Z455 - Z555

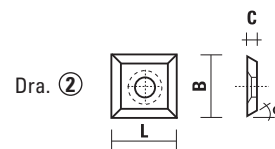
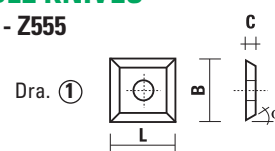
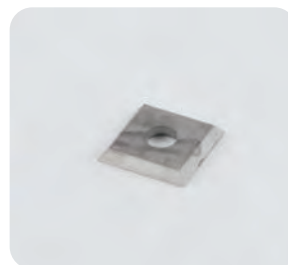

- 4 cutting edges
- 1 fixing hole

10 pcs. set

Item	Grade	Draw.	L	B	C	α
Z055.016.N	KCR08	1	10,5	10,5	1,5	35°
Z055.104.N	KCR08	1 R=2	12	12	1,5	35°
Z555.001.N	KCR08	1	12	12	1,5	35°
Z555.006.N	KCR08	2	14	14	1,2	30°
Z555.007.N	KCR08	2	14	14	2	30°
Z055.107.N	KCR08	2 R=2	14	14	2	30°
Z155.001.N	MG06	1	12	12	1,5	35°
Z155.007.N Selling out	MG06	2	14	14	2	30°
Z255.001.N	KCR02+	1	12	12	1,5	35°
Z255.007.N	KCR02+	2	14	14	2	30°
Z455.001.N Selling out	MG18	1	12	12	1,5	45°
Z455.007.N Selling out	MG18	2	14	14	2	45°

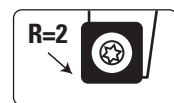

Z055.104.N
and
Z055.107.N

HW STANDARD REVERSIBLE KNIVES

ART. Z055

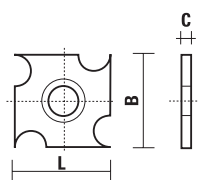
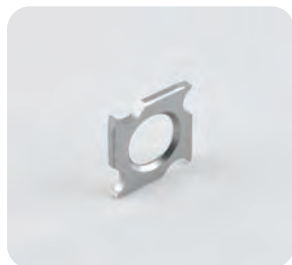

10 pcs. set

4 cutting edges

Item	Grade	L	B	C
Z055.020.N	KCR08	18	18	1,95
Z055.021.N	KCR08	18	18	2,45
Z055.022.N	KCR08	18	18	2,95

HW STANDARD REVERSIBLE KNIVES

ART. Z455

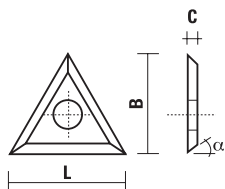

10 pcs. set

3 cutting edges

Item	Grade	L	B	C	α
Z455.030.N	KCR08	22	19	2	30°

HW REVERSIBLE KNIVES "MINI"

ART. Z055

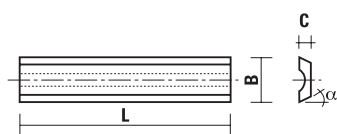

10 pcs. set

- 2 cutting edges
- Front groove

Item	Grade	L	B	C	α
Z055.080.N selling out	HC05	12	5,5	1,1	35°
Z055.082.N selling out	HC05	30	5,5	1,1	35°
Z055.083.N selling out	HC05	40	5,5	1,1	35°
Z055.084.N selling out	HC05	50	5,5	1,1	35°

HW REVERSIBLE KNIVES "MINI"

ART. Z055

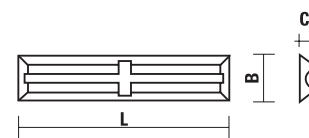

10 pcs. set

- 4 cutting edges
- Back groove with safety notch

Item	Grade	L	B	C	α
Z055.085.N	KCR06	20	4,1	1,1	35°
Z055.086.N	KCR06	20	5,5	1,1	35°
Z055.087.N	KCR06	25	5,5	1,1	35°
Z055.088.N	KCR06	30	5,5	1,1	35°
Z055.089.N	KCR06	50	5,5	1,1	35°

HW "VERSOFIX" KNIVES

ART. Z055



10 pcs. set

- With "Kawedur" coating
- 4 cutting edges
- Spare parts for W120÷W127 and W138

Item	L	B	C
Z055.220.N	20	5,5	1,1
Z055.221.N	20	10	1,5
Z055.230.N	30	6,5	1,1
Z055.231.N	30	10	1,5
Z055.250.N	50	10	1,5

HW EDGE ROUNDING KNIVES

ART. Z060

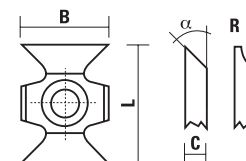
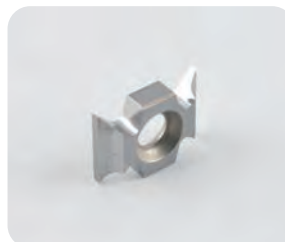

10 pcs. set

Item	Grade	L	B	C	α/R
Z060.000.N	MG18	22	16	5	45°
Z060.015.N	MG18	22	16	5	R=1,5
Z060.020.N	MG18	22	16	5	R=2
Z060.030.N	MG18	22	16	5	R=3
Z060.050.N	MG18	22	16	5	R=5

KleinDIA[®]

**DLC COATING FOR
EXCELLENT PERFORMANCE
AND LONGER LIFETIME**

KleinDIA[®] is the most advantageous coating, ensuring:

- Production increase
- Better finishing
- Less maintenance
- Longer lifetime

TECHNICAL FEATURES:

- High hardness Hv0,025: 2500-3100
- Higher wear resistance (longer working time)
- Low frictional coefficient (lowered working temperature)
- Very low sticking coefficient (Better chips evacuation)
- Thickness: appr. 1 micron
- Colour: bright black



SOFTWOOD - HARDWOOD



MDF - CHIPBOARD



VENEERED AND LAMINATES



ADVANCED MATERIALS



ALUMINIUM



PLASTIC MATERIAL
SOLID SURFACE



PLASTIC COATED



PLEXIGLASS

UP TO
4/6X
TOOL LIFE

HW STANDARD REVERSIBLE KNIVES Klein^{DIA} COATED

ART. Z055.KD

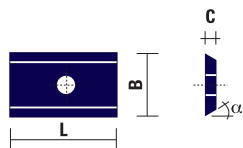
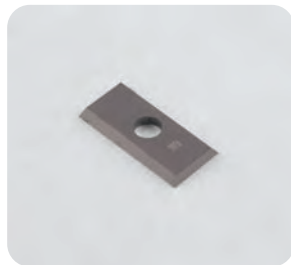

10 pcs. set

UP TO
4/6X
TOOL LIFE

- 2 cutting edges
- 1 fixing hole

Item	Grade	L	B	C	α
Z055.000.NKD	KCR08	7,5	12	1,5	35°
Z055.012.NKD	KCR08	9,6	12	1,5	35°
Z055.013.NKD	KCR08	10,5	12	1,5	35°
Z055.002.NKD <i>selling out</i>	KCR08	15	12	1,5	35°
Z055.003.NKD	KCR08	20	12	1,5	35°
Z055.014.NKD <i>selling out</i>	KCR08	25	12	1,5	35°
Z055.900.NKD	KCR08	7,5	9	1,5	35°
Z055.901.NKD	KCR08	12	9	1,5	35°
Z055.903.NKD	KCR08	20	9	1,5	35°

HW STANDARD REVERSIBLE KNIVES Klein^{DIA} COATED

ART. Z055.KD

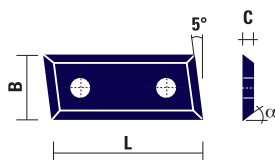

10 pcs. set

UP TO
4/6X
TOOL LIFE

- 4 cutting edges
- 2 fixing holes
- 5° right

item	Grade	L	B	C	α
Z055.423.NKD	KCR08	30	9	1,5	35°
Z055.424.NKD	KCR08	40	9	1,5	35°
Z055.425.NKD	KCR08	50	9	1,5	35°
Z055.430.NKD	KCR08	30	12	1,5	35°
Z055.440.NKD	KCR08	40	12	1,5	35°
Z055.450.NKD	KCR08	50	12	1,5	35°

HW STANDARD REVERSIBLE KNIVES Klein^{DIA} COATED

ART. Z055.KD

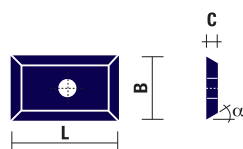
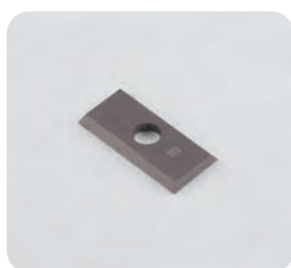

10 pcs. set

UP TO
4/6X
TOOL LIFE

- 4 cutting edges
- 1 fixing hole

Item	Grade	L	B	C	α
Z055.319.NKD	KCR08	19,5	12	1,5	35°
Z055.320.NKD	KCR08	19,5	9	1,5	35°

HW STANDARD REVERSIBLE KNIVES Klein^{DIA} COATED

ART. Z055.KD

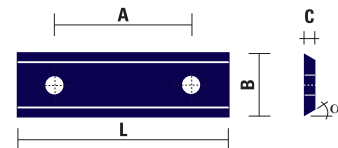

10 pcs. set

UP TO
4/6X
TOOL LIFE

- 2 cutting edges
- 2 fixing holes

Item	Grade	L	B	C	α	A
Z055.015.NKD <i>selling out</i>	KCR08	25	12	1,5	35°	14
Z055.008.NKD	KCR08	30	12	1,5	35°	14
Z055.009.NKD	KCR08	40	12	1,5	35°	26
Z055.010.NKD	KCR08	50	12	1,5	35°	26
Z055.011.NKD	KCR08	60	12	1,5	35°	26
Z055.908.NKD	KCR08	30	9	1,5	35°	14
Z055.909.NKD	KCR08	40	9	1,5	35°	26
Z055.910.NKD	KCR08	50	9	1,5	35°	26

HW STANDARD REVERSIBLE KNIVES Klein^{DIA} COATED

ART. Z055.KD

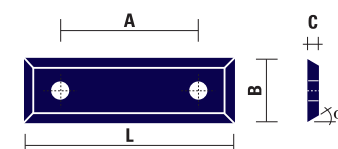

10 pcs. set

UP TO
4/6X
TOOL LIFE

- 4 cutting edges
- 2 fixing holes

item	Grade	L	B	C	α	A
Z055.329.NKD <i>selling out</i>	KCR08	29,5	12	1,5	35°	14
Z055.340.NKD <i>selling out</i>	KCR08	39,5	12	1,5	35°	26
Z055.349.NKD <i>selling out</i>	KCR08	49,5	12	1,5	35°	26
Z055.330.NKD	KCR08	29,5	9	1,5	35°	14
Z055.341.NKD	KCR08	39,5	9	1,5	35°	26
Z055.350.NKD	KCR08	49,5	9	1,5	35°	26

HW SPECIAL KNIVES Klein^{DIA} COATED

ART. Z055.KD

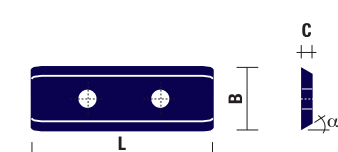

10 pcs. set

UP TO
4/6X
TOOL LIFE

- 2 cutting edges
- 2 fixing holes

Item	Grade	L	B	C	α
Z055.033.NKD	KCR08	30	12	1,5	35°
Z055.035.NKD	KCR08	50	12	1,5	35°

HW SPECIAL KNIVES Klein^{DIA} COATED

ART. Z055.KD

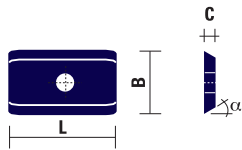

UP TO
4/6X
TOOL LIFE

- 2 cutting edges
- 1 fixing hole

10 pcs. set

Item	Grade	L	B	C	α
Z055.032.NKD	KCR08	20	12	1,5	35°

HW STANDARD REVERSIBLE KNIVES Klein^{DIA} COATED

ART. Z455.KD

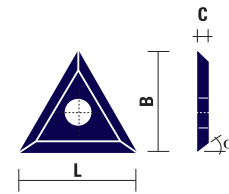
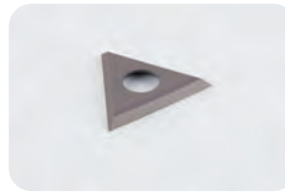

UP TO
4/6X
TOOL LIFE

3 cutting edges

10 pcs. set

Item	Grade	L	B	C	α
Z455.030.NKD	MG18	22	19	2	30°

HW STANDARD REVERSIBLE KNIVES Klein^{DIA} COATED

ART. Z055.KD

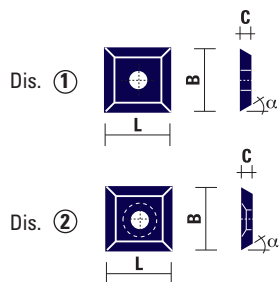
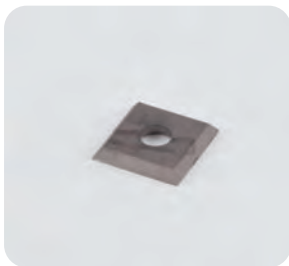

UP TO
4/6X
TOOL LIFE

- 4 cutting edges
- 1 fixing hole

10 pcs. set

Item	Grade	Drawing	L	B	C	α
Z055.016.NKD	KCR08	1	10,5	10,5	1,5	35°
Z055.001.NKD	KCR08	1	12	12	1,5	35°
Z055.006.NKD	KCR08	2	14	14	1,2	30°
Z055.007.NKD	KCR08	2	14	14	2	30°

HW REVERSIBLE KNIVES "MINI" Klein^{DIA} COATED

ART. Z055.KD

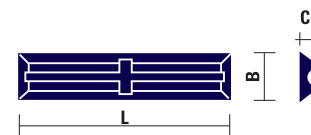

UP TO
4/6X
TOOL LIFE

- 4 cutting edges
- Back groove with safety notch

10 pcs. set

Item	Grade	L	B	C	α
Z055.088.NKD	HC05	30	5,5	1,1	35°
Z055.089.NKD	HC05	50	5,5	1,1	35°

HW STANDARD REVERSIBLE KNIVES Klein^{DIA} COATED

ART. Z055.KD

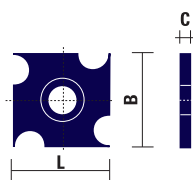
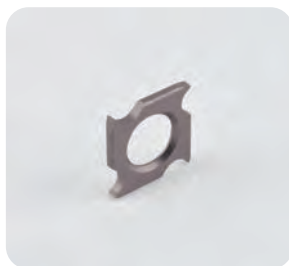

UP TO
4/6X
TOOL LIFE

4 cutting edges

10 pcs. set

Item	Grade	L	B	C
Z055.020.NKD	KCR08	18	18	1,95
Z055.021.NKD	KCR08	18	18	2,45
Z055.022.NKD	KCR08	18	18	2,95

HW EDGE ROUNDING KNIVES Klein^{DIA} COATED

ART. Z060.KD

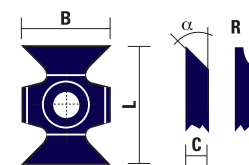
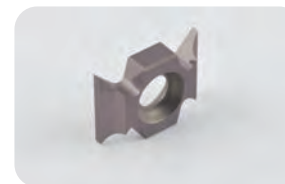

UP TO
4/6X
TOOL LIFE

10 pcs. set

Item	Grade	L	B	C	α/R
Z060.000.NKD	MG18	22	16	5	45°
Z060.015.NKD	MG18	22	16	5	R=1,5
Z060.020.NKD	MG18	22	16	5	R=2
Z060.030.NKD	MG18	22	16	5	R=3
Z060.050.NKD	MG18	22	16	5	R=5

DP STANDARD REVERSIBLE KNIVES

ART. XZ055

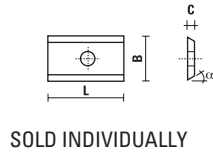

SOLD INDIVIDUALLY

UP TO
30/50X
TOOL LIFE

- These knives replace perfectly the HW standard knives
- **2 cutting edges**
- Lifetime up to 35/50 times longer compared to the HC05 (HW) knives
- 1 fixing hole
- Regrindable knives
- **CAUTION:** when sharpening a multicutter bit make sure that all the knives are mounted at the same height

Item	L	B	C	α	A
XZ055.000.N	7,5	12	1,5	35°	
XZ055.012.N	9,6	12	1,5	35°	
XZ055.002.N	15	12	1,5	35°	
XZ055.003.N	20	12	1,5	35°	
XZ055.014.N	25	12	1,5	35°	

DP STANDARD REVERSIBLE KNIVES

ART. XZ055

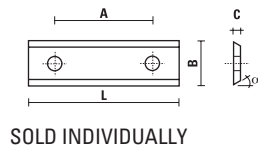

SOLD INDIVIDUALLY

UP TO
30/50X
TOOL LIFE

- These knives replace perfectly the HW standard knives
- **2 cutting edges**
- Lifetime up to 35/50 times longer compared to the HC05 (HW) knives
- 2 fixing hole
- Regrindable knives
- **CAUTION:** when sharpening a multicutter bit make sure that all the knives are mounted at the same height

Item	L	B	C	α	A
XZ055.008.N	30	12	1,5	35°	14
XZ055.009.N	40	12	1,5	35°	26
XZ055.010.N	50	12	1,5	35°	26
XZ055.011.N	60	12	1,5	35°	26

DP STANDARD REVERSIBLE KNIVES WITH 4 CUTTING EDGES

ART. XZ055

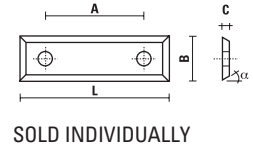

SOLD INDIVIDUALLY

UP TO
30/50X
TOOL LIFE

- These knives replace perfectly the HW standard knives
- **4 cutting edges**
- Lifetime up to 35/50 times longer compared to the HC05 (HW) knives
- 2 fixing hole
- Regrindable knives
- **CAUTION:** when sharpening a multicutter bit make sure that all the knives are mounted at the same height

Item	L	B	C	α	A
XZ055.329.N	29,5	12	1,5	35°	14
XZ055.340.N	39,5	12	1,5	35°	26
XZ055.349.N	49,5	12	1,5	35°	26

DP 5° INCLINED REVERSIBLE KNIVES WITH 4 CUTTING EDGES

ART. XZ055

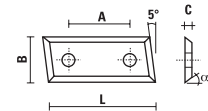

SOLD INDIVIDUALLY

UP TO
30/50X
TOOL LIFE

- These knives replace perfectly the HW standard knives
- **4 cutting edges**
- Lifetime up to 35/50 times longer compared to the HC05 (HW) knives
- **5° right-hand inclination**
- 2 fixing hole
- Regrindable knives
- **CAUTION:** when sharpening a multicutter bit make sure that all the knives are mounted at the same height

Item	L	B	C	α	A
XZ055.430.N	29,5	12	1,5	35°	14
XZ055.440.N	39,5	12	1,5	35°	26
XZ055.450.N	49,5	12	1,5	35°	26

DP STANDARD REVERSIBLE KNIVES

ART. XZ055

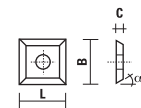
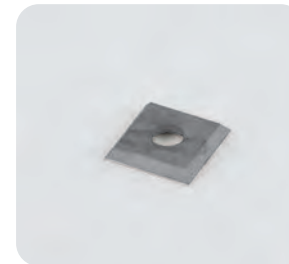

SOLD INDIVIDUALLY

UP TO
30/50X
TOOL LIFE

- **4 cutting edges**
- Lifetime up to 35/50 times longer compared to the HC05 (HW) knives
- 1 fixing hole
- Regrindable knives
- **CAUTION:** when sharpening a multicutter bit make sure that all the knives are mounted at the same height

Item	L	B	C	α
XZ055.001.N	12	12	1,5	35°

KNIVES FOR PORTABLE PLANERS

Item	L	H	S	Machine model
------	---	---	---	---------------

*Z081.021.N	80	27	3	HS Elu	
-------------	----	----	---	--------	---

*Z080.040.N	80	29	3	HW Star	
-------------	----	----	---	---------	---

Z080.050.N	82	29	3	HW Makita	
Z081.050.N	82	29	3	HS Makita	
Z080.052.N	110	29	3	HW Makita	

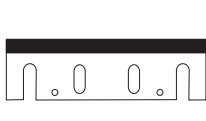
Z080.051.N	155	33	3	HW Makita	
Z081.051.N	155	33	3	HS Makita	
Z080.053.N	170	35	3	HW Makita	
Z081.053.N	170	35	3	HS Makita	

* Selling out

VISIT OUR WEBSITE
www.sistemklein.com



HW TURNBLADE KNIVES FOR PORTABLE PLANERS

ART. ZB



10 pcs. set

Item	Dimension	Producer	Machine model
ZB0755	75,5X5,5X1,1	AEG	HTH75
		BLACK & DECKER	DN75, 750SR, 600K
		BOSCH	0590, 1590, 1591, P400
		FESTO	REP75
		HAFFNER	FH222
		HOLZ-HER	2223, 2286, 2320
		KRESS	JET-STAR 6701, 6702
		MAFELL	HU75
		METABO	6375
		SCHEER	MH75/3, MH80
		SKIL	98H
ZB0805	80,5X5,9X1,2	ELU	MFF40, MFF80, PF161, MFF81, MFF81EK
ZB0820	82X5,5X1,1	AEG	EH450, EH825, EH700, EH700R
			EH822, H500, H750
		BLACK & DECKER	DN710, DN712, DN730
		BOSCH	PH0282, PH0382
		CASALS	CE82
		FEIN	HS2151
		FELISATTI	TP282
		HAFFNER	FH224
		HITACHI	F20, F20A, P20V, P20SA, FP20A
		HOLZ-HER	2223, 2321
		LEGNA	R82, G82
		MAFELL	MHU82
		MAKITA	1001, 1100, 1900, 1901, 1125B, 1923B, 1923H, 1923HO
		METABO	0882, 0883, E0983, 3360, 4382, 8382
		PERLES	HHB82B
		PEUGEOT	BRA3-82, BR82, RA400, 82RAC, RA1082CA
		SKIL	92H, 94H, 96H, 1506, 1510
		STAYER	980B
ZB0920	92X5,5X1,1	HITACHI	F30A
		RYOBI	L120N, 1323
		TOWA	
ZB1030	103X5,5X1,1	AEG	EH102, HB750, HBE800

2 PIECES HANGING PACKAGING

ZB0755X2	75x5,5x1,1
ZB0805X2	80,5x5,9x1,2
ZB0820X2	82x5,5x1,1
ZB0920X2	92x5,5x1,1
ZB1030X2	103x5,5x1,1



LAMINATE CUTTERS

ART. Y100



Item

Y100.001.R Selling out Two identical knives for cutting:
Plastic material, Laminates etc.

Y100.002.R Selling out Two identical knives for cutting:
Side A: Laminates etc.
Side B: Glass, Tiles etc.

MAGNETIC ALIGNERS FOR PLANER KNIVES

ART. Y200

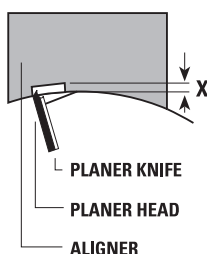

Klein magnetic aligners for planer knives have been specially designed for rapid knife positioning after sharpening. They are made of galvanized steel and feature permanent magnets.

In just a few minutes, in a simple and precise way, problems of knife alignment after sharpening are solved.

No adjustments are required. Simply position on cutterhead along the step where the knife is to be rested. All your knives will be parallel and positioned with the same working thickness.

Item	∅Planer head	X	Item	∅Planer head	X
Y200.056.N	56	1	Y200.095.N	95	1
Y200.060.N	60	1	Y200.100.N	100	1
Y200.063.N	63	1	Y200.110.N	110	1
Y200.070.N	70	1	Y200.118.N	118	1
Y200.075.N	75	1	Y200.120.N	120	1
Y200.080.N	80	1	Y200.125.N	125	1
Y200.086.N	86	1	Y200.140.N	140	1
Y200.090.N	90	1			



PLANER KNIVES H=30/35

ART. ZC 30 - ZC 35

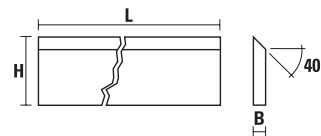
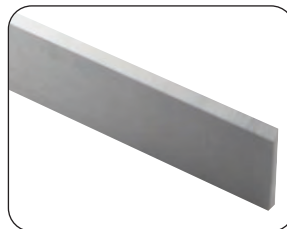

- HS= 18% W, suitable for softwood dry and hardwood wet
- 2 pcs. set

Item	Quality	H	B	L
ZC30.060HS	HS	30	3	60
ZC30.080HS	HS	30	3	80
ZC30.100HS	HS	30	3	100
ZC30.120HS	HS	30	3	120
ZC30.180HS	HS	30	3	180
ZC30.200HS	HS	30	3	200
ZC30.210HS	HS	30	3	210
ZC30.230HS	HS	30	3	230
ZC30.250HS	HS	30	3	250
ZC30.260HS	HS	30	3	260
ZC30.300HS	HS	30	3	300
ZC30.310HS	HS	30	3	310
ZC30.350HS	HS	30	3	350
ZC30.400HS	HS	30	3	400
ZC30.410HS	HS	30	3	410
ZC30.430HS	HS	30	3	430
ZC30.500HS	HS	30	3	500
ZC30.510HS	HS	30	3	510
ZC30.520HS	HS	30	3	520
ZC30.530HS	HS	30	3	530
ZC30.600HS	HS	30	3	600
ZC30.610HS	HS	30	3	610
ZC30.630HS	HS	30	3	630
ZC30.810HS	HS	30	3	810
ZC30.999HS	HS	30	3	1000
ZC35.300HS	HS	35	3	300
ZC35.310HS	HS	35	3	310
ZC35.350HS	HS	35	3	350
ZC35.400HS	HS	35	3	400
ZC35.410HS	HS	35	3	410
ZC35.430HS	HS	35	3	430
ZC35.500HS	HS	35	3	500
ZC35.510HS	HS	35	3	510
ZC35.520HS	HS	35	3	520
ZC35.530HS	HS	35	3	530
ZC35.600HS	HS	35	3	600
ZC35.630HS	HS	35	3	630
ZC35.640HS	HS	35	3	640
ZC35.700HS	HS	35	3	700
ZC35.810HS	HS	35	3	810
ZC35.999HS	HS	35	3	1000

PLANER KNIVES H=30/35

ART. ZC 30 - ZC 35

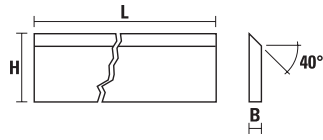
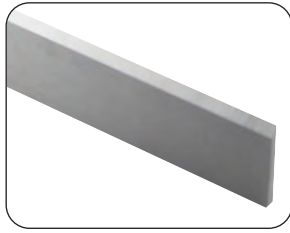

- HL= 13% Cr, suitable for softwood wet
- 2 pcs. set

Item	Quality	H	B	L
ZC35.300HL	HL	35	3	300
ZC35.350HL	HL	35	3	350
ZC35.400HL	HL	35	3	400
ZC35.410HL	HL	35	3	410
ZC35.430HL	HL	35	3	430
ZC35.500HL	HL	35	3	500
ZC35.510HL	HL	35	3	510
ZC35.520HL	HL	35	3	520
ZC35.530HL	HL	35	3	530
ZC35.600HL	HL	35	3	600
ZC35.610HL	HL	35	3	610
ZC35.630HL	HL	35	3	630
ZC35.640HL	HL	35	3	640
ZC35.740HL	HL	35	3	740
ZC35.810HL	HL	35	3	810
ZC35.999HL	HL	35	3	1000

PLANER KNIVES H=30/35

ART. ZC 30 - ZC 35

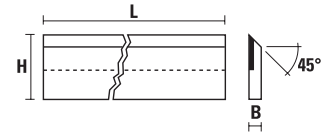
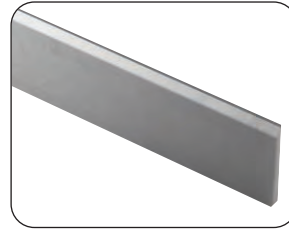

- HW= TCT
- 2 pcs. set
- Suitable for hardwood dry and pressed wood

Item	Quality	H	B	L
ZC30.080HW	HW	30	3	80
ZC30.100HW	HW	30	3	100
ZC30.120HW	HW	30	3	120
ZC30.130HW	HW	30	3	130
ZC30.150HW	HW	30	3	150
ZC30.180HW	HW	30	3	180
ZC30.200HW	HW	30	3	200
ZC30.230HW	HW	30	3	230
ZC30.250HW	HW	30	3	250
ZC30.260HW	HW	30	3	260
ZC30.310HW	HW	30	3	310
ZC30.350HW	HW	30	3	350
ZC30.400HW	HW	30	3	400
ZC30.410HW	HW	30	3	410
ZC30.450HW	HW	30	3	450
ZC30.500HW	HW	30	3	500
ZC30.520HW	HW	30	3	520
ZC30.530HW	HW	30	3	530
ZC30.600HW	HW	30	3	600
ZC30.630HW	HW	30	3	630
ZC30.710HW	HW	30	3	710
ZC30.810HW	HW	30	3	810
ZC30.999HW	HW	30	3	1040
ZC35.300HW	HW	35	3	300
ZC35.320HW	HW	35	3	320
ZC35.400HW	HW	35	3	400
ZC35.500HW	HW	35	3	500
ZC35.520HW	HW	35	3	520
ZC35.600HW	HW	35	3	600
ZC35.630HW	HW	35	3	630
ZC35.640HW	HW	35	3	640
ZC35.710HW	HW	35	3	710
ZC35.810HW	HW	35	3	810
ZC35.999HW	HW	35	3	1040

CORRUGATED BLANK KNIVES

ART. ZC 50 - ZC 60 - ZC 70

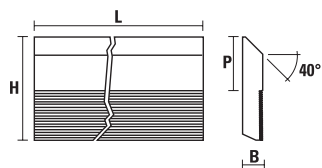

- **HS: 18% W**, suitable for softwood dry or wet and hardwood wet
- Precision serration, angle 60°, pitch 1,6 mm

Item	H	B	L	Pmax
ZC50.060HS	50	8	60	12
ZC50.080HS	50	8	80	12
ZC50.100HS	50	8	100	12
ZC50.120HS	50	8	120	12
ZC50.130HS	50	8	130	12
ZC50.150HS	50	8	150	12
ZC50.180HS	50	8	180	12
ZC50.230HS	50	8	230	12
ZC50.260HS	50	8	260	12
ZC50.650HS	50	8	650	12
ZC60.060HS	60	8	60	20
ZC60.080HS	60	8	80	20
ZC60.100HS	60	8	100	20
ZC60.120HS	60	8	120	20
ZC60.130HS	60	8	130	20
ZC60.150HS	60	8	150	20
ZC60.180HS	60	8	180	20
ZC60.230HS	60	8	230	20
ZC60.260HS	60	8	260	20
ZC60.650HS	60	8	650	20
ZC70.060HS	70	8	60	30
ZC70.080HS	70	8	80	30
ZC70.100HS	70	8	100	30
ZC70.120HS	70	8	120	30
ZC70.130HS	70	8	130	30
ZC70.150HS	70	8	150	30
ZC70.180HS	70	8	180	30
ZC70.230HS	70	8	230	30
ZC70.260HS	70	8	260	30
ZC70.650HS	70	8	650	30

CORRUGATED BLANK KNIVES

ART. ZC 50 - ZC 60 - ZC 70

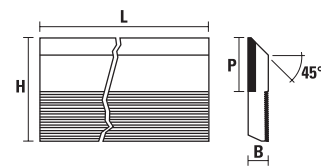
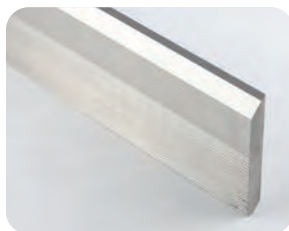

- **HW:** carbide tipped, suitable for hardwood dry, pressed wood
- Precision serration, angle 60°, pitch 1,6 mm

Item	H	B	L	Pmax
ZC50.040HW	50	8	40	20
ZC50.050HW	50	8	50	20
ZC50.060HW	50	8	60	20
ZC50.080HW	50	8	80	20
ZC50.100HW	50	8	100	20
ZC50.120HW	50	8	120	20
ZC50.130HW	50	8	130	20
ZC50.150HW	50	8	150	20
ZC50.180HW	50	8	180	20
ZC50.230HW	50	8	230	20
ZC50.640HW	50	8	640	20
ZC60.040HW	60	8	40	25
ZC60.050HW	60	8	50	25
ZC60.060HW	60	8	60	25
ZC60.080HW	60	8	80	25
ZC60.100HW	60	8	100	25
ZC60.120HW	60	8	120	25
ZC60.130HW	60	8	130	25
ZC60.150HW	60	8	150	25
ZC60.180HW	60	8	180	25
ZC60.230HW	60	8	230	25
ZC60.640HW	60	8	640	25
ZC70.040HW	70	8	40	30
ZC70.050HW	70	8	50	30
ZC70.060HW	70	8	60	30
ZC70.080HW	70	8	80	30
ZC70.100HW	70	8	100	30
ZC70.120HW	70	8	120	30
ZC70.130HW	70	8	130	30
ZC70.150HW	70	8	150	30
ZC70.180HW	70	8	180	30
ZC70.230HW	70	8	230	30
ZC70.640HW	70	8	640	30

TURNBLADES "TERSA"

ART. ZE 01

2 pcs. packaging

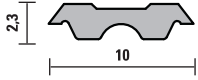

- Antioxidant treatment on knife body
- Polished cutting face for an excellent finish quality
- HS 18% for medium hard wood
- HW for very hard wood and abrasive materials
- M42 for hard wood, long-life performance

Item	Quality	L
ZE01.060HS	HS	60
ZE01.100HS	HS	100
ZE01.130HS	HS	130
ZE01.180HS	HS	180
ZE01.230HS	HS	230
ZE01.310HS	HS	310
ZE01.330HS	HS	330
ZE01.410HS	HS	410
ZE01.430HS	HS	430
ZE01.510HS	HS	510
ZE01.520HS	HS	520
ZE01.530HS	HS	530
ZE01.630HS	HS	630
ZE01.640HS	HS	640
ZE01.060HW	HW	60
ZE01.100HW	HW	100
ZE01.130HW	HW	130
ZE01.180HW	HW	180
ZE01.230HW	HW	230
ZE01.310HW	HW	310
ZE01.330HW	HW	330
ZE01.410HW	HW	410
ZE01.430HW	HW	430
ZE01.510HW	HW	510
ZE01.520HW	HW	520
ZE01.530HW	HW	530
ZE01.630HW	HW	630
ZE01.640HW	HW	640
ZE01.650HW	HW	650
ZE01.060M42	M42	60
ZE01.100M42	M42	100
ZE01.130M42	M42	130
ZE01.180M42	M42	180
ZE01.230M42	M42	230
ZE01.310M42	M42	310
ZE01.330M42	M42	330
ZE01.410M42	M42	410
ZE01.430M42	M42	430
ZE01.510M42	M42	510
ZE01.520M42	M42	520
ZE01.530M42	M42	530
ZE01.630M42	M42	630
ZE01.640M42	M42	640

Other dimensions available on request

TURNBLADES "CENTROLOCK"

ART. ZE 02

2 pcs. packaging

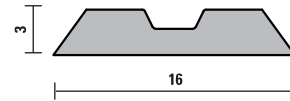

- Antioxidant treatment on knife body
- Polished cutting face for an excellent finish quality
- HS 18% for medium hard wood
- HW for very hard wood and abrasive materials

Item	Quality	L
ZE02.020HS	HS	20
ZE02.080HS	HS	80
ZE02.150HS	HS	150
ZE02.210HS	HS	210
ZE02.240HS	HS	240
ZE02.300HS	HS	300
ZE02.360HS	HS	360
ZE02.460HS	HS	460
ZE02.020HW	HW	20
ZE02.110HW	HW	110
ZE02.160HW	HW	160
ZE02.200HW	HW	200
ZE02.220HW	HW	220
ZE02.250HW	HW	250
ZE02.275HW	HW	275
ZE02.280HW	HW	280
ZE02.350HW	HW	350
ZE02.450HW	HW	450

TURNBLADES "CENTROFIX - QUICKFIX" - "CENTROSTAR"

ART. ZE 03

2 pcs. packaging

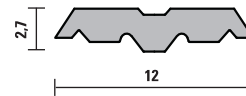

- Antioxidant treatment on knife body
- Polished cutting face for an excellent finish quality
- HS 18% for medium hard wood
- HW for very hard wood and abrasive materials

Item	Quality	L
ZE03.130HS	HS	130
ZE03.150HS	HS	150
ZE03.180HS	HS	180
ZE03.210HS	HS	210
ZE03.230HS	HS	230
ZE03.310HS	HS	310
ZE03.410HS	HS	410
ZE03.430HS	HS	430
ZE03.510HS	HS	510
ZE03.520HS	HS	520
ZE03.530HS	HS	530
ZE03.630HS	HS	630
ZE03.640HS	HS	640
ZE03.930HS	HS	930
ZE03.130HW	HW	130
ZE03.180HW	HW	180
ZE03.230HW	HW	230
ZE03.310HW	HW	310
ZE03.410HW	HW	410
ZE03.430HW	HW	430
ZE03.510HW	HW	510
ZE03.520HW	HW	520
ZE03.630HW	HW	630
ZE03.640HW	HW	640
ZE03.650HW	HW	650

Other dimensions available on request

TURNBLADES "TERMINUS"

ART. ZE 04

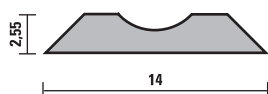

2 pcs. packaging

- Antioxidant treatment on knife body
- Polished cutting face for an excellent finish quality
- HS 18% for medium hard wood
- HW for very hard wood and abrasive materials

Item	Quality	L
ZE04.130HS	HS	130
ZE04.180HS	HS	180
ZE04.210HS	HS	210
ZE04.230HS	HS	230
ZE04.310HS	HS	310
ZE04.520HS	HS	520
ZE04.650HS	HS	650
ZE04.130HW	HW	130
ZE04.180HW	HW	180
ZE04.210HW	HW	210
ZE04.230HW	HW	230
ZE04.310HW	HW	310
ZE04.520HW	HW	520
ZE04.650HW	HW	650

Other dimensions available on request

TURNBLADES "BULLDOZER"

ART. ZE 05

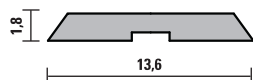

2 pcs. packaging

- Antioxidant treatment on knife body
- Polished cutting face for an excellent finish quality
- HW for very hard wood and abrasive materials

Item	Quality	L
ZE05.100HW	HW	100
ZE05.130HW	HW	130
ZE05.150HW	HW	150
ZE05.210HW	HW	210
ZE05.230HW	HW	230
ZE05.265HW	HW	265

Other dimensions available on request

TURNBLADES "ENSHIN"

ART. ZE 06

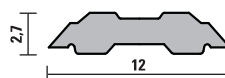

2 pcs. packaging

- Antioxidant treatment on knife body
- Polished cutting face for an excellent finish quality
- HS 18% for medium hard wood
- HW for very hard wood and abrasive materials

Item	Quality	L
ZE06.080HS	HS	80
ZE06.130HS	HS	130
ZE06.150HS	HS	150
ZE06.210HS	HS	210
ZE06.240HS	HS	240
ZE06.080HW	HW	80
ZE06.130HW	HW	130
ZE06.150HW	HW	150
ZE06.210HW	HW	210
ZE06.240HW	HW	240
ZE06.640HW	HW	640

Other dimensions available on request

TURNBLADES "SINUS"

ART. ZE 07

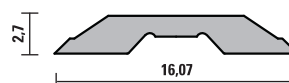

2 pcs. packaging

- Antioxidant treatment on knife body
- Polished cutting face for an excellent finish quality
- HS 18% for medium hard wood
- HW for very hard wood and abrasive materials

Item	Quality	L
ZE07.080HS	HS	80
ZE07.130HS	HS	130
ZE07.180HS	HS	180
ZE07.210HS	HS	210
ZE07.250HS	HS	250
ZE07.310HS	HS	310
ZE07.430HS	HS	430
ZE07.510HS	HS	510
ZE07.630HS	HS	630
ZE07.1050HS	HS	1050
ZE07.080HW	HW	80
ZE07.130HW	HW	130
ZE07.180HW	HW	180
ZE07.210.HW	HW	210
ZE07.250HW	HW	250
ZE07.310HW	HW	310
ZE07.430HW	HW	430
ZE07.510HW	HW	510
ZE07.630HW	HW	630

Other dimensions available on request

TURNBLADES "VARIPLAN"

ART. ZE 08

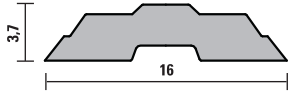

8 pcs. packaging

- Antioxidant treatment on knife body
- Polished cutting face for an excellent finish quality
- HS 18% for medium hard wood
- HW for very hard wood and abrasive materials

Item	Quality	L
ZE08.050HS	HS	50
ZE08.100HS	HS	100
ZE08.130HS	HS	130
ZE08.180HS	HS	180
ZE08.210HS	HS	210
ZE08.410HS	HS	410
ZE08.430HS	HS	430
ZE08.510HS	HS	510
ZE08.600HS	HS	600
ZE08.630HS	HS	630
ZE08.050HW	HW	50
ZE08.100HW	HW	100
ZE08.130HW	HW	130
ZE08.180HW	HW	180
ZE08.210HW	HW	210
ZE08.410HW	HW	410
ZE08.430HW	HW	430
ZE08.510HW	HW	510
ZE08.600HW	HW	600
ZE08.630HW	HW	630

Other dimensions available on request

TURNBLADES "BRÜCK"

ART. ZE 09

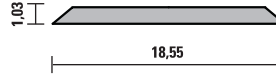

12 pcs. packaging

- Antioxidant treatment on knife body
- Polished cutting face for an excellent finish quality
- HS 18% for medium hard wood
- HSCo (cobalt) for very hard wood and abrasive materials

Item	Quality	L
ZE09.060HS	HS	60
ZE09.100HS	HS	100
ZE09.130HS	HS	130
ZE09.180HS	HS	180
ZE09.210HS	HS	210
ZE09.250HS	HS	250
ZE09.310HS	HS	310
ZE09.400HS	HS	400
ZE09.450HS	HS	450
ZE09.510HS	HS	510
ZE09.630HS	HS	630
ZE09.810HS	HS	810
ZE09.060HSCO	HSCo	60
ZE09.100HSCO	HSCo	100
ZE09.130HSCO	HSCo	130
ZE09.180HSCO	HSCo	180
ZE09.210HSCO	HSCo	210
ZE09.250HSCO	HSCo	250
ZE09.310HSCO	HSCo	310
ZE09.400HSCO	HSCo	400
ZE09.450HSCO	HSCo	450
ZE09.510HSCO	HSCo	510
ZE09.630HSCO	HSCo	630
ZE09.810HSCO	HSCo	810

Other dimensions available on request

UNIVERSAL TURNBLADES "ESTA"

ART. ZE10

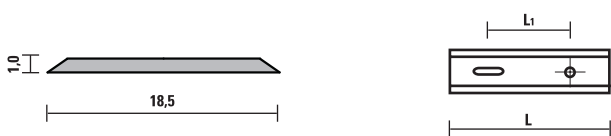

- Antioxidant treatment on knife body
- Polished cutting face for an excellent finish quality
- HS 18% for medium hard wood
- From L= 60 to L= 280 mm (20 pcs packaging)
- From L= 300 to L= 810 mm (12 pcs packaging)

Item	Quality	L	L1	holes	slots	
ZE10.060HS	HS	60	45	1	1	
ZE10.100HS	HS	100	45	1	1	
ZE10.130HS	HS	130	45	1	2	
ZE10.200HS	HS	200	45	1	2	
ZE10.300HS	HS	300	100	1	2	Also for machines: Holz-her, Hema, Protool
ZE10.400HS	HS	400	100	2	3	
ZE10.410HS	HS	410	100	2	3	
ZE10.430HS	HS	430	100	2	3	
ZE10.500HS	HS	500	100	1	4	
ZE10.520HS	HS	520	100	1	4	
ZE10.530HS	HS	530	100	1	4	
ZE10.630HS	HS	630	200	1	3	
ZE10.650HS	HS	650	200	1	3	
ZE10.810HS	HS	810	200	1	3	

Other dimensions available on request

SPECIAL TURNBLADES "ESTA"

ART. ZE11

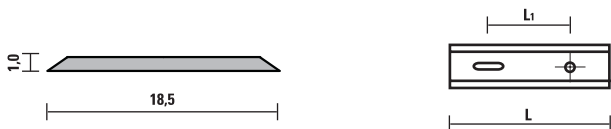

- Antioxidant treatment on knife body
- Polished cutting face for an excellent finish quality
- HS 18% for medium hard wood
- From L= 60 to L= 280 mm (20 pcs packaging)
- From L= 300 to L= 810 mm (12 pcs packaging)

Item	Quality	L	L1	holes	slots	Machine	
ZE11.248HS	HS	248	130	1	1	Mafell	
ZE11.280HS	HS	280	130	1	1	Mafell	
ZE11.310HS	HS	310	70	1	3	Felder	
ZE11.311HS	HS	310	65-60-60-65	1	4	Hammer	
ZE11.320HS	HS	320	105	1	2	Mafell	
ZE11.350HS	HS	350	65-100-100-65	1	4	Holz-her Hema Protool	
ZE11.410HS	HS	410	70	1	5	Hammer	
ZE11.411HS	HS	410	100	1	4	Felder	
ZE11.510HS	HS	510	120	1	4	Felder	

Other dimensions available on request

SAWBLADES



HW SAWBLADES FOR PORTABLE MACHINES
Pag. 12.18



HW SAWBLADES FOR PORTABLE MACHINES
Pag. 12.20



HW SAWBLADES FOR PORTABLE MACHINES
Pag. 12.20



EXTRA THIN PROFESSIONAL SAWBLADES
Pag. 12.21



EXTRA THIN PROFESSIONAL SAWBLADES
Pag. 12.22



EXTRA THIN PROFESSIONAL SAWBLADES
Pag. 12.22



HW GROOVING CUTTER FOR "LAMELLO"
Pag. 12.23



HW GROOVING CUTTER FOR "LAMELLO"
Pag. 12.23



DP GROOVE CUTTER FOR "LAMELLO"
Pag. 12.23



DP GROOVE CUTTER FOR "LAMELLO"
CLAMEX P
Pag. 12.24



DP SAWBLADES FOR CUTTING ABRASIVE MATERIALS
Pag. 12.24



HW GROOVING SAWBLADES
Pag. 12.25





HW RADIAL ARM SAWBLADES
Pag. 12.26



HW MULTI PURPOSE
CIRCULAR SAWBLADES
Pag. 12.26



HW CIRCULAR SAWBLADES FOR RIPPING
AND CROSSCUTTING (MULTI PURPOSE)
Pag. 12.27

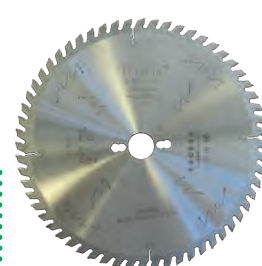

HW MULTI PURPOSE
CIRCULAR SAWBLADES
Pag. 12.27



HW TRIMMING FINISHING
Pag. 12.28



HW TRIMMING FINISHING
Pag. 12.28



HW TRIMMING AND FINE FINISHING
Pag. 12.29

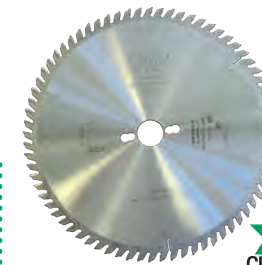

HW TRIMMING AND FINE FINISHING
Pag. 12.29



HW TRIMMING FINISHING
SAW BLADES FOR HSK-63 ADAPTERS
Pag. 12.30



HW TRIMMING FINISHING
SAW BLADES FOR HSK-63 ADAPTERS
Pag. 12.30



HW MULTI PURPOSE SAWBLADES
(THIN KERF)
Pag. 12.31



HW MULTI PURPOSE SAWBLADES
(THIN KERF)
Pag. 12.31



HW MULTI PURPOSE SAWBLADES
(THIN KERF)
Pag. 12.32



HW THICK KERF SAWBLADES
Pag. 12.33



HW MULTI PURPOSE CIRCULAR
SAWBLADES
Pag. 12.33



HW INDUSTRIAL RIPPING
SAWBLADES
Pag. 12.34



HW SAWBLADES FOR
BUOLDING SITES
Pag. 12.34



HW SAWBLADES FOR
CUTTING BEAMS
Pag. 12.35



HW FINE FINISHING SAWBLADES
Pag. 12.35



HW EXTRA FINE
FINISHING SAWBLADES
Pag. 12.36





HW TRIMMING AND SIZING SAWBLADES
Pag. 12.36



HW SAWBLADES FOR BILAMINATED PANELS
Pag. 12.37



HW SAWBLADES FOR BILAMINATED PANELS
Pag. 12.37



DP SAWBLADES FOR BILAMINATED PANELS
Pag. 12.38



HW SAWBLADES FOR "SANDWICH" PANELS
Pag. 12.38



HW MULTIRIP SAWBLADES WITHOUT RAKERS
Pag. 12.39



HW SHOULDER RIP SAWBLADES WITH RAKERS
Pag. 12.39



HW MULTIRIP SAWBLADES WITH RAKERS
Pag. 12.40



HW MULTIRIP SAWBLADES WITH RAKERS (THIN KERF)
Pag. 12.41



HW CONICAL SCORING SAWBLADES
Pag. 12.46



DP CONICAL SCORING SAWBLADES
Pag. 12.47



HW ADJUSTABLE SCORING SAWBLADES
Pag. 12.48



DP ADJUSTABLE SCORING SAWBLADES
Pag. 12.48



HW PANEL SIZING SAWBLADES
Pag. 12.49



HW PANEL SIZING SAWBLADES
Pag. 12.50



DP PANEL SIZING SAWBLADES
Pag. 12.52



HW SCORING SAWBLADES FOR EDGE BANDING AND SQUARING MACHINES
Pag. 12.53



HW SCORING SAWBLADES FOR EDGE BANDING AND SQUARING MACHINES
Pag. 12.53



HW SAWBLADES FOR CNC MACHINING CENTRES
Pag. 12.54



HW SAWBLADES FOR OPTIMIZING CROSSCUT SAW MACHINE
Pag. 12.54



Xtra
cut

HW POSITIVE SAWBLADES
FOR ALUMINIUM
Pag. 12.55



Xtra
cut

HW NEGATIVE SAWBLADES
FOR ALUMINIUM
Pag. 12.56



Xtra
cut

HW SAWBLADES FOR PVC
Pag. 12.57



HW SAWBLADES FOR PVC
AND PLEXIGLASS
Pag. 12.57



HW SAWBLADES FOR "SOLID SURFACE"
AND CHIPBOARD PANEL
Pag. 12.58



REDUCTION RINGS FOR SAWBLADES
Pag. 12.58



HW "DRY" OR "QUATTRO"
SAWBLADES
Pag. 12.59



HW DMo5 SAWBLADES
FOR FERROUS MATERIALS
Pag. 12.60

INDUSTRIAL CIRCULAR SAWBLADES

Klein sawblades are high quality products, guaranteed by the choice of best raw materials developed in collaboration with leading European manufacturers of steel and carbide. Throughout the production cycle, controls are followed extremely scrupulous and final acceptance ensures that all the characteristics of the saw blades are meeting the highest level of quality standards.



LASER CUT EXPANSION SLOTS allow heat dispersion and improve blade stability.

LASER CUT STEEL BLADE with German steel to provide great tolerances and stability.

MICROGRAIN INDUSTRIAL CARBIDE TIPS made by Ceratizit to provide sharper edge and longer cutting life.

TENSIONING RING AND BALANCING to guarantee highest cutting performance, concentricity and flatness of the blade





TRI-METAL BRAZING OPERATION (alloy+copper+alloy) for best performance and maximum resistance to stress

LASER CUT ANTI-VIBRATION SLOTS especially designed to improve finishing and reduce noise

LOW NOISE SAWBLADES

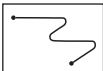
According to the latest technical tests, all the **Klein** industrial sawblades are manufactured with an advanced system of noise reduction guaranteed by a scrupulous position of the laser slots, different for each diameter. The body of the sawblades remains solid and perfectly tensioned while sound waves generated during cutting are absorbed both longitudinally and crosswise.

The **Xtra cut** sawblades have a special sound absorbing plastic resin filled inside the silent slots that helps to reduce dramatically vibration and noise during cutting. This innovative technology allows the blade to work with less effort, thus ensuring a better finish and longer blade lifetime, even after regrinding.

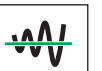
INDUSTRIAL SAWBLADES		Xtra cut SAWBLADES	
SILENT SLOT	NO NOISE	SILENT SLOT WITH RESIN	NO NOISE NO VIBRATION
			 
SILENT SLOT	NO NOISE	SILENT SLOT WITH RESIN	NO NOISE NO VIBRATION

WATCH VIDEO



LASER CUTTING

The **Klein** sawblades are exclusively worked with laser cutting. **Bores and keyways are honed to ensure maximum precision (h7)**. Without this process there will be a visible slot on the bore edge.

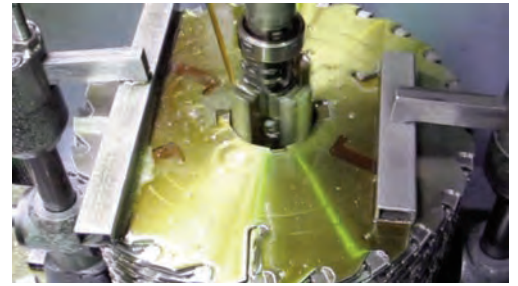
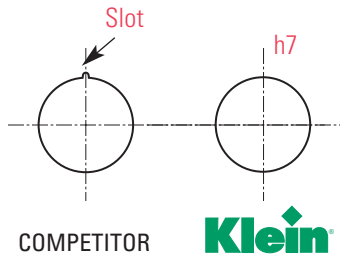

TENSIONING AND BALANCING

Are operated with completely automatic machines, which assure **the absence of vibrations and higher quality results**. The visible ring on the body of the saw blades guarantees maximum cutting performance, concentricity and flatness tolerance of the blade.

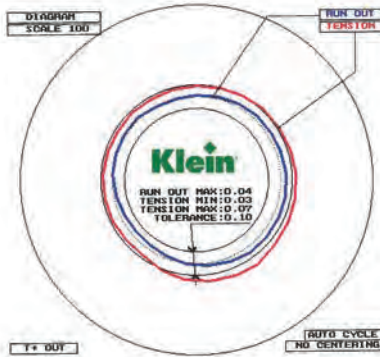

MICROGRAIN INDUSTRIAL CARBIDE TIPS

SISTEMI uses only Ceratizit micrograin carbide tips, which offer competitive advantages due to innovative and sophisticated carbide grades and a variety of geometries available for industrial applications on any material. They are characterized by excellent wear resistance and toughness, ensuring outstanding precision and maximum lifetime, with an increase in lifetime of up to 30%.

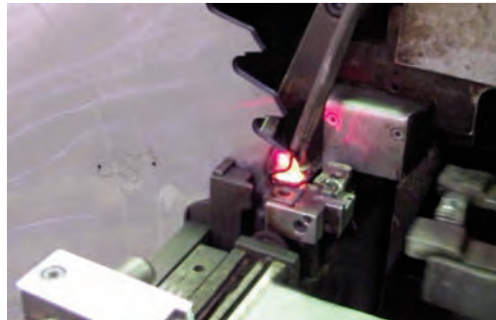

Xtra[®] cut

THE NEXT GENERATION OF INDUSTRIAL SAWBLADES

SISTEMI introduces the new **Klein Xtra[®] cut** blades to take the cutting experience to the **next level and increase productivity**. The manufacturing process is entirely laser-machined to ensure maximum precision. Tensioning and balancing are managed for maximum performance; in fact, the superior blade flatness extends blade life and delivers exceptional finishing results.

In addition, the silent slots are made with a distinct geometry and are filled with a special synthetic resin to avoid vibration, reduce noise and increase stability.

**NO NOISE
NO VIBRATION**



Carbide tips with original Ceratizit micrograin last longer with a sharp edge, providing up to 30 percent longer life. **Klein Xtra[®] cut** is the best solution for every need, ideal for cutting **veneers and laminates, plywood, MDF, particle board and plastic laminates, PVC, aluminum, plastic and Alucobond**, ensuring a better finish and longer life for the best performance.



WATCH THE DEMO



USEFUL INFORMATION

QUALITY OF TUNGSTEN CARBIDE USED:

Quality	Composition	Grain size	Bending strength	Hardness	Density	Toughness	Wear resistance
KCR05+ ISO: K01 USA: C4	Co+Ni 2,76%	Ultrafine grain 0,2-2,0,5 µm	2900 MPa	2160 HV10 94,5 HRA	15,20 g/cm ³	7,8 MPa.m ^{-1/2}	0 1 2 3 4 5 6 7 8 9 10
KCR10 ISO: K10 USA: C3	Co 5,6%	Fine grain 0,8-2,1,3 µm	2800 MPa	1780 HV10 92,8 HRA	15,00 g/cm ³	10,1 MPa.m ^{-1/2}	0 1 2 3 4 5 6 7 8 9 10
SMX ISO: P20-P25 USA: C6	Co 10,5%	Fine grain 0,8-2,1,3 µm	2200 MPa	1550 HV10 91,5 HRA	12,65 g/cm ³	10,0 MPa.m ^{-1/2}	0 1 2 3 4 5 6 7 8 9 10

Technical data and images are just an indication. **SISTEMI** srl reserves the right to modify the above information at any time and without notice.

DIAGRAM FOR DETERMINING THE PERIPHERAL CUTTING SPEED:

Diagram shows the peripheral cutting speed in m/sec, defined RPM and sawblades diameter.

V_t = cutting speed (m/sec)
D = sawblades diameter (mm)
n = RPM

$$V_t = \frac{D \times \pi \times n}{60 \times 1.000}$$

RPM \ D=mm	1500	2000	2500	2800	3000	3500	4000	4500	5000	5600	6000	8000	9000	10000	12000	18000
80	6,5	8,5	10,5	12	13	14	15	19,1	21	23,5	26	34	38	42	52	76
90	7	9,5	12	13,5	14	16	17	21	24	26,5	28	38	42	48	56	84
100	8	10	13	15	16	18	21	24	26	29	31	41	47	52	63	96
120	9,5	13	16	18	19	22	25	28	31	35	38	49	57	63	65	
125	10	14	16,5	20	19,5	24	27	31	34	36,5	41	53	61	68	82	
140	11	15	18	21	22	26	29	33	37	41	44	57	66	73	88	
150	12	16	19,5	22	23,5	27	31	35	39	44	47	63	71	79	94	
160	13	17	21	24	26	29	33	38	42	47	50	65	75	84		
180	14	19	24	27	28	33	42	42	47	53	57	73	85	94		
200	16	21	26	29	32	37	42	47	52	58,5	63	81	94			
225	17	23	30	32	36	40	46	52	58	66	69	92	104			
250	20	26	33	37	40	46	52	59	65	73,5	79					
300	24	31	40	44	48	55	63	71	79	88	94					
350	27	37	47	51	56	64	73	83	92	105						
400	31	42	54	59	64	73	83	92	105							
450	35	47	59	66	70,5	83	94	105								
500	39	52	67	73	80	92										

- Mineral fibreplates
- Wood-based material, plastic material and non-ferrous metal
- Hardwood
- Softwood
- Safety limit

RECOMMENDED PERIPHERAL CUTTING SPEED:

CUTTING MATERIAL	Peripheral cutting speed (m/s)	Feed rate (mm/z)
Softwood	Cutting along grain	0,5÷3,0
	Cutting across grain	0,2÷0,4
Hardwood	Cutting along grain	0,3÷1,0
	Cutting across grain	0,2÷0,8
Exotic timber	Cutting along grain	0,3÷1,0
Plywood		0,1÷0,2
Particle board		0,3
HDF		0,1÷0,3
MDF		0,1÷0,3
Playwood boards, veneered or coated on both sides		0,2
Laminated boards		0,1-0,25
Melamine		0,15
Thermoplastic		0,05-0,1
Duroplastic		0,02-0,05
Aluminium profiles		0,005-0,08

Reference table for the choice of the right sawblade (X= sufficient - XX= good - XXX= excellent) Information just as a guide

Item	Natural woods						Pressed woods		Board materials			Multi materials (FIBERCEMENT) ETERNIT...
	SOFTWOOD (cider, poplar, pine)		HARDWOOD (ash, walnut, teak)		EXOTIC TIMBER		PLYWOOD	PARTICLE BOARD	BLOCK BOARD	VENEERED	LAMINATED	
	Rip cut	Cross cut	Rip cut	Cross cut	Rip cut	Cross cut						
Art. AA - Page 12.18	XXX	XXX	XXX	XXX	XX	XX	XX	X	XX	XX	X	
Art. AB - Page 12.20	X	X	X	X	X	X	XX	X	X	X	XX	
Art. AL - Page 12.20									X	X	XX	
Art. AP - Page 12.21	XXX	X	XXX	X	XX		XXX	XX	XX	XX	X	
Art. AR - Page 12.22	XX	X	XX	X	X		XX	XX	XX	XX	XXX	
Art. AT - Page 12.22									X	X	XX	
Art. AH/XAH - Page 12.23	XXX	XX	XXX	XXX	X	XXX	XX	XXX	XXX	XX	XX	
Art. XGE - Page 12.24												XXX
Art. KA - Page 12.25	XXX	XXX	XXX	XX	XXX	XX	XX				X	
Art. FAS - Page 12.26		XX		XX		X	XX			X	X	
Art. CA - Page 12.26	X	XX	X	XX	X	X	XX	XXX	X			
Art. CB/CBS - Page 12.27	XXX	XX	XXX	XX	XX	XX	X	XXX	XX	XX	X	
Art. CCS - Page 12.27	XX	XX	XXX	XXX	X	XX	XX	XXX	XX	XX	X	
Art. CD / CDS / CDT / CP Pages 12.28 - 12.33	XXX	XX	XXX	XXX	X	XXX	XX	XXX	XXX	XX	XX	
Art. CE / CES / CET Page 12.29	X	XX	XXX	XXX	XXX	XXX	XXX	XXX	X	XX	XX	
Art. CF - Page 12.31	X	X	X	XX	XX	XX			X	XX	XXX	
Art. CG - Page 12.31	XX	XXX	XX	XXX	XX	XXX	XXX	XXX	X	XX	XX	
Art. CH - Page 12.32	XX	XXX	XX	XXX	XX	XXX	XXX	XXX	X	XX	XX	
Art. DA - Page 12.33	XXX	X	XXX	X			X	X				
Art. DC - Page 12.34	XXX	XX	XXX	XX	XXX	X	XX	X	XX	XX	XX	
Art. GA - Page 12.34	XXX	XX	XXX	XX	X	X	XX					X
Art. DL - Page 12.35	XXX	XXX	XXX	XXX	XX	XX	XX	XX	XX	XX	XX	
Art. MLS/MMS - Page 12.35	XXX	XXX	XXX	XXX	XX	XX	XX	XX	X	XX	XX	
Art. FB - Page 12.36	X	X	X	X	X	X	XXX	XX	XX	XXX	XXX	
Art. FCS / FCT / XFC Page 12.37	X	XX	X	XX	X	XX	XX	XXX	XXX	XXX	XXX	
Art. MP - Page 12.38							XX	XX	XX	XX	XX	
Art. FE / FG / FH / FK Page 12.39	XXX	XX	XXX	XX	XX	XX	X	X				
Art. FI / XFI / FL / XFL Page 12.46							XX	XXX	XXX	XXX	XXX	
Art. HBS - Page 12.49							X	XX	XX	XX	XX	
Art. HCS / XHC / FR Pages 12.50 - 12.54							XXX	XXX	XXX	XXX	XXX	
Art. FM / FP - Page 12.53							XX	XXX	XXX	XXX	XXX	
Art. MRS - Page 12.54	XX	XXX	XX	XXX	X	X	X	X				
Art. LA - Page 12.55												
Art. LB - Page 12.56												
Art. LE - Page 12.37												
Art. MES - Page 12.58	X	X	X	X			XX	X			X	
Art. MGS - Page 12.57							XX	X			X	
Art. LZ - Page 12.59	X	X	XX	XX	X	X	X	X				XX
Art. PA - Page 12.60												
Art. PB - Page 12.60												

Reference table for the choice of the right sawblade (X= sufficient - XX= good - XXX= excellent) Information just as a guide











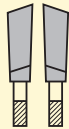

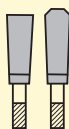

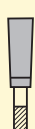

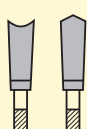

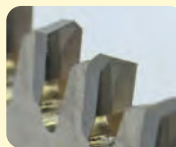
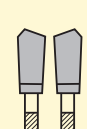

Item	Panels			Plastic materials			Sandwich	Non-ferrous materials			Ferrous materials	
	FIBER		PLASTIC COATED	THERMOPLASTIC	DUROPLASTICS PVC	WITH PLASTIC BINDERS		ALUMINIUM PROFILES	ALLUMINIUM	BRASS COPPER	PROFILES	SOLID
	HDF	MDF										
Art. AA - Page 12.18												
Art. AB - Page 12.20				XX	XX	XX		XX	XX	XX		
Art. AL - Page 12.20		XX		XX	XX	XX		XXX	XX	XX		
Art. AP - Page 12.21	X	XX										
Art. AR - Page 12.22	X	XX	X	X								
Art. AT - Page 12.22	X	X	X	X	X			XXX	XX	XX		
Art. AH/XAH - Page 12.23	X	X										
Art. XGE - Page 12.24				XX	XX	XX	XX	X	X	X		
Art. KA - Page 12.25		X	X									
Art. FAS - Page 12.26			XXX			X						
Art. CA - Page 12.26		X										
Art. CB/CBS - Page 12.27	X	X										
Art. CCS - Page 12.27	X	X										
Art. CD / CDS / CDT / CP Pages 12.28 - 12.33	X	X										
Art. CE / CES / CET Page 12.29	XX	XX		XXX	XX	X						
Art. CF - Page 12.31		XX										
Art. CG - Page 12.31	X	XX	X	XX	XX	XX						
Art. CH - Page 12.32				XXX	XX	XX						
Art. DA - Page 12.33												
Art. DC - Page 12.34		X		X								
Art. GA - Page 12.34												
Art. DL - Page 12.35	X	X	X									
Art. MLS/MMS - Page 12.35	XX	XXX	XX							XX		
Art. FB - Page 12.36	XX	XX	XXX	XXX	XXX	X						
Art. FCS / FCT / XFC Page 12.37	XX	XXX	XX	XX	XX	X	X					
Art. MP - Page 12.38	X	X					XXX					
Art. FE / FG / FH / FK Page 12.39												
Art. FI / XFI / FL / XFL Page 12.46	XXX	XXX	XXX									
Art. HBS - Page 12.49	XX	XX	X									
Art. HCS / XHC / FR Pages 12.50 - 12.54	XXX	XXX	XXX	X	XXX	X						
Art. FM / FP - Page 12.53	XXX	XXX	XXX									
Art. MRS - Page 12.54				X	XXX	XX						
Art. LA - Page 12.55				X	XX	X		XXX	XX	X		
Art. LB - Page 12.56				X	XX	X		XX	XXX	X		
Art. LE - Page 12.37				XX	XXX	XXX		X	X	X		
Art. MES - Page 12.58	X	X	XX	X	XXX	XX						
Art. MGS - Page 12.57			X	XXX	XXX	X						
Art. LZ - Page 12.59				X	X	X		XX	XX	XX	XXX	
Art. PA - Page 12.60											XXX	XXX
Art. PB - Page 12.60											XXX	XXX

NUMBER OF TEETH SUGGESTED:

Calculation of the number of teeth, given the diameter of the saw blade and the thickness of the material to be worked.

$$Z \text{ (nr. teet)} = \frac{D \text{ (diameter/mm)} \times K}{Sp \text{ (thickness/mm)}}$$

K = 7 for ripcutting on natural wood
K = 9 for ripping or crosscutting
K = 11 for crosscutting of hard woods and hard materials

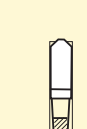
  <p>WZ (ATB): alternate top bevel teeth, suitable for soft and hardwood, fibre materials, MDF. Especially clean cuts.</p>	  <p>FZ/TR (TCG): triple chip teeth form, suitable for solid wood, plastic coated materials, non ferrous profiles, hardwood.</p>	  <p>FZ: flat teeth, suitable for cutting along grain on large cutting height soft and hardwood.</p>	  <p>HZ/DZ: Hollow tooth/inverted V-tooth, suitable for saw benches on plastic coated chipboards and fibre materials.</p>
  <p>FZ/FA: Flat tooth with bevel, with chip limiter, for cutting timber, also in presence of concrete or metal remains, nails, etc.</p>	  <p>LFZ: flat teeth with chip limiter, suitable for tablesaws. For cutting along and across grain in wooden boarding materials.</p>	  <p>KON/FZ: conical tooth, used on scoring blades</p>	  <p>WZ/FA: alternate top bevel teeth, suitable for soft and hardwood, fibre materials, MDF. Especially clean cuts.</p>
  <p>TR: trapezoidal tooth, used on saw blades "dry" (Item LZ).</p>	  <p>ES: (ES-L/ES-R) One-sided top bevel tooth (right or left), used on edge banding machines or hogging units.</p>	  <p>BW: special tooth shape for item "PB" (steel blade, for cutting metals).</p>	  <p>C: special tooth shape for item "PA" (steel blade, for cutting metals).</p>

Klein saw blades for portable machines are delivered in hanging packaging while those for industrial machines in a very robust carton packaging.

PACKAGING SAW BLADES FOR PORTABLE MACHINES



Sawblades	Dimensions
Ø127÷Ø140	165x179x5
Ø150÷Ø190	215x234x5
Ø200÷Ø240	254x277x5

Klein extra thin professional sawblade.



Sawblades	Dimensions	Sawblades	Dimensions
Ø85	100x140	Ø210/216	232x252
Ø136	159x184	Ø250	258/270
Ø160/165	184x208	Ø305	322x352
Ø190	208x233		

All **Klein** packagings are marked with the symbol  meaning 100% recyclable carton, vegetable oil-based inks and glues.

PACKAGING SAW BLADES FOR INDUSTRIAL MACHINES

Our saw blades are high quality products, which have been produced choosing the finest raw material and guaranteed by special and scrupulous controls during the production cycle. The final acceptance ensures that all the characteristics of the saw blades Klein® are meeting the highest standard of quality. When you work with a Klein® saw blade, you choose a reliable tool, which can give you a better finish and a higher precision compared to other brand.



Sawblades	Dimensions
Ø80÷Ø150	210x210x15
Ø160÷Ø210	255x255x15
Ø220÷Ø250	300x300x15
Ø280÷Ø300	355x355x15
Ø320÷Ø350	400x400x15
Ø355÷Ø400	455x455x15
Ø420÷Ø500	550x550x15
Ø520÷Ø600	655x655x15
Ø620÷Ø700	725x725x20

**Multilingual
inside sheet**

HOW TO READ THE CATALOGUE

HW EXTRA FINE FINISHING SAWBLADES

ART. MMS

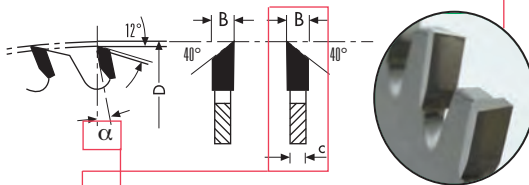
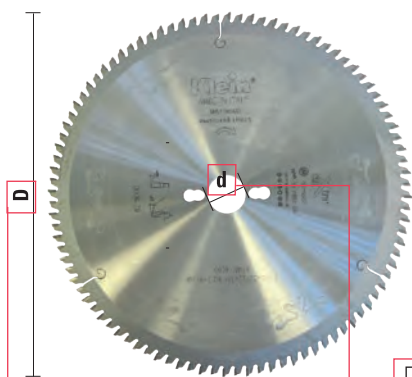

SILENT SLOT
WITH RESIN

NO NOISE

NO VIBRATION

Item	D	d	B/c	Z	α	Pin holes
MMS250.08030	250	30	3,2/2,2	80	-2°	PH02
MMS300.09630	300	30	3,0/2,5	96	5°	PH02
MMS350.10830	350	30	3,5/2,5	108	5°	PH02

TEETH FEATURES

- WZ (ATB) alternate top bevel teeth
- HW grade: KCR05+ (K01-C4)

MATERIALS

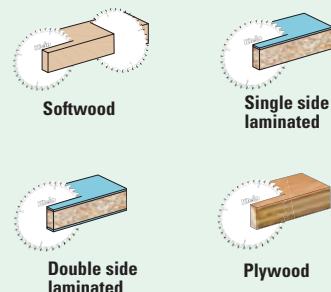

MACHINES



USEFUL INFORMATION

- Ideal for cutting frames
- Excellent finish on 45° cut
- Pin holes: PH02=2/7/42 + 2/9,5/46,5 + 2/10/60

GUIDE TO PIN HOLES

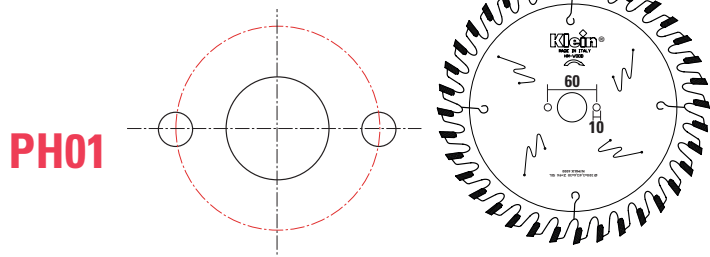

Name	Nr of holes/diameter of holes/pitch circle diameter	Machine type
PH01	2/10/60	Universal

Number of pin holes | Centre to centre distance
Pin holes diameter

D	d	B/c	Z	α	Teeth	Quality	Item No.	Materials	Page	D	d	B/c	Z	α	Teeth	Quality	Item No.	Materials	Page
80	20	3,1-4,0/2,2	12	10°	KON	HW	FI080.01220	WOOD	12.46	125	30	10,0/6,0	12	14°	FLAT	HW	KA125.0123099	WOOD	12.25
80	20	2,8-3,6/2,2	10+10	10°	FLAT	HW	FL080.01020	WOOD	12.48	125	30	3,4-4,5/2,2	24	10°	KON	HW	FI127.02430	WOOD	12.46
85	15	0,9/1,3	20	12°	WZ (ATB)	HW	AP085.02015	WOOD	12.21	125	30	4,0/3,0	24	10°	WZ (ATB)	HW	FR126.02430	WOOD	12.54
85	15	1,3/0,9	20	12°	WZ (ATB)	HW	AP085.02015	WOOD	12.21	125	30	3,2/2,2	36	5°	WZ (ATB)	HW	FR125.03630	WOOD	12.54
100	20	3,2/2,2	20	10°	WZ (ATB)	HW	CB100.02020	WOOD	12.27	125	45	3,1-4,3/2,2	24	10°	KON	HW	FI125.02445	WOOD	12.46
100	20	3,1-4,3/2,2	20	10°	KON	HW	FI100.02020	WOOD	12.46	125	45	4,3-5,5/3,2	24	10°	KON	HW	FI126.02445	WOOD	12.46
100	20	3,2/2,2	20	15°	WZ (ATB)	HW	FM100.02020	WOOD	12.53	130	16	2,6/1,6	20	15°	WZ (ATB)	HW	AA130.02016	WOOD	12.18/19
100	20	3,2/2,2	20	10°	ES	HW	FP100.02020L	WOOD	12.53	130	16	2,6/1,6	36	15°	WZ (ATB)	HW	AA130.03616	WOOD	12.18/19
100	20	3,2/2,2	20	10°	ES	HW	FP100.02020R	WOOD	12.53	134	20	2,6/1,6	36	15°	WZ (ATB)	HW	AA134.03620	WOOD	12.18/19
100	20	2,8-3,6/2,2	10+10	10°	FLAT	HW	FL100.01220	WOOD	12.48	136	20	1,5/1,0	24	20°	WZ (ATB)	HW	AP135.02420	WOOD	12.21
100	22	3,96/2,8	3		WZ (ATB)	PCD	XAH100.20622	WOOD	12.23/24	136	20	1,5/1,0	24	20°	WZ (ATB)	HW	AP135.02420	WOOD	12.21
100	22	3,96/2,8	6	15°	WZ (ATB)	HW	AH100.20622	WOOD	12.23	140	12,7	2,6/1,6	20	15°	WZ (ATB)	HW	AA140.02013	WOOD	12.18/19
100	22	3,96/2,8	8	15°	WZ (ATB)	HW	AH100.10622	WOOD	12.23	140	12,7	2,6/1,6	42	15°	WZ (ATB)	HW	AA140.04213	WOOD	12.18/19
100	22	3,96/2,8	12	15°	WZ (ATB)	HW	AH100.21222	WOOD	12.23	140	16	2,6/1,6	20	15°	WZ (ATB)	HW	AA140.02016	WOOD	12.18/19
100	22	3,1-4,3/2,2	20	10°	KON	HW	FI100.02022	WOOD	12.46	140	16	2,6/1,6	42	15°	WZ (ATB)	HW	AA140.04216	WOOD	12.18/19
100	22	2,8-3,6/2,2	10+10	10°	FLAT	HW	FL100.01222	WOOD	12.48	140	20	2,6/1,6	20	15°	WZ (ATB)	HW	AA140.02020	WOOD	12.18/19
100,4	22	7	3		P-System	PCD	XAH100.10322	WOOD	12.23/24	140	20	2,6/1,6	30	15°	WZ (ATB)	HW	AA140.03020	WOOD	12.18/19
100,4	30	7	3		P-System	PCD	XAH100.10330	WOOD	12.23/24	140	20	2,6/1,6	42	15°	WZ (ATB)	HW	AA140.04220	WOOD	12.18/19
100,4	30	7	6		P-System	PCD	XAH100.10630	WOOD	12.23/24	140	30	3,6/2,4	36	5°	WZ (ATB)	HW	FR140.03630	WOOD	12.54
110	20	3,1-4,3/2,2	20	10°	KON	HW	FI110.02020	WOOD	12.46	150	16	2,6/1,6	24	15°	WZ (ATB)	HW	AA150.02016	WOOD	12.18/19
115	30	2,6/1,8	24	15°	WZ (ATB)	HW	FM115.02430	WOOD	12.53	150	16	2,6/1,6	40	15°	WZ (ATB)	HW	AA150.03016	WOOD	12.18/19
115	30	2,6/1,8	24	10°	ES	HW	FP115.02430L	WOOD	12.53	150	20	2,6/1,6	24	15°	WZ (ATB)	HW	AA150.02020	WOOD	12.18/19
115	30	2,6/1,8	24	10°	ES	HW	FP115.02430R	WOOD	12.53	150	20	2,2/1,6	30	0°	TR	HW	LZ150.03020	MULTI-MATERIALS	12.59
120	20	3,2/2,2	20	10°	WZ (ATB)	HW	CB120.02020	WOOD	12.27	150	20	2,6/1,6	40	15°	WZ (ATB)	HW	AA150.03020	WOOD	12.18/19
120	20	3,1-4,3/2,2	20	10°	KON	HW	FI120.02420	WOOD	12.46	150	20	2,6/1,6	48	15°	WZ (ATB)	HW	AA150.04820	WOOD	12.18/19
120	20	3,4-4,5/2,2	20	10°	KON	HW	FI122.02020	WOOD	12.46	150	30	1,5/1,1	18	14°	FLAT	HW	KA150.0183015	WOOD	12.25
120	20	3,1-3,7/2,2	20	10°	KON/FZ	PCD	XFI120.02020	WOOD	12.47	150	30	1,8/1,3	18	14°	FLAT	HW	KA150.0183018	WOOD	12.25
120	20	3,2/2,2	30	15°	WZ (ATB)	HW	FM120.03020	WOOD	12.53	150	30	2,0/1,4	18	14°	FLAT	HW	KA150.0183020	WOOD	12.25
120	20	2,8-3,6/2,2	12+12	10°	FLAT	HW	FL120.01220	WOOD	12.48	150	30	2,5/1,6	18	14°	FLAT	HW	KA150.0183025	WOOD	12.25
120	22	3,1-4,3/2,2	20	10°	KON	HW	FI120.02422	WOOD	12.46	150	30	3,0/2,0	18	14°	FLAT	HW	KA150.0183030	WOOD	12.25
120	22	3,1-3,7/2,2	20	10°	KON/FZ	PCD	XFI120.02022	WOOD	12.47	150	30	3,5/2,5	18	14°	FLAT	HW	KA150.0183035	WOOD	12.25
120	22	2,8-3,6/2,2	12+12	10°	FLAT	HW	FL120.01222	WOOD	12.48	150	30	4,0/2,8	18	14°	FLAT	HW	KA150.0183040	WOOD	12.25
120	35	4,0/2,8	30		FLAT	HW	FR120.03035	WOOD	12.54	150	30	5,0/4,0	18	14°	FLAT	HW	KA150.0183050	WOOD	12.25
120	45	4,3-5,5/2,8	24	10°	KON	HW	FI121.02445	WOOD	12.46	150	30	6,0/4,0	18	14°	FLAT	HW	KA150.0183060	WOOD	12.25
120	50	2,8-3,8/2,2	12+12	10°	FLAT	HW	FL120.01250AN	WOOD	12.48	150	30	7,0/6,0	18	14°	FLAT	HW	KA150.0183070	WOOD	12.25
125	12,7	2,6/1,6	36	15°	WZ (ATB)	HW	AA127.03613	WOOD	12.18/19	150	30	8,0/6,0	18	14°	FLAT	HW	KA150.0183080	WOOD	12.25
125	20	3,2/2,2	20	15°	WZ (ATB)	HW	FM125.02020	WOOD	12.53	150	30	9,0/6,0	18	14°	FLAT	HW	KA150.0183090	WOOD	12.25
125	20	3,1-3,7/2,2	20	10°	KON/FZ	PCD	XFI125.02420	WOOD	12.47	150	30	10,0/6,0	18	14°	FLAT	HW	KA150.0183099	WOOD	12.25
125	20	3,1-4,3/2,2	24	10°	KON	HW	FI125.02420	WOOD	12.46	150	30	2,6/1,6	24	15°	WZ (ATB)	HW	AA150.02030	WOOD	12.18/19
125	20	4,3-5,5/3,2	24	10°	KON	HW	FI126.02420	WOOD	12.46	150	30	3,2/2,2	24	10°	WZ (ATB)	HW	CB150.02430	WOOD	12.27
125	20	3,4-4,5/2,2	24	10°	KON	HW	FI127.02420	WOOD	12.46	150	30	2,2/1,6	24	10°	WZ (ATB)	HW	CF150.02430	WOOD	12.31
125	20	3,2/2,2	30	10°	ES	HW	FP125.03020L	WOOD	12.53	150	30	4,3-5,5/3,2	24	10°	KON	HW	FI151.02430	WOOD	12.46
125	20	3,2/2,2	30	10°	ES	HW	FP125.03020R	WOOD	12.53	150	30	3,2/2,2	36	10°	WZ (ATB)	HW	CD150.03630	WOOD	12.28
125	20	2,8-3,4/2,2	10+10	10°	FLAT	PCD	XFL125.01020	WOOD	12.48	150	30	3,4-4,5/2,2	36	10°	KON	HW	FI150.03630	WOOD	12.46
125	20	2,8-3,6/2,2	12+12	10°	FLAT	HW	FL125.01220	WOOD	12.48	150	30	4,3-5,5/3,2	36	10°	KON	HW	FI151.03630	WOOD	12.46
125	22	3,1-3,7/2,2	20	10°	KON/FZ	PCD	XFI125.02422	WOOD	12.47	150	30	3,9-5,1/2,8	36	10°	KON	HW	FI152.03630	WOOD	12.46
125	22	4,3-5,5/3,2	24	10°	KON	HW	FI126.02422	WOOD	12.46	150	30	3,1-4,3/2,2	36	10°	KON	HW	FI153.03630	WOOD	12.46
125	22	2,8-3,4/2,2	10+10	10°	FLAT	PCD	XFL125.01022	WOOD	12.48	150	30	3,2/2,2	36	10°	ES	HW	FP150.03630L	WOOD	12.53
125	22	2,8-3,6/2,2	12+12	10°	FLAT	HW	FL125.01222	WOOD	12.48	150	30	3,2/2,2	36	10°	ES	HW	FP150.03630R	WOOD	12.53
125	30	1,5/1,1	12	14°	FLAT	HW	KA125.0123015	WOOD	12.25	150	30	2,6/1,6	48	15°	WZ (ATB)	HW	AA150.04830	WOOD	12.18/19
125	30	1,8/1,3	12	14°	FLAT	HW	KA125.0123018	WOOD	12.25	150	30	3,2/2,2	48	10°	WZ (ATB)	HW	CE150.04830	WOOD	12.29
125	30	2,0/1,4	12	14°	FLAT	HW	KA125.0123020	WOOD	12.25	150	30	2,2/1,6	48	10°	WZ (ATB)	HW	CG150.04830	WOOD	12.31
125	30	2,5/1,6	12	14°	FLAT	HW	KA125.0123025	WOOD	12.25	150	30	2,2/1,6	48		WZ (ATB)	HW	CH150.06030	ALU/LAMINATE	12.32
125	30	3,0/2,0	12	14°	FLAT	HW	KA125.0123030	WOOD	12.25	150	35	4,0/3,0	30		FLAT	HW	FR150.03035	WOOD	12.54
125	30	3,5/2,5	12	14°	FLAT	HW	KA125.0123035	WOOD	12.25	150	45	4,3-5,5/3,2	36	10°	KON	HW	FI151.03645	WOOD	12.46
125	30	4,0/2,8	12	14°	FLAT	HW	KA125.0123040	WOOD	12.25	150	50	3,4-4,5/2,2	36	10°	KON	HW	FI150.03650	WOOD	12.46
125	30	4,5/3,2	12	14°	FLAT	HW	KA125.0123045	WOOD	12.25	156,5	12,7	2,6/1,8	48	15°	WZ (ATB)	HW	AA156.04813	WOOD	12.18/19
125	30	5,0/4,0	12	14°	FLAT	HW	KA125.0123050	WOOD	12.25	160	16	2,6/1,6	24	15°	WZ (ATB)	HW	AA160.02416	WOOD	12.18/19
125	30	6,0/4,0	12	14°	FLAT	HW	KA125.0123060	WOOD	12.25	160	16	2,6/1,6	30	15°	WZ (ATB)	HW	AA160.03016	WOOD	12.18/19
125	30	7,0/6,0	12	14°	FLAT	HW	KA125.0123070	WOOD	12.25	160	16	2,6/1,6	40	-5°	FZ/TR (TCG)	HW	AL160.02416	ALU/LAMINATE	12.20
125	30	8,0/6,0	12	14°	FLAT	HW	KA125.0123080	WOOD	12.25	160	16	2,6/1,6	48	15°	WZ (ATB)	HW	AA160.04816	WOOD	12.18/19
125	30	9,0/6,0	12	14°	FLAT	HW	KA125.0123090	WOOD	12.25	160	20	2,4/1,6	4		FLAT	PCD	XGE160.10420	FIBRE CEMENT	12.24

D	d	B/c	Z	α	Teeth	Quality	Item No.	Materials	Page	D	d	B/c	Z	α	Teeth	Quality	Item No.	Materials	Page
160	20	2,4/1,6	8		FLAT	PCD	XGE160.10820	FIBRE CEMENT	12.24	180	45	4,8-5,6/3,5	36	10°	KON/FZ	PCD	XFI181.03645	WOOD	12.47
160	20	2,6/1,6	24	15°	WZ (ATB)	HW	AA160.02420	WOOD	12.18/19	180	50	4,3-5,5/3,2	44	10°	KON	HW	FI180.03650	WOOD	12.46
160	20	1,8/1,3	24	15°	WZ (ATB)	HW	AP160.02420	WOOD	12.21	180	50	4,4-5,0/3,2	44	10°	KON/FZ	PCD	XFI180.04450	WOOD	12.47
160	20	2,2/1,6	24	15°	WZ (ATB)	HW	AP161.02420	WOOD	12.21	180	55	4,3-5,5/3,2	36	10°	KON	HW	FI180.03655	WOOD	12.46
160	20	2,6/1,6	30	15°	WZ (ATB)	HW	AA160.03020	WOOD	12.18/19	184	16	2,6/1,6	30	15°	WZ (ATB)	HW	AA184.03016	WOOD	12.18/19
160	20	2,2/1,6	30	0°	TR	HW	LZ160.03020	MULTI-MATERIALS	12.59	184	16	2,6/1,6	56	15°	WZ (ATB)	HW	AA184.05616	WOOD	12.18/19
160	20	4,3-5,5/3,2	36	10°	KON	HW	FI161.03620	WOOD	12.46	190	16	2,6/1,6	24	15°	WZ (ATB)	HW	AA190.02416	WOOD	12.18/19
160	20	2,6/1,6	40	-5°	FZ/TR (TCG)	HW	AL160.02420	ALU	12.20	190	16	2,6/1,6	40	15°	WZ (ATB)	HW	AA190.03616	WOOD	12.18/19
160	20	2,6/1,6	48	15°	WZ (ATB)	HW	AA160.04820	WOOD	12.18/19	190	16	2,6/1,6	56	15°	WZ (ATB)	HW	AA190.05616	WOOD	12.18/19
160	20	1,8/1,3	48	18°	WZ (ATB)	HW	AP160.04820	WOOD	12.21	190	20	2,4/1,6	4		FLAT	PCD	XGE190.10420	FIBRE CEMENT	12.24
160	20	2,2/1,6	48	15°	WZ (ATB)	HW	AP161.04820	WOOD	12.21	190	20	2,6/1,6	24	15°	WZ (ATB)	HW	AA190.02420	WOOD	12.18/19
160	20	1,8/1,3	48	-5°	WZ (ATB)	HW	AR160.04820	WOOD	12.22	190	20	2,6/1,6	40	15°	WZ (ATB)	HW	AA190.03620	WOOD	12.18/19
160	20	1,8/1,3	48	-5°	FZ/TR (TCG)	HW	AT160.04820	ALU/LAMINATE	12.22	190	20	2,6/1,6	54	-5°	FZ/TR (TCG)	HW	AL190.03020	ALU/LAMINATE	12.20
160	20	2,2/1,6	56	-5°	FZ/TR (TCG)	HW	AL160.05620	ALU/LAMINATE	12.20	190	20	2,6/1,6	56	15°	WZ (ATB)	HW	AA190.05620	WOOD	12.18/19
160	20	1,8/1,3	56	12°	WZ (ATB)	HW	AP160.05620	WOOD	12.21	190	30	2,6/1,6	24	15°	WZ (ATB)	HW	AA190.02430	WOOD	12.18/19
160	30	2,6/1,6	24	15°	WZ (ATB)	HW	AA160.02430	WOOD	12.18/19	190	30	2,2/1,6	38	0°	TR	HW	LZ190.03830	MULTI-MATERIALS	12.59
160	30	2,6/1,6	30	15°	WZ (ATB)	HW	AA160.03030	WOOD	12.18/19	190	30	2,6/1,6	40	15°	WZ (ATB)	HW	AA190.03630	WOOD	12.18/19
160	30	4,3-5,5/3,2	36	10°	KON	HW	FI161.02430	WOOD	12.46	190	30	2,6/1,6	54	-5°	FZ/TR (TCG)	HW	AL190.03030	ALU/LAMINATE	12.20
160	30	3,2/2,2	48	15°	WZ (ATB)	HW	FM160.04830	WOOD	12.53	190	30	1,8/1,3	54	-5°	FZ/TR (TCG)	HW	AT190.05430	ALU/LAMINATE	12.22
160	45	4,3-5,5/3,2	36	10°	KON	HW	FI161.03645	WOOD	12.46	190	30	2,6/1,6	56	15°	WZ (ATB)	HW	AA190.05630	WOOD	12.18/19
160	45	4,4-5,0/3,2	36	10°	KON/FZ	PCD	XFI160.03645	WOOD	12.47	200	20	4,3-5,5/3,2	36	10°	KON	HW	FI200.03620	WOOD	12.46
160	55	4,3-5,5/3,2	36	10°	KON	HW	FI161.03655	WOOD	12.46	200	20	4,4-5,0/3,2	36	10°	KON/FZ	PCD	XFI200.03620	WOOD	12.47
160	55	4,5-5,7/3,2	36	10°	KON	HW	FI162.03655	WOOD	12.46	200	20	5,0-5,8/3,5	36	10°	KON/FZ	PCD	XFI202.03620	WOOD	12.47
160	55	4,4-5,0/3,2	36	10°	KON/FZ	PCD	XFI160.03655	WOOD	12.47	200	30	2,4/1,6	4		FLAT	PCD	XGE200.10430	FIBRE CEMENT	12.24
165	20	2,6/1,8	24	15°	WZ (ATB)	HW	AA165.02420	WOOD	12.18/19	200	30	2,4/1,6	8		FLAT	PCD	XGE200.10830	FIBRE CEMENT	12.24
165	20	1,7/1,3	24	18°	WZ (ATB)	HW	AP165.02420	WOOD	12.21	200	30	2,6/1,8	24	15°	WZ (ATB)	HW	AA200.02430	WOOD	12.18/19
165	20	1,7/1,3	40	18°	WZ (ATB)	HW	AP165.04020	WOOD	12.21	200	30	3,2/2,2	24	14°	WZ (ATB)	HW	CA200.02430	WOOD	12.26
170	30	2,6/1,6	30	15°	WZ (ATB)	HW	AA170.03030	WOOD	12.18/19	200	30	3,2/2,2	34	10°	WZ (ATB)	HW	CB200.03230	WOOD	12.27
170	30	2,6/1,6	52	15°	WZ (ATB)	HW	AA170.05230	WOOD	12.18/19	200	30	2,2/1,6	34	10°	WZ (ATB)	HW	CF200.03230	WOOD	12.31
180	20	2,6/1,6	24	15°	WZ (ATB)	HW	AA180.02420	WOOD	12.18/19	200	30	2,6/1,8	36	15°	WZ (ATB)	HW	AA200.03630	WOOD	12.18/19
180	20	4,3-5,5/3,2	36	10°	KON	HW	FI180.03620	WOOD	12.46	200	30	4,0/2,8	36	10°	WZ (ATB)	HW	CP200.03630	WOOD	12.33
180	20	4,4-5,0/3,2	36	10°	KON/FZ	PCD	XFI180.03620	WOOD	12.47	200	30	4,3-5,5/3,2	36	10°	KON	HW	FI200.03630	WOOD	12.46
180	20	5,8-6,6/4,0	36	10°	KON/FZ	PCD	XFI182.03620	WOOD	12.47	200	30	4,4-5,0/3,2	36	10°	KON/FZ	PCD	XFI200.03630	WOOD	12.47
180	20	2,6/1,6	40	15°	WZ (ATB)	HW	AA180.03020	WOOD	12.18/19	200	30	2,2/1,6	40	0°	TR	HW	LZ200.04030	MULTI-MATERIALS	12.59
180	20	2,6/1,6	48	-5°	FZ/TR (TCG)	HW	AL180.02420	ALU/LAMINATE	12.20	200	30	3,2/2,2	48	10°	WZ (ATB)	HW	CD200.04830	WOOD	12.28
180	20	2,6/1,6	56	15°	WZ (ATB)	HW	AA180.05620	WOOD	12.18/19	200	30	2,6/1,8	64	15°	WZ (ATB)	HW	AA200.06430	WOOD	12.18/19
180	30	2,6/1,6	24	15°	WZ (ATB)	HW	AA180.02430	WOOD	12.18/19	200	30	3,2/2,2	64	10°	WZ (ATB)	HW	CE200.06430	WOOD	12.29
180	30	2,0/1,4	24	14°	FLAT	HW	KA180.0243020	WOOD	12.25	200	30	2,2/1,6	64	10°	WZ (ATB)	HW	CG200.06430	WOOD	12.31
180	30	2,5/1,6	24	14°	FLAT	HW	KA180.0243025	WOOD	12.25	200	30	2,2/1,6	80		WZ (ATB)	HW	CH200.08030	WOOD	12.32
180	30	3,0/2,0	24	14°	FLAT	HW	KA180.0243030	WOOD	12.25	200	30	3,2/2,5	64	5°	FZ/TR (TCG)	HW	LA200.06430	ALU/PVC	12.55
180	30	3,5/2,5	24	14°	FLAT	HW	KA180.0243035	WOOD	12.25	200	30	3,2/2,5	64	-5°	FZ/TR (TCG)	HW	LB200.06430	ALU/PVC	12.56
180	30	4,0/2,8	24	14°	FLAT	HW	KA180.0243040	WOOD	12.25	200	30	3,0/2,5	64	5°	WZ/FA	HW	LE200.06430	PVC	12.57
180	30	5,0/4,0	24	14°	FLAT	HW	KA180.0243050	WOOD	12.25	200	32	3,2/2,5	64	5°	FZ/TR (TCG)	HW	LA200.06432	ALU/PVC	12.55
180	30	6,0/4,0	24	14°	FLAT	HW	KA180.0243060	WOOD	12.25	200	32	3,2/2,5	64	-5°	FZ/TR (TCG)	HW	LB200.06432	ALU/PVC	12.56
180	30	7,0/6,0	24	14°	FLAT	HW	KA180.0243070	WOOD	12.25	200	40	2,5/1,8	21+3	18°	WZ (ATB)	HW	FK200.02140	WOOD	12.41
180	30	8,0/6,0	24	14°	FLAT	HW	KA180.0243080	WOOD	12.25	200	45	4,3-5,5/3,2	36	10°	KON	HW	FI200.03645	WOOD	12.46
180	30	9,0/6,0	24	14°	FLAT	HW	KA180.0243090	WOOD	12.25	200	45	4,7-6,0/3,5	36	10°	KON	HW	FI201.03645	WOOD	12.46
180	30	10,0/6,0	24	14°	FLAT	HW	KA180.0243099	WOOD	12.25	200	45	4,4-5,0/3,2	36	10°	KON/FZ	PCD	XFI200.03645	WOOD	12.47
180	30	3,2/2,2	30	10°	WZ (ATB)	HW	CB180.03030	WOOD	12.27	200	45	4,8-5,6/3,5	36	10°	KON/FZ	PCD	XFI201.03645	WOOD	12.47
180	30	2,2/1,6	30	10°	WZ (ATB)	HW	CF180.03030	WOOD	12.31	200	45	5,8-6,6/4,0	36	10°	KON/FZ	PCD	XFI203.03645	WOOD	12.47
180	30	2,2/1,6	30	0°	TR	HW	LZ180.03430	MULTI-MATERIALS	12.59	200	65	4,3-5,5/3,2	36	10°	KON	HW	FI200.03665	WOOD	12.46
180	30	4,3-5,5/3,2	36	10°	KON	HW	FI180.03630	WOOD	12.46	200	65	4,7-6,0/3,5	36	10°	KON	HW	FI201.03665	WOOD	12.46
180	30	2,6/1,6	40	15°	WZ (ATB)	HW	AA180.03030	WOOD	12.18/19	200	65	4,5-5,7/3,2	36	10°	KON	HW	FI202.03665	WOOD	12.46
180	30	3,2/2,2	54	5°	WZ (ATB)	HW	FR180.05430	WOOD	12.54	200	65	4,4-5,0/3,2	36	10°	KON/FZ	PCD	XFI200.03665	WOOD	12.47
180	30	2,6/1,6	56	15°	WZ (ATB)	HW	AA180.05630	WOOD	12.18/19	200	65	4,8-5,6/3,5	36	10°	KON/FZ	PCD	XFI201.03665	WOOD	12.47
180	30	3,2/2,2	56	10°	WZ (ATB)	HW	CE180.05430	WOOD	12.29	200	80	4,3-5,5/3,2	36	10°	KON	HW	FI200.03680	WOOD	12.46
180	30	2,2/1,6	56	10°	WZ (ATB)	HW	CG180.05630	WOOD	12.31	210	25	2,8/1,8	36	15°	WZ (ATB)	HW	AA210.03625	WOOD	12.18/19
180	35	4,0/2,8	42	5°	WZ (ATB)	HW	FR180.04235	WOOD	12.54	210	30	2,8/1,8	24	15°	WZ (ATB)	HW	AA210.02430	WOOD	12.18/19
180	40	2,5/1,8	21+3	18°	WZ (ATB)	HW	FK180.02140	WOOD	12.41	210	30	1,8/1,2	24	25°	WZ (ATB)	HW	AP210.02430	WOOD	12.21
180	45	4,3-5,5/3,2	36	10°	KON	HW	FI180.03645	WOOD	12.46	210	30	2,8/1,8	36	15°	WZ (ATB)	HW	AA210.03630	WOOD	12.18/19
180	45	4,7-6,0/3,5	36	10°	KON	HW	FI181.03645	WOOD	12.46	210	30	2,2/1,6	40	0°	TR	HW	LZ210.04030	MULTI-MATERIALS	12.59
180	45	4,4-5,0/3,2	36	10°	KON/FZ	PCD	XFI180.03645	WOOD	12.47	210	30	1,8/1,2	48	15°	WZ (ATB)	HW	AP210.04830	WOOD	12.21

D	d	B/c	Z	α	Teeth	Quality	Item No.	Materials	Page	D	d	B/c	Z	α	Teeth	Quality	Item No.	Materials	Page
210	30	2,6/1,6	54	-5°	FZ/TR (TCG)	HW	AL210.03430	ALU/LAMINATE	12.20	250	30	3,2/2,2	80	5°	FZ/TR (TCG)	HW	FCT250.08030	WOOD	12.37
210	30	2,8/1,8	64	15°	WZ (ATB)	HW	AA210.06430	WOOD	12.18/19	250	30	3,4/2,6	80	5°	FZ/TR (TCG)	HW	LA250.08030	ALU/PVC	12.55
215	50	4,3-5,5/3,2	42	10°	KON	HW	FI215.04250	WOOD	12.46	250	30	3,4/2,6	80	-5°	FZ/TR (TCG)	HW	LB250.08030	ALU/PVC	12.56
215	50	4,4-5,0/3,2	42	10°	KON/FZ	PCD	XFI215.04250	WOOD	12.47	250	30	3,0/2,5	80	5°	WZ/FA	HW	LE250.08030	PVC	12.57
216	30	2,4/1,6	8		FLAT	PCD	XGE216.10830	FIBRE CEMENT	12.24	250	30	3,2/2,5	80	-3°	FZ/TR (TCG)	HW	MES250.08030	PLASTIC	12.58
216	30	3,0/2,0	24	-5°	WZ (ATB)	HW	AB216.02430	WOOD	12.20	250	30	2,6/2,0	80	-3°	WZ/FA	HW	MGS250.08030	PLASTIC/PVC	12.57
216	30	3,0/2,0	48	-5°	WZ (ATB)	HW	AB216.04830	WOOD	12.20	250	30	3,0/2,5	80	10°	WZ (ATB)	HW	MLS250.08030	WOOD	12.35
216	30	2,3/1,6	48	-5°	WZ (ATB)	HW	AP216.04830	WOOD	12.21	250	30	3,2/2,2	80	-2°	WZ (ATB)	HW	MMS250.08030	WOOD	12.36
216	30	3,0/2,0	60	-5°	WZ (ATB)	HW	AB216.06030	WOOD	12.20	250	30	2,8/2,2	80	3°	FZ/TR (TCG)	HW	MP250.08030	WOOD	12.38
216	30	2,3/1,6	60	-5°	WZ (ATB)	HW	AP216.06030	WOOD	12.21	250	30	3,2/2,2	24+2+2	18°	WZ (ATB)	HW	FH250.01830	WOOD	12.40
216	30	3,0/2,0	64	-5°	FZ/TR (TCG)	HW	AL216.06030	ALU/LAMINATE	12.20	250	32	3,4/2,6	60	5°	FZ/TR (TCG)	HW	LA250.06032	ALU/PVC	12.55
216	30	1,8/1,2	64	-5°	WZ (ATB)	HW	AR216.06430	WOOD	12.22	250	32	3,4/2,6	80	5°	FZ/TR (TCG)	HW	LA250.08032	ALU/PVC	12.55
216	30	2,3/1,6	64	-5°	FZ/TR (TCG)	HW	AT216.06430	ALU/LAMINATE	12.22	250	32	3,4/2,6	80	-5°	FZ/TR (TCG)	HW	LB250.08032	ALU/PVC	12.56
220	30	2,8/1,8	36	15°	WZ (ATB)	HW	AA220.03630	WOOD	12.18/19	250	32	2	128	18°	C	HS	PA250.12832	METAL	12.60
220	30	3,2/2,2	42	18°	HZ/DZ	HW	FB220.04230	WOOD	12.36	250	32	2	200	18°	BW	HS	PB250.20032	METAL	12.60
220	30	2,8/1,8	64	15°	WZ (ATB)	HW	AA220.06430	WOOD	12.18/19	250	35	3,2/2,2	60	10°	WZ (ATB)	HW	CDS250.06035	WOOD	12.28
220	30	3,0/2,0	64	-5°	FZ/TR (TCG)	HW	AL220.03430	ALU/LAMINATE	12.20	250	40	2	128	18°	C	HS	PA250.12840	METAL	12.60
225	30	2,6/1,8	34	15°	WZ (ATB)	HW	AA225.03430	WOOD	12.18/19	250	40	2	200	18°	BW	HS	PB250.20040	METAL	12.60
225	32	2	120	18°	C	HS	PA225.12032	METAL	12.60	250	60	3,2/2,2	24+2+2	18°	WZ (ATB)	HW	FH250.01860	WOOD	12.40
225	32	2	180	18°	BW	HS	PB225.18032	METAL	12.60	250	70	3,2/2,2	24+2+2	18°	WZ (ATB)	HW	FH250.01870	WOOD	12.40
225	40	2	120	18°	C	HS	PA225.12040	METAL	12.60	250	70	2,7/1,8	24+2+2	18°	WZ (ATB)	HW	FK250.02070	WOOD	12.41
230	30	2,4/1,6	6		FLAT	PCD	XGE230.10630	FIBRE CEMENT	12.24	250	80	3,2/2,2	24+2+2	18°	WZ (ATB)	HW	FH250.01880	WOOD	12.40
230	30	2,8/1,8	24	15°	WZ (ATB)	HW	AA230.02430	WOOD	12.18/19	260	30	2,5/1,8	60	-5°	WZ (ATB)	HW	AB260.06030	WOOD	12.20
230	30	2,8/1,8	36	15°	WZ (ATB)	HW	AA230.03630	WOOD	12.18/19	275	32	2,5	140	18°	C	HS	PA275.14032	METAL	12.60
230	30	2,2/1,6	40	0°	TR	HW	LZ230.04430	MULTI-MATERIALS	12.59	275	32	2,5	220	18°	BW	HS	PB275.22032	METAL	12.60
230	30	2,8/1,8	64	15°	WZ (ATB)	HW	AA230.06430	WOOD	12.18/19	275	40	2,5	140	18°	C	HS	PA275.14040	METAL	12.60
235	25	2,8/1,8	36	15°	WZ (ATB)	HW	AA235.03625	WOOD	12.18/19	280	30	3,2/2,2	60	10°	WZ (ATB)	HW	CDS280.06030	WOOD	12.28
235	30	2,8/1,8	36	15°	WZ (ATB)	HW	AA235.03630	WOOD	12.18/19	280	70	3,2/2,2	24+2+2	18°	WZ (ATB)	HW	FH280.02070	WOOD	12.40
235	30	2,8/1,8	64	15°	WZ (ATB)	HW	AA235.06430	WOOD	12.18/19	280	80	3,2/2,2	24+2+2	18°	WZ (ATB)	HW	FH280.02080	WOOD	12.40
240	30	2,8/1,8	36	15°	WZ (ATB)	HW	AA240.03630	WOOD	12.18/19	300	25,4	2,4/1,8	60	0°	TR	HW	LZ300.06026	MULTI-MATERIALS	12.59
240	30	2,8/1,8	72	15°	WZ (ATB)	HW	AA240.07230	WOOD	12.18/19	300	30	2,4/1,6	12		FLAT	PCD	XGE300.11230	FIBRE CEMENT	12.24
240	40	3,2/2,2	34	5°	WZ (ATB)	HW	FR240.03440	WOOD	12.54	300	30	3,2/2,2	20	10°	FZ/FA	HW	GA300.02030	WOOD	12.34
250	20	2,4/1,8	48	0°	TR	HW	LZ250.04820	MULTI-MATERIALS	12.59	300	30	2,4/1,6	20		FLAT	PCD	XGE300.12030	FIBRE CEMENT	12.24
250	30	2,4/1,6	6		FLAT	PCD	XGE250.10630	FIBRE CEMENT	12.24	300	30	3,2/2,2	24	18°	FLAT	HW	DA300.02030	WOOD	12.33
250	30	2,4/1,6	12		FLAT	PCD	XGE250.11230	FIBRE CEMENT	12.24	300	30	3,2/2,2	28	18°	WZ (ATB)	HW	DC300.02830	WOOD	12.34
250	30	3,2/2,2	20	18°	FLAT	HW	DA250.01830	WOOD	12.33	300	30	3,2/2,2	36	14°	WZ (ATB)	HW	CA300.03630	WOOD	12.26
250	30	3,2/2,2	24	18°	WZ (ATB)	HW	DC250.02430	WOOD	12.34	300	30	4,0/2,8	36	-5°	WZ (ATB)	HW	FAS300.03630	WOOD	12.26
250	30	3,2/2,2	30	14°	WZ (ATB)	HW	CA250.03030	WOOD	12.26	300	30	3,2/2,2	48	10°	WZ (ATB)	HW	CBS300.04830	WOOD	12.27
250	30	3,2/2,2	40	10°	WZ (ATB)	HW	CBS250.04230	WOOD	12.27	300	30	2,2/1,6	48	10°	WZ (ATB)	HW	CF300.04830	WOOD	12.31
250	30	2,2/1,6	40	10°	WZ (ATB)	HW	CF250.04030	WOOD	12.31	300	30	4,0/2,8	48	10°	WZ (ATB)	HW	CP300.04830	WOOD	12.33
250	30	4,0/2,8	40	10°	WZ (ATB)	HW	CP250.04030	WOOD	12.33	300	30	4,4/3,2	48	16°	WZ (ATB)	HW	HBS300.04830	WOOD	12.49
250	30	2,4/1,6	42	15°	WZ (ATB)	HW	AP250.04230	WOOD	12.21	300	30	3,2/2,2	60	10°	WZ (ATB)	HW	CCS300.06030	WOOD	12.27
250	30	3,2/2,2	48	10°	WZ (ATB)	HW	CCS250.04830	WOOD	12.27	300	30	3,2/2,2	60	18°	HZ/DZ	HW	FB303.06030	WOOD	12.36
250	30	3,2/2,2	48	18°	HZ/DZ	HW	FB253.04830	WOOD	12.36	300	30	4,4/3,2	60	16°	WZ (ATB)	HW	HBS300.06030	WOOD	12.49
250	30	2,4/1,8	48	0°	TR	HW	LZ250.04830	MULTI-MATERIALS	12.59	300	30	4,4/3,2	60	16°	FZ/TR (TCG)	HW	HCS300.06030	WOOD	12.50/51
250	30	3,2/2,2	48	10°	FZ/TR (TCG)	PCD	XFC250.04830	WOOD	12.38	300	30	2,4/1,8	60	0°	TR	HW	LZ300.06030	MULTI-MATERIALS	12.59
250	30	3,2/2,2	60	10°	WZ (ATB)	HW	CDS250.06030	WOOD	12.28	300	30	3,2/2,2	60	10°	FZ/TR (TCG)	PCD	XFC300.06030	WOOD	12.38
250	30	3,2/2,2	60	10°	WZ (ATB)	HW	CDS250.06030.X6F	WOOD	12.30	300	30	4,4/3,2	60	16°	FZ/TR (TCG)	PCD	XHC300.06030	WOOD	12.52
250	30	3,2/2,2	60	10°	WZ (ATB)	HW	CDT250.06030	WOOD	12.28	300	30	3,2/2,2	72	10°	WZ (ATB)	HW	CDS300.07230	WOOD	12.28
250	30	3,2/2,2	60	10°	FZ/TR (TCG)	HW	FCS250.06030	WOOD	12.37	300	30	3,2/2,2	72	10°	WZ (ATB)	HW	CDS300.07230.X6F	WOOD	12.30
250	30	3,2/2,2	60	5°	FZ/TR (TCG)	HW	FCT250.06030	WOOD	12.37	300	30	3,2/2,2	72	10°	WZ (ATB)	HW	CDT300.07230	WOOD	12.28
250	30	3,4/2,6	60	5°	FZ/TR (TCG)	HW	LA250.06030	ALU/PVC	12.55	300	30	4,0/2,8	72	10°	WZ (ATB)	HW	CP300.07230	WOOD	12.33
250	30	3,4/2,6	60	-5°	FZ/TR (TCG)	HW	LB250.06030	ALU/PVC	12.56	300	30	3,2/2,2	72	10°	FZ/TR (TCG)	HW	FCS300.07230	WOOD	12.37
250	30	3,2/2,5	60	-3°	FZ/TR (TCG)	HW	MES250.06030	PLASTIC	12.58	300	30	3,2/2,2	72	5°	FZ/TR (TCG)	HW	FCT300.07230	WOOD	12.37
250	30	3,2/2,2	60	10°	FZ/TR (TCG)	PCD	XFC250.06030	WOOD	12.38	300	30	4,4/3,2	72	16°	FZ/TR (TCG)	HW	HCS300.07230	WOOD	12.50/51
250	30	2,4/1,6	80	12°	WZ (ATB)	HW	AP250.08030	WOOD	12.21	300	30	3,4/2,6	72	5°	FZ/TR (TCG)	HW	LA300.07230	ALU/PVC	12.55
250	30	3,2/2,2	80	10°	WZ (ATB)	HW	CES250.08030	WOOD	12.29	300	30	3,4/2,6	72	-5°	FZ/TR (TCG)	HW	LB300.07230	ALU/PVC	12.56
250	30	3,2/2,2	80	10°	WZ (ATB)	HW	CES250.08030.X6F	WOOD	12.30	300	30	3,2/2,2	72	10°	FZ/TR (TCG)	PCD	XFC300.07230	WOOD	12.38
250	30	3,2/2,2	80	10°	WZ (ATB)	HW	CET250.08030	WOOD	12.29	300	30	3,4/2,6	84	5°	FZ/TR (TCG)	HW	LA300.08430	ALU/PVC	12.55
250	30	2,2/1,6	80	10°	WZ (ATB)	HW	CG250.08030	WOOD	12.31	300	30	3,4/2,6	84	-5°	FZ/TR (TCG)	HW	LB300.08430	ALU/PVC	12.56
250	30	2,2/1,6	100		WZ (ATB)	HW	CH250.10030	WOOD	12.32	300	30	3,2/2,5	84	-3°	FZ/TR (TCG)	HW	MES300.08430	PLASTIC	12.58
250	30	3,2/2,2	80	10°	FZ/TR (TCG)	HW	FCS250.08030	WOOD	12.37	300	30	2,6/2,0	84	-3°	WZ/FA	HW	MGS300.08430	PLASTIC/PVC	12.57

D	d	B/c	Z	α	Teeth	Quality	Item No.	Materials	Page	D	d	B/c	Z	α	Teeth	Quality	Item No.	Materials	Page
300	30	3,2/2,2	96	10°	WZ (ATB)	HW	CES300.09630	WOOD	12.29	330	50	4,4/3,2	60	16°	FZ/TR (TCG)	HW	HCS330.06050	WOOD	12.50/51
300	30	3,2/2,2	96	10°	WZ (ATB)	HW	CES300.09630.X6F	WOOD	12.30	330	50	4,4/3,2	60	16°	FZ/TR (TCG)	PCD	XHC330.06050	WOOD	12.52
300	30	3,2/2,2	96	10°	WZ (ATB)	HW	CET300.09630	WOOD	12.29	350	30	3,2/2,2	24	10°	FZ/FA	HW	GA350.02430	WOOD	12.34
300	30	2,2/1,6	96	10°	WZ (ATB)	HW	CG300.09630	WOOD	12.31	350	30	3,5/2,5	28	18°	FLAT	HW	DA350.02430	WOOD	12.33
300	30	2,2/1,6	120		WZ (ATB)	HW	CH300.12030	WOOD	12.32	350	30	3,5/2,5	32	18°	WZ (ATB)	HW	DC350.03230	WOOD	12.34
300	30	3,2/2,2	96	10°	FZ/TR (TCG)	HW	FCS300.09630	WOOD	12.37	350	30	3,5/2,5	42	14°	WZ (ATB)	HW	CA350.04230	WOOD	12.26
300	30	3,2/2,2	96	5°	FZ/TR (TCG)	HW	FCT300.09630	WOOD	12.37	350	30	4,0/2,8	42	-5°	WZ (ATB)	HW	FAS350.04230	WOOD	12.26
300	30	3,4/2,6	96	5°	FZ/TR (TCG)	HW	LA300.09630	ALU/PVC	12.55	350	30	3,5/2,5	54	10°	WZ (ATB)	HW	CBS350.05430	WOOD	12.27
300	30	3,4/2,6	96	-5°	FZ/TR (TCG)	HW	LB300.09630	ALU/PVC	12.56	350	30	2,4/1,8	54	10°	WZ (ATB)	HW	CF350.05430	WOOD	12.31
300	30	3,0/2,5	96	5°	WZ/FA	HW	LE300.09630	PVC	12.57	350	30	4,4/3,2	54	16°	WZ (ATB)	HW	HBS350.05630	WOOD	12.49
300	30	3,2/2,5	96	-3°	FZ/TR (TCG)	HW	MES300.09630	PLASTIC	12.58	350	30	4,4/3,2	54	16°	FZ/TR (TCG)	HW	HCS350.05630	WOOD	12.50/51
300	30	2,6/2,0	96	-3°	WZ/FA	HW	MGS300.09630	PLASTIC/PVC	12.57	350	30	2,6/2,0	70	0°	TR	HW	LZ350.08030	MULTI-MATERIALS	12.59
300	30	3,0/2,5	96	10°	WZ (ATB)	HW	MLS300.09630	WOOD	12.35	350	30	3,5/2,5	72	10°	WZ (ATB)	HW	CCS350.07230	WOOD	12.27
300	30	3,0/2,5	96	5°	WZ (ATB)	HW	MMS300.09630	WOOD	12.36	350	30	3,5/2,5	72	18°	HZ/DZ	HW	FB350.07230	WOOD	12.36
300	30	2,8/2,2	96	3°	FZ/TR (TCG)	HW	MP300.09630	WOOD	12.38	350	30	4,4/3,2	72	16°	FZ/TR (TCG)	HW	HCS350.07230	WOOD	12.50/51
300	30	3,2/2,2	24+2+2	18°	WZ (ATB)	HW	FH300.02430	WOOD	12.40	350	30	3,5/2,5	72	10°	FZ/TR (TCG)	PCD	XFC350.07230	WOOD	12.38
300	32	3,4/2,6	72	5°	FZ/TR (TCG)	HW	LA300.07232	ALU/PVC	12.55	350	30	4,4/3,2	72	16°	FZ/TR (TCG)	PCD	XHC350.07230	WOOD	12.52
300	32	3,4/2,6	84	5°	FZ/TR (TCG)	HW	LA300.08432	ALU/PVC	12.55	350	30	3,5/2,5	84	10°	WZ (ATB)	HW	CDS350.08430	WOOD	12.28
300	32	3,4/2,6	84	-5°	FZ/TR (TCG)	HW	LB300.08432	ALU/PVC	12.56	350	30	3,5/2,5	84	10°	WZ (ATB)	HW	CDS350.08430.X6F	WOOD	12.30
300	32	3,4/2,6	96	5°	FZ/TR (TCG)	HW	LA300.09632	ALU/PVC	12.55	350	30	3,5/2,5	84	10°	WZ (ATB)	HW	CDT350.08430	WOOD	12.28
300	32	3,4/2,6	96	-5°	FZ/TR (TCG)	HW	LB300.09632	ALU/PVC	12.56	350	30	3,5/2,5	84	10°	FZ/TR (TCG)	HW	FCS350.08430	WOOD	12.37
300	32	2,5	160	18°	C	HS	PA300.16032	METAL	12.60	350	30	3,5/2,5	84	5°	FZ/TR (TCG)	HW	FCT350.08430	WOOD	12.37
300	32	2,5	220	18°	BW	HS	PB300.22032	METAL	12.60	350	30	3,4/2,6	84	5°	FZ/TR (TCG)	HW	LA350.08430	ALU/PVC	12.55
300	35	3,2/2,2	48	10°	WZ (ATB)	HW	CBS300.04835	WOOD	12.27	350	30	3,4/2,6	84	-5°	FZ/TR (TCG)	HW	LB350.08430	ALU/PVC	12.56
300	35	3,2/2,2	72	10°	WZ (ATB)	HW	CDS300.07235	WOOD	12.28	350	30	3,5/2,5	84	10°	FZ/TR (TCG)	PCD	XFC350.08430	WOOD	12.38
300	35	3,2/2,2	96	10°	FZ/TR (TCG)	HW	FCS300.09635	WOOD	12.37	350	30	3,4/2,6	96	5°	FZ/TR (TCG)	HW	LA350.09630	ALU/PVC	12.55
300	40	2,5	160	18°	C	HS	PA300.16040	METAL	12.60	350	30	3,4/2,6	96	-5°	FZ/TR (TCG)	HW	LB350.09630	ALU/PVC	12.56
300	40	2,5	220	18°	BW	HS	PB300.22040	METAL	12.60	350	30	3,5/2,5	96	10°	FZ/TR (TCG)	PCD	XFC350.09630	WOOD	12.38
300	50	3,2/2,2	24	5°	WZ (ATB)	HW	FR300.02450	WOOD	12.54	350	30	2,4/1,8	108	10°	WZ (ATB)	HW	CG350.10830	WOOD	12.31
300	50	4,3-5,5/3,2	48	10°	KON	HW	FI300.04850	WOOD	12.46	350	30	3,4/2,6	108	5°	FZ/TR (TCG)	HW	LA350.10830	ALU/PVC	12.55
300	60	3,2/2,2	24+2+2	18°	WZ (ATB)	HW	FH300.02460	WOOD	12.40	350	30	3,4/2,6	108	-5°	FZ/TR (TCG)	HW	LB350.10830	ALU/PVC	12.56
300	65	4,4/3,2	60	16°	FZ/TR (TCG)	HW	HCS300.06065	WOOD	12.50/51	350	30	3,2/2,5	108	5°	WZ/FA	HW	LE350.10830	PVC	12.57
300	65	4,4/3,2	60	16°	FZ/TR (TCG)	PCD	XHC300.06065	WOOD	12.52	350	30	3,5/2,5	108	5°	WZ (ATB)	HW	MMS350.10830	WOOD	12.36
300	65	4,3-5,5/3,2	72	10°	KON	HW	FI300.07265	WOOD	12.46	350	30	3,2/2,6	108	3°	FZ/TR (TCG)	HW	MP350.10830	WOOD	12.38
300	70	3,2/2,2	24	18°	FLAT	HW	DA300.02070	WOOD	12.33	350	30	3,5/2,5	112	10°	WZ (ATB)	HW	CES350.10830	WOOD	12.29
300	70	3,2/2,2	24	18°	WZ (ATB)	HW	FE300.02870	WOOD	12.39	350	30	3,5/2,5	112	10°	WZ (ATB)	HW	CES350.10830.X6F	WOOD	12.30
300	70	4,0/2,8	24+2+2	18°	WZ (ATB)	HW	FG300.02470	WOOD	12.39	350	30	3,5/2,5	112	10°	WZ (ATB)	HW	CET350.10830	WOOD	12.29
300	70	5,2/3,6	24+2+2	18°	WZ (ATB)	HW	FG301.02470	WOOD	12.39	350	30	3,5/2,5	112	10°	FZ/TR (TCG)	HW	FCS350.11230	WOOD	12.37
300	70	3,2/2,2	24+2+2	18°	WZ (ATB)	HW	FH300.02470	WOOD	12.40	350	30	3,5/2,5	112	5°	FZ/TR (TCG)	HW	FCT350.11230	WOOD	12.37
300	75	5,2/3,6	24+2+2	18°	WZ (ATB)	HW	FG301.02475	WOOD	12.39	350	30	3,2/2,5	112	-3°	FZ/TR (TCG)	HW	MES350.11230	PLASTIC	12.58
300	75	3,2/2,2	24+2+2	18°	WZ (ATB)	HW	FH300.02475	WOOD	12.40	350	30	3,5/2,5	24+2+4	18°	WZ (ATB)	HW	FH350.02630	WOOD	12.40
300	80	4,4/3,2	60	16°	FZ/TR (TCG)	HW	HCS300.06080	WOOD	12.50/51	350	32	3,4/2,6	84	5°	FZ/TR (TCG)	HW	LA350.08432	ALU/PVC	12.55
300	80	4,4/3,2	72	16°	FZ/TR (TCG)	HW	HCS300.07280	WOOD	12.50/51	350	32	3,4/2,6	84	-5°	FZ/TR (TCG)	HW	LB350.08432	ALU/PVC	12.56
300	80	4,0/2,8	24+2+2	18°	WZ (ATB)	HW	FG300.02480	WOOD	12.39	350	32	3,4/2,6	96	5°	FZ/TR (TCG)	HW	LA350.09632	ALU/PVC	12.55
300	80	5,2/3,6	24+2+2	18°	WZ (ATB)	HW	FG301.02480	WOOD	12.39	350	32	3,4/2,6	96	-5°	FZ/TR (TCG)	HW	LB350.09632	ALU/PVC	12.56
300	80	3,2/2,2	24+2+2	18°	WZ (ATB)	HW	FH300.02480	WOOD	12.40	350	32	3,4/2,6	108	5°	FZ/TR (TCG)	HW	LA350.10832	ALU/PVC	12.55
305	25,4	2,4/1,8	80	0°	TR	HW	LZ305.08026	MULTI-MATERIALS	12.59	350	32	3,4/2,6	108	-5°	FZ/TR (TCG)	HW	LB350.10832	ALU/PVC	12.56
305	30	2,6/1,8	48	-5°	WZ (ATB)	HW	AR305.04830	WOOD	12.22	350	32	2,5	180	18°	C	HS	PA350.18032	METAL	12.60
305	30	3,2/2,2	60	-5°	WZ (ATB)	HW	AB305.06030	WOOD	12.20	350	32	2,5	280	18°	BW	HS	PB350.28032	METAL	12.60
315	30	3,2/2,2	20	10°	FZ/FA	HW	GA315.02030	WOOD	12.34	350	35	3,5/2,5	32	18°	WZ (ATB)	HW	DC350.03235	WOOD	12.34
315	30	3,2/2,2	28	18°	WZ (ATB)	HW	DC315.02830	WOOD	12.34	350	35	3,5/2,5	54	10°	WZ (ATB)	HW	CBS350.05435	WOOD	12.27
315	30	3,2/2,2	48	10°	WZ (ATB)	HW	CB315.04830	WOOD	12.27	350	35	3,5/2,5	84	10°	WZ (ATB)	HW	CDS350.08435	WOOD	12.28
315	30	3,2/2,2	72	10°	WZ (ATB)	HW	CDS315.07230	WOOD	12.28	350	50	4,4/3,2	72	16°	FZ/TR (TCG)	HW	HCS350.07250	WOOD	12.50/51
315	32	2,5	160	18°	C	HS	PA315.16032	METAL	12.60	350	50	4,4/3,2	72	16°	FZ/TR (TCG)	PCD	XHC350.07250	WOOD	12.52
315	32	2,5	220	18°	BW	HS	PB315.22032	METAL	12.60	350	60	4,4/3,2	72	16°	FZ/TR (TCG)	HW	HCS350.07260	WOOD	12.50
315	40	2,5	220	18°	BW	HS	PB315.22040	METAL	12.60	350	60	4,4/3,2	72	16°	FZ/TR (TCG)	PCD	XHC350.07260	WOOD	12.52
320	50	4,4/3,2	60	16°	FZ/TR (TCG)	PCD	XHC320.06050	WOOD	12.52	350	60	3,5/2,5	24+2+4	18°	WZ (ATB)	HW	FH350.02660	WOOD	12.40
320	65	4,4/3,2	60	16°	FZ/TR (TCG)	HW	HCS320.06065	WOOD	12.50/51	350	65	4,4/3,2	72	16°	FZ/TR (TCG)	HW	HCS350.07265	WOOD	12.50/51
320	65	4,4/3,2	60	16°	FZ/TR (TCG)	PCD	XHC320.06065	WOOD	12.52	350	65	4,4/3,2	72	16°	FZ/TR (TCG)	PCD	XHC350.07265	WOOD	12.52
320	65	4,4/3,2	72	16°	FZ/TR (TCG)	HW	HCS320.07265	WOOD	12.50/51	350	70	4,2/2,8	24+2+4	18°	WZ (ATB)	HW	FG350.02470	WOOD	12.39
320	75	4,4/3,2	72	16°	FZ/TR (TCG)	HW	HCS320.07275	WOOD	12.50/51	350	70	3,5/2,5	24+2+4	18°	WZ (ATB)	HW	FH350.02870	WOOD	12.40
320	80	3,2/2,2	24+2+2	18°	WZ (ATB)	HW	FH320.02480	WOOD	12.40	350	75	4,4/3,2	54	16°	WZ (ATB)	HW	HBS350.05675	WOOD	12.49

D	d	B/c	Z	α	Teeth	Quality	Item No.	Materials	Page	D	d	B/c	Z	α	Teeth	Quality	Item No.	Materials	Page
350	75	4,4/3,2	54	16°	FZ/TR (TCG)	HW	HCS350.05675	WOOD	12.50/51	400	75	4,4/3,2	60	16°	FZ/TR (TCG)	HW	HCS400.06075	WOOD	12.50/51
350	75	4,4/3,2	72	16°	FZ/TR (TCG)	HW	HCS350.07275	WOOD	12.50/51	400	75	4,4/3,2	72	16°	WZ (ATB)	HW	HBS400.07275	WOOD	12.49
350	75	4,4/3,2	72	16°	FZ/TR (TCG)	PCD	XHC350.07275	WOOD	12.52	400	75	4,4/3,2	72	16°	FZ/TR (TCG)	HW	HCS400.07275	WOOD	12.50/51
350	75	4,2/2,8	24+2+2	18°	WZ (ATB)	HW	FG350.02475	WOOD	12.39	400	75	4,4/3,2	72	16°	FZ/TR (TCG)	PCD	XHC400.07275	WOOD	12.52
350	75	3,5/2,5	24+2+4	18°	WZ (ATB)	HW	FH350.02475	WOOD	12.40	400	75	4,0/2,8	28+2+4	18°	WZ (ATB)	HW	FH400.02875	WOOD	12.40
350	80	4,4/3,2	54	16°	WZ (ATB)	HW	HBS350.05680	WOOD	12.49	400	80	4,4/3,2	36	16°	WZ (ATB)	HW	HBS400.03680	WOOD	12.49
350	80	4,4/3,2	54	16°	FZ/TR (TCG)	HW	HCS350.05680	WOOD	12.50/51	400	80	4,4/3,2	60	16°	FZ/TR (TCG)	HW	HCS400.06080	WOOD	12.50/51
350	80	4,4/3,2	72	16°	FZ/TR (TCG)	HW	HCS350.07280	WOOD	12.50/51	400	80	4,4/3,2	72	16°	WZ (ATB)	HW	HBS400.07280	WOOD	12.49
350	80	4,6/3,2	72	16°	FZ/TR (TCG)	HW	HCS351.07280	WOOD	12.50/51	400	80	4,4/3,2	72	16°	FZ/TR (TCG)	HW	HCS400.07280	WOOD	12.50/51
350	80	4,4/3,2	72	16°	FZ/TR (TCG)	PCD	XHC350.07280	WOOD	12.52	400	80	4,6/3,2	72	16°	FZ/TR (TCG)	HW	HCS401.07280	WOOD	12.50/51
350	80	4,2/2,8	24+2+4	18°	WZ (ATB)	HW	FG350.02480	WOOD	12.39	400	80	4,4/3,2	72	16°	FZ/TR (TCG)	PCD	XHC400.07280	WOOD	12.52
350	80	3,5/2,5	24+2+4	18°	WZ (ATB)	HW	FH350.02480	WOOD	12.40	400	80	4,0/2,8	24+2+4	18°	WZ (ATB)	HW	FH400.02880	WOOD	12.40
350	90	3,5/2,5	24+2+4	18°	WZ (ATB)	HW	FH350.02490	WOOD	12.40	420	30	4,0/3,2	96	5°	FZ/TR (TCG)	HW	LA420.09630	ALU/PVC	12.55
355	25,4	2,6/2,0	80	0°	TR	HW	LZ355.08026	MULTI-MATERIALS	12.59	420	32	4,0/3,2	96	5°	FZ/TR (TCG)	HW	LA420.09632	ALU/PVC	12.55
355	30	4,4/3,2	72	16°	FZ/TR (TCG)	HW	HCS355.07230	WOOD	12.50/51	420	60	4,8/3,5	72	16°	FZ/TR (TCG)	PCD	XHC420.07260	WOOD	12.52
355	65	4,4/3,2	72	16°	FZ/TR (TCG)	HW	HCS355.07265	WOOD	12.50/51	420	80	4,4/3,2	72	16°	FZ/TR (TCG)	HW	HCS420.07280	WOOD	12.50/51
355	75	4,4/3,2	72	16°	FZ/TR (TCG)	HW	HCS355.07275	WOOD	12.50/51	430	75	4,4/3,2	72	16°	FZ/TR (TCG)	HW	HCS430.07275	WOOD	12.50/51
355	80	4,4/3,2	72	16°	FZ/TR (TCG)	HW	HCS355.07280	WOOD	12.50/51	430	75	4,8/3,5	72	16°	FZ/TR (TCG)	PCD	XHC430.07275	WOOD	12.52
360	50	4,4/3,2	72	16°	FZ/TR (TCG)	PCD	XHC360.07250	WOOD	12.52	430	80	4,4/3,2	72	16°	FZ/TR (TCG)	HW	HCS430.07280	WOOD	12.50/51
360	65	4,6/3,2	72	16°	FZ/TR (TCG)	HW	HCS361.07265	WOOD	12.50/51	430	80	4,8/3,5	72	16°	FZ/TR (TCG)	PCD	XHC430.07280	WOOD	12.52
360	65	4,4/3,2	72	16°	FZ/TR (TCG)	PCD	XHC360.07265	WOOD	12.52	450	30	4,2/2,8	40	18°	WZ (ATB)	HW	DC450.04030	WOOD	12.34
370	30	4,4/3,2	72	16°	FZ/TR (TCG)	HW	HCS370.07230	WOOD	12.50/51	450	30	4,2/2,8	54	14°	WZ (ATB)	HW	CA450.05430	WOOD	12.26
370	30	4,4/3,2	72	16°	FZ/TR (TCG)	PCD	XHC370.07230	WOOD	12.52	450	30	4,2/2,8	66	10°	WZ (ATB)	HW	CB450.06630	WOOD	12.27
380	60	4,4/3,2	72	16°	FZ/TR (TCG)	HW	HCS380.07260	WOOD	12.50/51	450	30	4,4/3,2	72	16°	FZ/TR (TCG)	HW	HCS450.07230	WOOD	12.50/51
380	60	4,8/3,5	72	16°	FZ/TR (TCG)	HW	HCS381.07260	WOOD	12.50/51	450	30	3,8/3,2	72	5°	FZ/TR (TCG)	HW	LA450.07330	ALU/PVC	12.55
380	60	4,8/3,5	72	16°	FZ/TR (TCG)	PCD	XHC380.07260	WOOD	12.52	450	30	4,4/3,2	72	16°	FZ/TR (TCG)	PCD	XHC450.07230	WOOD	12.52
380	65	4,4/3,2	72	16°	FZ/TR (TCG)	HW	HCS380.07265	WOOD	12.50/51	450	30	4,0/3,2	96	5°	FZ/TR (TCG)	HW	LA450.09630	ALU/PVC	12.55
380	75	4,4/3,2	72	16°	FZ/TR (TCG)	HW	HCS380.07275	WOOD	12.50/51	450	30	4,0/3,2	96	-5°	FZ/TR (TCG)	HW	LB450.09630	ALU/PVC	12.56
380	80	4,4/3,2	72	16°	FZ/TR (TCG)	HW	HCS380.07280	WOOD	12.50/51	450	30	4,2/2,8	108	10°	WZ (ATB)	HW	CD450.10830	WOOD	12.28
400	30	4,0/2,8	36	18°	WZ (ATB)	HW	DC400.03630	WOOD	12.34	450	30	4,0/3,2	108	5°	FZ/TR (TCG)	HW	LA450.10830	ALU/PVC	12.55
400	30	4,4/3,2	36	16°	WZ (ATB)	HW	HBS400.03630	WOOD	12.49	450	30	4,0/3,2	108	-5°	FZ/TR (TCG)	HW	LB450.10830	ALU/PVC	12.56
400	30	4,0/2,8	48	14°	WZ (ATB)	HW	CA400.04830	WOOD	12.26	450	30	3,8/3,2	120	5°	WZ/FA	HW	LE450.12030	PVC	12.57
400	30	4,2/2,8	48	-5°	WZ (ATB)	HW	FAS400.04830	WOOD	12.26	450	30	4,2/3,0	132	10°	WZ (ATB)	HW	CE450.13230	WOOD	12.29
400	30	4,0/2,8	60	10°	WZ (ATB)	HW	CBS400.06030	WOOD	12.27	450	30	4,6/3,5	132	5°	WZ (ATB)	HW	MRS450.13230	WOOD	12.54
400	30	4,4/3,2	60	16°	WZ (ATB)	HW	HBS400.06030	WOOD	12.49	450	30	4,6/3,2	24+2+4	18°	WZ (ATB)	HW	FH450.02430	WOOD	12.40
400	30	4,4/3,2	60	16°	FZ/TR (TCG)	HW	HCS400.06030	WOOD	12.50/51	450	32	3,8/3,2	72	5°	FZ/TR (TCG)	HW	LA450.07332	ALU/PVC	12.55
400	30	4,4/3,2	72	16°	WZ (ATB)	HW	HBS400.07230	WOOD	12.49	450	32	4,0/3,2	96	5°	FZ/TR (TCG)	HW	LA450.09632	ALU/PVC	12.55
400	30	4,4/3,2	72	16°	FZ/TR (TCG)	HW	HCS400.07230	WOOD	12.50/51	450	32	3,8/3,2	96	5°	FZ/TR (TCG)	HW	LA450.09732	ALU/PVC	12.55
400	30	4,4/3,2	72	16°	FZ/TR (TCG)	PCD	XHC400.07230	WOOD	12.52	450	32	4,0/3,2	96	-5°	FZ/TR (TCG)	HW	LB450.09632	ALU/PVC	12.56
400	30	4,0/2,8	80	10°	WZ (ATB)	HW	CCS400.08430	WOOD	12.27	450	32	4,0/3,2	108	5°	FZ/TR (TCG)	HW	LA450.10832	ALU/PVC	12.55
400	30	3,0/2,0	84	0°	TR	HW	LZ400.08430	MULTI-MATERIALS	12.59	450	32	4,0/3,2	108	-5°	FZ/TR (TCG)	HW	LB450.10832	ALU/PVC	12.56
400	30	4,0/2,8	96	10°	WZ (ATB)	HW	CDS400.09630	WOOD	12.28	450	60	4,8/3,5	72	16°	FZ/TR (TCG)	HW	HCS452.07260	WOOD	12.50/51
400	30	4,0/2,8	96	10°	WZ (ATB)	HW	CDT400.09630	WOOD	12.28	450	60	4,8/3,5	72	16°	FZ/TR (TCG)	PCD	XHC451.07260	WOOD	12.52
400	30	4,0/3,2	96	5°	FZ/TR (TCG)	HW	LA400.09630	ALU/PVC	12.55	450	70	4,6/3,2	24+2+4	18°	WZ (ATB)	HW	FH450.02470	WOOD	12.40
400	30	4,0/3,2	96	-5°	FZ/TR (TCG)	HW	LB400.09630	ALU/PVC	12.56	450	75	4,4/3,2	72	16°	FZ/TR (TCG)	HW	HCS450.07275	WOOD	12.50/51
400	30	3,4/2,8	108	3°	FZ/TR (TCG)	HW	MP400.10830	WOOD	12.38	450	75	4,6/3,2	24+2+4	18°	WZ (ATB)	HW	FH450.02475	WOOD	12.40
400	30	4,0/2,8	120	10°	WZ (ATB)	HW	CES400.12030	WOOD	12.29	450	80	4,8/3,5	48	16°	WZ (ATB)	HW	HBS451.04880	WOOD	12.49
400	30	4,0/2,8	120	10°	WZ (ATB)	HW	CET400.12030	WOOD	12.29	450	80	4,8/3,5	72	16°	FZ/TR (TCG)	HW	HCS452.07280	WOOD	12.50/51
400	30	4,0/3,2	120	5°	FZ/TR (TCG)	HW	LA400.12030	ALU/PVC	12.55	450	80	4,4/3,2	72	16°	FZ/TR (TCG)	PCD	XHC450.07280	WOOD	12.52
400	30	4,0/3,2	120	-5°	FZ/TR (TCG)	HW	LB400.12030	ALU/PVC	12.56	450	80	4,8/3,5	72	16°	FZ/TR (TCG)	PCD	XHC451.07280	WOOD	12.52
400	30	3,6/3,0	120	5°	WZ/FA	HW	LE400.12030	PVC	12.57	450	80	4,6/3,2	24+2+4	18°	WZ (ATB)	HW	FH450.02480	WOOD	12.40
400	30	4,6/3,5	120	5°	WZ (ATB)	HW	MRS400.12030	WOOD	12.54	450	90	4,6/3,2	24+2+4	18°	WZ (ATB)	HW	FH450.02490	WOOD	12.40
400	30	4,0/2,8	24+2+4	18°	WZ (ATB)	HW	FH400.03030	WOOD	12.40	460	30	4,4/3,2	72	16°	FZ/TR (TCG)	PCD	XHC460.07230	WOOD	12.52
400	32	4,0/3,2	96	5°	FZ/TR (TCG)	HW	LA400.09632	ALU/PVC	12.55	470	75	4,4/3,2	72	16°	FZ/TR (TCG)	PCD	XHC470.07275	WOOD	12.52
400	32	3,6/3,0	96	5°	FZ/TR (TCG)	HW	LA400.09732	ALU/PVC	12.55	480	30	4,4/3,2	72	16°	FZ/TR (TCG)	PCD	XHC480.07230	WOOD	12.52
400	32	4,0/3,2	96	-5°	FZ/TR (TCG)	HW	LB400.09632	ALU/PVC	12.56	480	60	4,8/3,5	72	16°	FZ/TR (TCG)	PCD	XHC481.07260	WOOD	12.52
400	32	4,0/3,2	120	5°	FZ/TR (TCG)	HW	LA400.12032	ALU/PVC	12.55	480	80	4,8/3,5	72	16°	FZ/TR (TCG)	PCD	XHC481.07280	WOOD	12.52
400	32	4,0/3,2	120	-5°	FZ/TR (TCG)	HW	LB400.12032	ALU/PVC	12.56	500	30	4,2/2,8	44	18°	WZ (ATB)	HW	DC500.04430	WOOD	12.34
400	60	4,4/3,2	72	16°	FZ/TR (TCG)	HW	HCS400.07260	WOOD	12.50/51	500	30	4,2/2,8	60	14°	WZ (ATB)	HW	CA500.06030	WOOD	12.26
400	60	4,4/3,2	72	16°	FZ/TR (TCG)	PCD	XHC400.07260	WOOD	12.52	500	30	4,2/2,8	72	10°	WZ (ATB)	HW	CB500.07230	WOOD	12.27
400	60	4,8/3,5	72	16°	FZ/TR (TCG)	PCD	XHC401.07260	WOOD	12.52	500	30	4,6/3,2	72	16°	WZ (ATB)	HW	HBS500.07230	WOOD	12.49
400	70	4,0/2,8	24+2+4	18°	WZ (ATB)	HW	FH400.03070	WOOD	12.40	500	30	4,0/3,2	96	5°	FZ/TR (TCG)	HW	LA500.09730	ALU/PVC	12.55

D	d	B/c	Z	α	Teeth	Quality	Item No.	Materials	Page
500	30	4,2/3,0	120	10°	WZ (ATB)	HW	CD500.12030	WOOD	12.28
500	30	4,6/3,6	120	5°	FZ/TR (TCG)	HW	LA500.12030	ALU/PVC	12.55
500	30	4,0/3,2	120	5°	FZ/TR (TCG)	HW	LA500.12130	ALU/PVC	12.55
500	30	4,6/3,6	120	-5°	FZ/TR (TCG)	HW	LB500.12030	ALU/PVC	12.56
500	30	4,0/3,2	120	-5°	FZ/TR (TCG)	HW	LB500.12130	ALU/PVC	12.56
500	30	4,0/3,2	120	5°	WZ/FA	HW	LE500.12030	PVC	12.57
500	30	4,2/3,0	144	10°	WZ (ATB)	HW	CE500.14430	WOOD	12.29
500	30	4,6/3,5	144	5°	WZ (ATB)	HW	MRS500.14430	WOOD	12.54
500	30	4,6/3,2	26+2+6	18°	WZ (ATB)	HW	FH500.02630	WOOD	12.40
500	32	4,0/3,2	96	5°	FZ/TR (TCG)	HW	LA500.09732	ALU/PVC	12.55
500	32	4,6/3,6	120	5°	FZ/TR (TCG)	HW	LA500.12032	ALU/PVC	12.55
500	32	4,0/3,2	120	5°	FZ/TR (TCG)	HW	LA500.12132	ALU/PVC	12.55
500	32	4,6/3,6	120	-5°	FZ/TR (TCG)	HW	LB500.12032	ALU/PVC	12.56
500	32	4,0/3,2	120	-5°	FZ/TR (TCG)	HW	LB500.12132	ALU/PVC	12.56
500	40	3,8/3,2	120	3°	FZ/TR (TCG)	HW	MP500.12040	WOOD	12.38
500	60	4,8/3,5	72	16°	FZ/TR (TCG)	PCD	XHC500.07260	WOOD	12.52
520	60	4,8/3,5	60	16°	FZ/TR (TCG)	PCD	XHC520.07260	WOOD	12.52
520	70	4,8/3,5	72	16°	FZ/TR (TCG)	HW	HCS520.07270	WOOD	12.50/51
550	30	4,2/3,0	48	18°	WZ (ATB)	HW	DC550.04430	WOOD	12.34
550	30	5,2/3,6	60	14°	WZ (ATB)	HW	CA550.06030	WOOD	12.26
550	30	4,2/3,6	120	5°	FZ/TR (TCG)	HW	LA550.12130	ALU/PVC	12.55
550	30	4,6/3,6	140	5°	FZ/TR (TCG)	HW	LA550.14030	ALU/PVC	12.55
550	30	4,2/3,6	140	5°	FZ/TR (TCG)	HW	LA550.14130	ALU/PVC	12.55
550	30	4,6/3,6	140	-5°	FZ/TR (TCG)	HW	LB550.14030	ALU/PVC	12.56
550	30	4,2/3,5	140	5°	WZ/FA	HW	LE550.14030	PVC	12.57
550	32	4,2/3,6	120	5°	FZ/TR (TCG)	HW	LA550.12132	ALU/PVC	12.55
550	32	4,2/3,6	140	5°	FZ/TR (TCG)	HW	LA550.14132	ALU/PVC	12.55
600	30	4,2/3,0	48	18°	WZ (ATB)	HW	DC600.05430	WOOD	12.34
600	30	5,2/3,6	60	14°	WZ (ATB)	HW	CA600.06030	WOOD	12.26
600	30	5,2/3,6	80	10°	WZ (ATB)	HW	CB600.08030	WOOD	12.27
600	30	4,6/3,6	140	5°	FZ/TR (TCG)	HW	LA600.14030	ALU/PVC	12.55
600	32	4,6/3,6	140	5°	FZ/TR (TCG)	HW	LA600.14032	ALU/PVC	12.55
600	40	4,6/3,6	140	5°	FZ/TR (TCG)	HW	LA600.14040	ALU/PVC	12.55
600	30	4,6/3,6	140	-5°	FZ/TR (TCG)	HW	LB600.14030	ALU/PVC	12.56
600	30	4,2/3,5	140	5°	WZ/FA	HW	LE600.14030	PVC	12.57
620	40	4,4/3,8	140	5°	FZ/TR (TCG)	HW	LA620.14040	ALU/PVC	12.55
650	30	5,0/4,0	140	-5°	FZ/TR (TCG)	HW	LB650.14030	ALU/PVC	12.56
650	40	5,0/4,0	140	5°	FZ/TR (TCG)	HW	LA650.14040	ALU/PVC	12.55
700	40	6,2/4,0	64	14°	WZ (ATB)	HW	CA700.06440	WOOD	12.26
700	40	6,2/4,0	84	10°	WZ (ATB)	HW	CB700.08440	WOOD	12.27
735	30	6,0/4,5	48+6	18°	WZ (ATB)	HW	DL0735.04830	WOOD	12.35
735	30	6,0/4,5	72+6	18°	WZ (ATB)	HW	DL0735.07230	WOOD	12.35
760	30	6,0/4,5	48+6	18°	WZ (ATB)	HW	DL0760.04830	WOOD	12.35
760	30	6,0/4,5	72+6	18°	WZ (ATB)	HW	DL0760.07230	WOOD	12.35
800	30	6,0/4,5	72+6	18°	WZ (ATB)	HW	DL0800.07230	WOOD	12.35
1000	80	8,5/6,0	72	18°	WZ (ATB)	HW	DL1000.07280	WOOD	12.35
1200	80	9,5/7,0	90+12	18°	WZ (ATB)	HW	DL1200.09080	WOOD	12.35

VISIT OUR WEBSITE
www.sistemklein.com



HW SAWBLADES FOR PORTABLE MACHINES

ART. AA

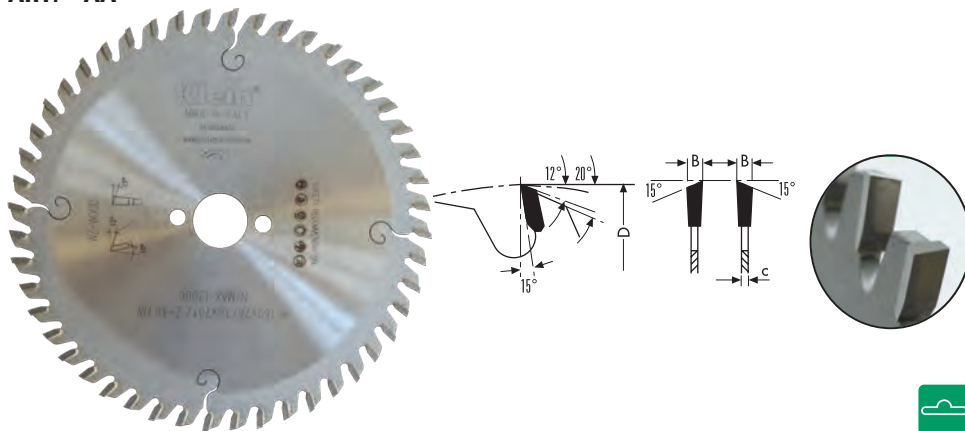

Item	D	d	B/c	Z	Pin holes	
AA127.03613	125	12,7	2,6/1,6	36		
AA130.02016	130	16	2,6/1,6	20		
AA130.03616	130	16	2,6/1,6	36		
AA134.03620	134	20	2,6/1,6	36		
AA140.02013	140	12,7	2,6/1,6	20		
AA140.02016	140	16	2,6/1,6	20		
AA140.02020	140	20	2,6/1,6	20		
AA140.03020	140	20	2,6/1,6	30		
AA140.04213	140	12,7	2,6/1,6	42		
AA140.04216	140	16	2,6/1,6	42		
AA140.04220	140	20	2,6/1,6	42		
AA150.02016	150	16	2,6/1,6	24		
AA150.02020	150	20	2,6/1,6	24		
AA150.02030	150	30	2,6/1,6	24		
AA150.03016	150	16	2,6/1,6	40		
AA150.03020	150	20	2,6/1,6	40		
AA150.04820	150	20	2,6/1,6	48		
AA150.04830	150	30	2,6/1,6	48		
AA156.04813	selling out	156,5	12,7	2,6/1,8	48	
AA160.02416	160	16	2,6/1,6	24	2/6/32	
AA160.02420	160	20	2,6/1,6	24	2/6/32	
AA160.02430	160	30	2,6/1,6	24	2/7/42	
AA160.03016	160	16	2,6/1,6	30	2/6/32	
AA160.03020	160	20	2,6/1,6	30	2/6/32	
AA160.03030	160	30	2,6/1,6	30	2/7/42	
AA160.04816	160	16	2,6/1,6	48	2/6/32	
AA160.04820	160	20	2,6/1,6	48	2/6/32	
AA165.02420	165	20	2,6/1,8	24		
AA170.03030	170	30	2,6/1,6	30	2/7/42	
AA170.05230	170	30	2,6/1,6	52	2/7/42	

TEETH FEATURES

- WZ (ATB) alternate top bevel teeth
- HW grade: KCR10

MATERIALS

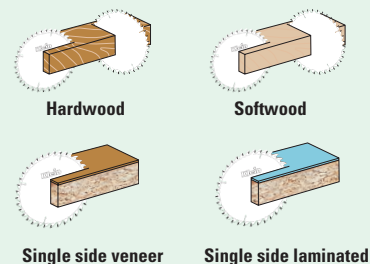

MACHINES

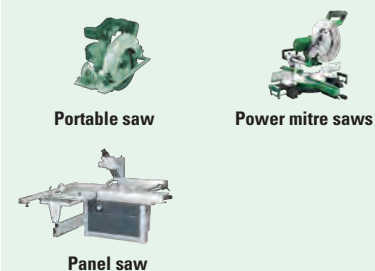

USEFUL INFORMATION

- Fine cut HW sawblades
- High teeth number sawblades are recommended for best finishing cut.
- Our items AA160.02420 - AA160.03020 - AA160.04820 are suitable for being used on Festool TS 55, TSC 55, ATF 55, AP 55.
- Our item AA225.03430 is suitable for Festool trimming saw PRECISIO CS70

HW SAWBLADES FOR PORTABLE MACHINES

ART. AA



Item	D	d	B/c	Z	Pin holes
AA180.02420	180	20	2,6/1,6	24	2/6/32
AA180.02430	180	30	2,6/1,6	24	2/7/42
AA180.03020	180	20	2,6/1,6	40	2/6/32
AA180.03030	180	30	2,6/1,6	40	2/7/42
AA180.05620	180	20	2,6/1,6	56	2/6/32
AA180.05630	180	30	2,6/1,6	56	2/7/42
AA184.03016	184	16	2,6/1,6	30	
AA184.05616	184	16	2,6/1,6	56	
AA190.02416	190	16	2,6/1,6	24	2/6/32
AA190.02420	190	20	2,6/1,6	24	2/6/32
AA190.02430	190	30	2,6/1,6	24	2/7/42
AA190.03616	190	16	2,6/1,6	40	2/6/32
AA190.03620	190	20	2,6/1,6	40	2/6/32
AA190.03630	190	30	2,6/1,6	40	2/7/42
AA190.05616	190	16	2,6/1,6	56	2/6/32
AA190.05620	190	20	2,6/1,6	56	2/6/32
AA190.05630	190	30	2,6/1,6	56	2/7/42
AA200.02430	200	30	2,6/1,8	24	2/7/42
AA200.03630	200	30	2,6/1,8	36	2/7/42
AA200.06430	200	30	2,6/1,8	64	2/7/42
AA210.02430	210	30	2,8/1,8	24	2/7/42
AA210.03625	210	25	2,8/1,8	36	2/7/42
AA210.03630	210	30	2,8/1,8	36	2/7/42
AA210.06430	210	30	2,8/1,8	64	2/7/42
AA220.03630	220	30	2,8/1,8	36	2/7/42
AA220.06430	220	30	2,8/1,8	64	2/7/42
AA225.03430	225	30	2,6/1,8	34	2/7/42
AA230.02430	230	30	2,8/1,8	24	2/7/42
AA230.03630	230	30	2,8/1,8	36	2/7/42
AA230.06430	230	30	2,8/1,8	64	2/7/42
AA235.03625	235	25	2,8/1,8	36	2/7/42
AA235.03630	235	30	2,8/1,8	36	2/7/42
AA235.06430	235	30	2,8/1,8	64	2/7/42
AA240.03630	240	30	2,8/1,8	36	2/7/42
AA240.07230	240	30	2,8/1,8	72	2/7/42

TEETH FEATURES

- WZ (ATB) alternate top bevel teeth
- HW grade: KCR10

MATERIALS

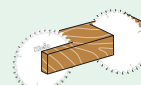

Hardwood

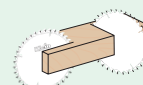

Softwood

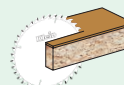

Single side veneer

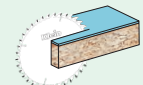

Single side laminated

MACHINES



Portable saw



Power mitre saws



Panel saw

USEFUL INFORMATION

- Fine cut HW sawblades
- High teeth number sawblades are recommended for best finishing cut.
- Our items AA160.02420 - AA160.03020 - AA160.04820 are suitable for being used on Festool TS 55, TSC 55, ATF 55, AP 55.
- Our item AA225.03430 is suitable for Festool trimming saw PRECISIO CS70

HW SAWBLADES FOR PORTABLE MACHINES

ART. AB

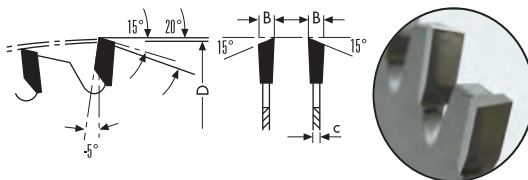

Item	D	d	B/c	Z	Pin holes
AB216.02430	216	30	3,0/2,0	24	
AB216.04830	216	30	3,0/2,0	48	
AB216.06030	216	30	3,0/2,0	60	
AB260.06030	260	30	2,5/1,8	60	PH02
AB305.06030	305	30	3,2/2,2	60	

TEETH FEATURES

- WZ (ATB) alternate top bevel teeth
- 5° negative hook angle
- HW grade: KCR10

MATERIALS

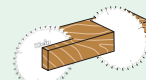

Hardwood

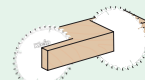

Softwood

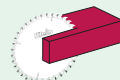

Plastic



Wood with nails

MACHINES



Power mitre saws



Portable saw



Panel saw

USEFUL INFORMATION

- Fine cut HW sawblades
- Pin holes: PH02=2/7/42 + 2/9,5/46,5 + 2/10/60

HW SAWBLADES FOR PORTABLE MACHINES

ART. AL

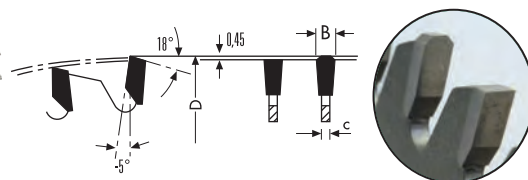

Item	D	d	B/c	Z	Pin holes
AL160.02416	160	16	2,6/1,6	40	
AL160.02420	160	20	2,6/1,6	40	2/6/32
AL160.05620	160	20	2,2/1,6	56	2/6/32
AL180.02420	180	20	2,6/1,6	48	2/6/32
AL190.03020	190	20	2,6/1,6	54	2/6/32
AL190.03030	190	30	2,6/1,6	54	2/7/42
AL210.03430	210	30	2,6/1,6	54	
AL216.06030	216	30	3,0/2,0	64	
AL220.03430	220	30	3,0/2,0	64	2/7/42

TEETH FEATURES

- FZ/TR (TCG) triple chip teeth
- 5° negative hook angle
- HW grade: KCR10

MATERIALS



Plastic



Wood with nails

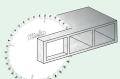

Aluminium profiles

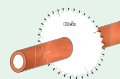

Copper

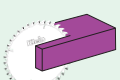

Solid surface



Brass

MACHINES



Power mitre saws



Portable saw



Panel saw

USEFUL INFORMATION

- Fine cut HW sawblades

EXTRA THIN PROFESSIONAL SAWBLADES



Fine hardmetal powder grain creates compact and sturdy carbide teeth that reduce abrasion, improve quality of the cut and increase life of the blade.



The special extra-thin kerf design allows fast and effortless cuts on cordless and portable saw, ensuring a higher feed rate and faster work progress.



Our laser-cut silent slots reduce noise, prevent sideways movement and improve cutting quality. The laser-cut expansion slots prevent stress and warping.



Our superior quality steel of the sawblade bodies is hardened up to HRC 46 and cut by laser to guarantee higher precision, less stress and better balancing.



EXTRA THIN PROFESSIONAL SAWBLADES

ART. AP

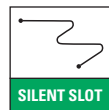
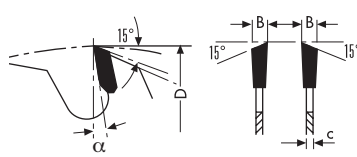

Item	D	d (reductions)	B/c	α	Z	Pin holes
AP085.02015 NEW	85	15 (10)	1,3/0,9	12°	20	
AP136.02420 NEW	136	20 (10)	1,5/1,0	20°	24	
AP160.02420 NEW	160	20 (16)	1,8/1,3	15°	24	2/6/32
AP160.04820 NEW	160	20 (16)	1,8/1,3	18°	48	2/6/32
AP160.05620 NEW	160	20 (16)	1,8/1,3	12°	56	2/6/32
AP161.02420 NEW	160	20 (16)	2,2/1,6	15°	24	2/6/32
AP161.04820 NEW	160	20 (16)	2,2/1,6	15°	48	2/6/32
AP165.02420 NEW	165	20 (16)	1,7/1,3	18°	24	2/6/32
AP165.04020 NEW	165	20 (16)	1,7/1,3	18°	40	2/6/32
AP210.02430 NEW	210	30 (1"-20)	1,8/1,2	25°	24	PH02
AP210.04830 NEW	210	30 (1"-20)	1,8/1,2	15°	48	PH02
AP250.04230 NEW	250	30 (1"-20)	2,4/1,6	15°	42	PH02
AP250.08030 NEW	250	30 (1"-20)	2,4/1,6	12°	80	PH02

TEETH FEATURES

- WZ (ATB) alternate top bevel teeth
- HW grade: KCR10

MATERIALS



Wood



Plywood

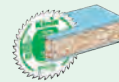

Laminate



MDF

MACHINES



Power mitre saws



Portable saw



Cordless

USEFUL INFORMATION

- The special extra-thin kerf design allows fast and effortless cuts on cordless and portable saw, ensuring a higher feed rate and faster work progress.
- Pin holes: PH02=2/7/42 + 2/9,5/46,5 + 2/10/60

EXTRA THIN PROFESSIONAL SAWBLADES

ART. AR

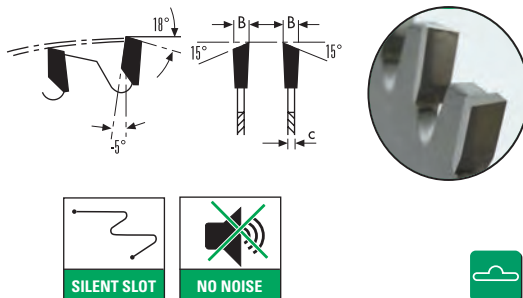

Item	D	d (reductions)	B/c	α	Z	Pin holes
AR160.04820 NEW	160	20 (16)	1,8/1,3	-5°	48	2/6/32
AR216.06430 NEW	216	30 (1"-20)	1,8/1,2	-5°	64	2/6/32
AR217.04830 NEW	216	30 (1"-20)	2,3/1,6	-5°	48	PH02
AR217.06030 NEW	216	30 (1"-20)	2,3/1,6	-5°	60	PH02
AR305.04830 NEW	305	30 (1"-20)	2,6/1,8	-5°	48	PH02

TEETH FEATURES

- WZ (ATB) alternate top bevel teeth
- HW grade: KCR10

MATERIALS

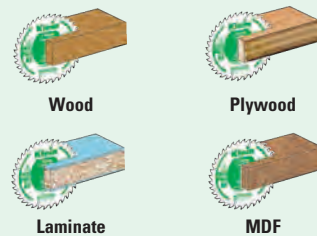

MACHINES



USEFUL INFORMATION

- The special extra-thin kerf design allows fast and effortless cuts on cordless and portable saw, ensuring a higher feed rate and faster work progress
- Pin holes: PH02=2/7/42 + 2/9,5/46,5 + 2/10/60

EXTRA THIN PROFESSIONAL SAWBLADES

ART. AT

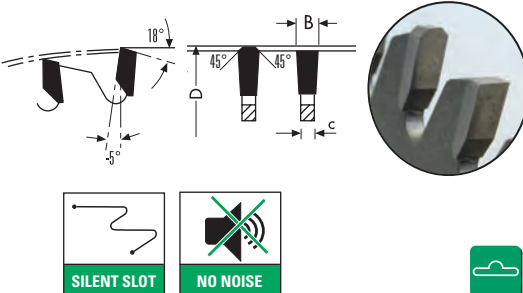

Item	D	d (reductions)	B/c	α	Z	Pin holes
AT160.04820 NEW	160	20 (16)	1,8/1,3	-5°	48	2/6/32
AT190.05430 NEW	190	30 (1"-20)	1,8/1,3	-5°	54	PH02
AT216.06430 NEW	216	30 (1"-20)	2,3/1,6	-5°	64	PH02



TEETH FEATURES

- FZ/TR (TCG) triple chip teeth trapezoidal
- HW grade: KCR10

MATERIALS

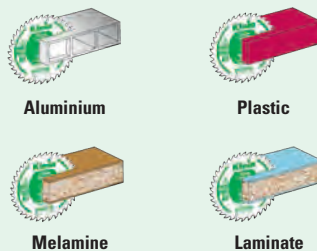

MACHINES



USEFUL INFORMATION

- The special extra-thin kerf design allows fast and effortless cuts on cordless and portable saw, ensuring a higher feed rate and faster work progress
- Pin holes: PH02=2/7/42 + 2/9,5/46,5 + 2/10/60

HW GROOVING CUTTER FOR "LAMELLO®"

ART. AH

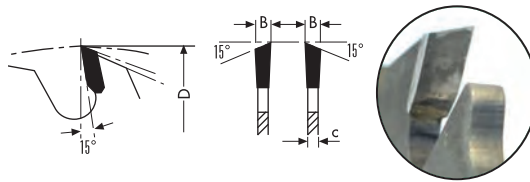

Item	D	d	B/c	Z
AH100.10622	100	22	3,96/2,8	8
AH100.21222	100	22	3,96/2,8	12

TEETH FEATURES

- WZ (ATB) alternate top bevel teeth
- HW grade: KCR10

MATERIALS

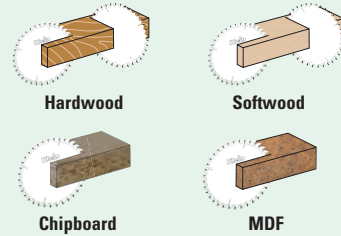

MACHINES



USEFUL INFORMATION

- For Lamello, Top 20, Top 21, Classic X

HW GROOVING CUTTER FOR "LAMELLO®"

ART. AH

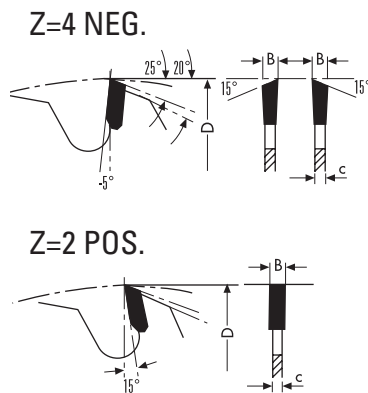

Item	D	d	B/c	Z	Pin holes
AH100.20622	100	22	3,96/2,8	2 pos.+4 neg.	4/4/36

TEETH FEATURES

- AH100.20622
- HW grade: KCR10

XAH100.20622

- DP tips (polycrystalline diamond) last almost forever (up to 30/50 times longer than standard carbide bits) save time and money

MATERIALS

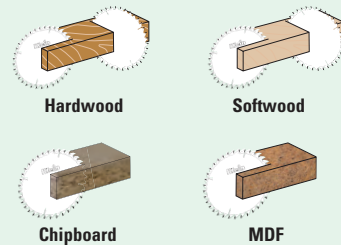

MACHINES



USEFUL INFORMATION

- For Lamello, Top 20, Top 21, Classic X

DP GROOVE CUTTER FOR "LAMELLO®"

ART. XAH

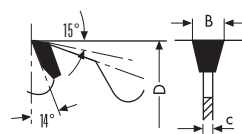

UP TO
30/50X
TOOL LIFE

Item	D	d	B/c	Z	Pin holes
XAH100.20622	100	22	3,96/2,8	3	4/4/36



DP GROOVE CUTTER FOR "LAMELLO®" - CLAMEX P

ART. XAH

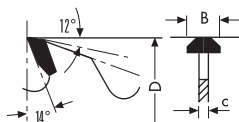

UP TO
30/50X
TOOL LIFE



Item	D	d	B	Z	Pin holes
XAH100.10330	100,4	30	7	3	4/6,6/48
XAH100.10630	100,4	30	7	6	4/6,6/48
XAH100.10322	100,4	22	7	3	4/4/36

TOOL SET FOR CNC

Art. T118...

Art. T128.140.R
T128.141.R
T128.145.R

Art. XAH...

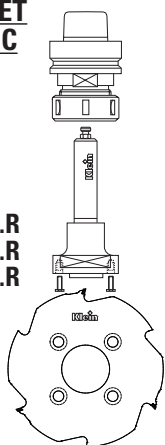

P-SYSTEM ANCHORAGE

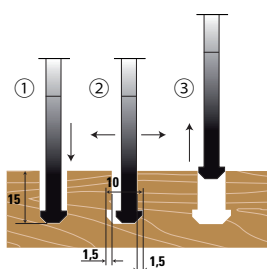

P-SYSTEM MACHINE



CLAMEX P JOINTS



TEETH FEATURES

- DP tips (polycrystalline diamond) last almost forever (up to 30/50 times longer than standard carbide bits) save time and money

MATERIALS

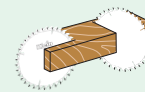

Hardwood

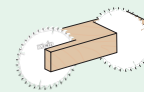

Softwood

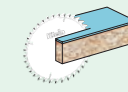

Single side laminated

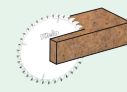

MDF

MACHINES



Jointer



CNC machining centres

USEFUL INFORMATION

- Suitable for making Clamex P connecting fittings for furniture, shelf units and kitchen making
- Recommended for grooving corner and longitudinal joints on hardwood, veneered and laminated MDF with the P-System anchorage
- For Zeta P2 Lamello machines

DP SAWBLADES FOR CUTTING ABRASIVE MATERIALS

ART. XGE

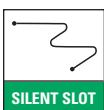
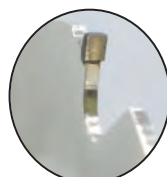
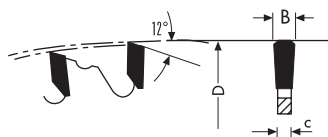

UP TO
30/50X
TOOL LIFE



Item	D	d	B/c	Z	Pin holes
XGE160.10420	160	20	2,4/1,6	4	2/6/32
XGE160.10820	160	20	2,4/1,6	8	2/6/32
XGE190.10420	190	20	2,4/1,6	4	2/6/32
XGE200.10430	200	30	2,4/1,6	4	2/7/42
XGE200.10830	200	30	2,4/1,6	8	2/7/42
XGE216.10830	216	30	2,4/1,6	8	-
XGE230.10630	230	30	2,4/1,6	6	2/7/42
XGE250.10630	250	30	2,4/1,6	6	PH02
XGE250.11230	250	30	2,4/1,6	12	PH02
XGE300.11230	300	30	2,4/1,6	12	PH02
XGE300.12030	300	30	2,4/1,6	20	PH02

TEETH FEATURES

- DP flat teeth
- DP tooth height 3,5 mm

MATERIALS

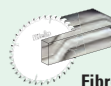

Fibre cement

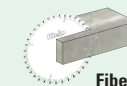

Fiberglass

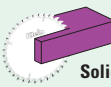

Solid surface

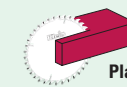

Plastic

MACHINES



Portable saw



Power miter saw



Table saw



Cordless

USEFUL INFORMATION

- Pin holes: PH02=2/7/42 + 2/9,5/46,5 + 2/10/60

HW GROOVING SAWBLADES

ART. KA

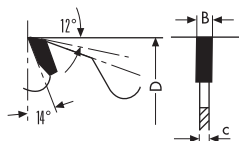

Item	D	d	B/c	Z
KA125.0123015	125	30	1,5/1,1	12
KA125.0123018	125	30	1,8/1,3	12
KA125.0123020	125	30	2,0/1,4	12
KA125.0123025	125	30	2,5/1,6	12
KA125.0123030	125	30	3,0/2,0	12
KA125.0123035	125	30	3,5/2,5	12
KA125.0123040	125	30	4,0/2,8	12
KA125.0123045	125	30	4,5/3,2	12
KA125.0123050	125	30	5,0/4,0	12
KA125.0123060	125	30	6,0/4,0	12
KA125.0123070	125	30	7,0/6,0	12
KA125.0123080	125	30	8,0/6,0	12
KA125.0123090	125	30	9,0/6,0	12
KA125.0123099	125	30	10,0/6,0	12
KA150.0183015	150	30	1,5/1,1	18
KA150.0183018	150	30	1,8/1,3	18
KA150.0183020	150	30	2,0/1,4	18
KA150.0183025	150	30	2,5/1,6	18
KA150.0183030	150	30	3,0/2,0	18
KA150.0183035	150	30	3,5/2,5	18
KA150.0183040	150	30	4,0/2,8	18
KA150.0183050	150	30	5,0/4,0	18
KA150.0183060	150	30	6,0/4,0	18
KA150.0183070	150	30	7,0/6,0	18
KA150.0183080	150	30	8,0/6,0	18
KA150.0183090	150	30	9,0/6,0	18
KA150.0183099	150	30	10,0/6,0	18
KA180.0243020	180	30	2,0/1,4	24
KA180.0243025	180	30	2,5/1,6	24
KA180.0243030	180	30	3,0/2,0	24
KA180.0243035	180	30	3,5/2,5	24
KA180.0243040	180	30	4,0/2,8	24
KA180.0243050	180	30	5,0/4,0	24
KA180.0243060	180	30	6,0/4,0	24
KA180.0243070	180	30	7,0/6,0	24
KA180.0243080	180	30	8,0/6,0	24
KA180.0243090	180	30	9,0/6,0	24
KA180.0243099	180	30	10,0/6,0	24

TEETH FEATURES

- FZ flat teeth
- HW grade: KCR05+ (K01-C4)

MATERIALS



Hardwood

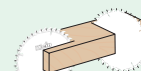

Softwood

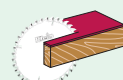

Plastic coated material

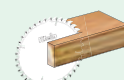

Plywood

MACHINES



Table saw



CNC machining centres

USEFUL INFORMATION

- For producing grooves with different width on every type of wood

HW RADIAL ARM SAWBLADES

ART. FAS

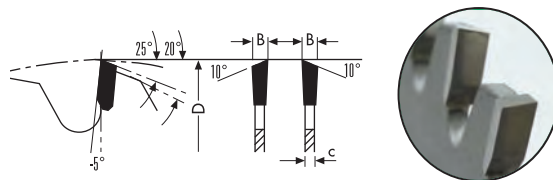

Item	D	d	B	Z	Pin holes
FAS300.03630	300	30	4,0/2,8	36	PH01
FAS350.04230	350	30	4,0/2,8	42	PH01
FAS400.04830	400	30	4,2/2,8	48	PH01

TEETH FEATURES

- WZ (ATB) alternate top bevel teeth
- HW grade: KCR10 (K10-C3)
- 5° negative hook angle

MATERIALS

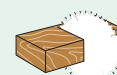

Hardwood



Softwood

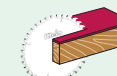

Plastic coated



Wood frames

MACHINES



Power mitre saws



Table saw

USEFUL INFORMATION

- Pin holes: PH01= 2/10/60

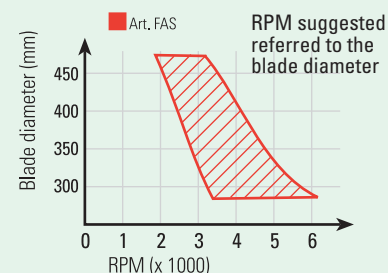

HW MULTI PURPOSE CIRCULAR SAWBLADES

ART. CA

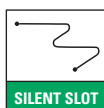
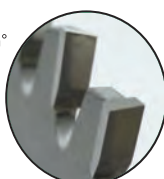
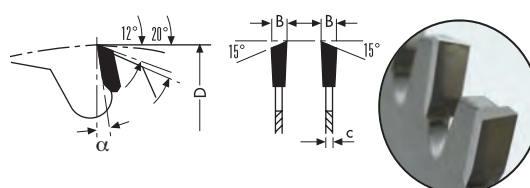

Item	D	d	B/c	Z	α	Pin holes
CA200.02430	200	30	3,2/2,2	24	14°	
CA250.03030	250	30	3,2/2,2	30	14°	PH02
CA300.03630	300	30	3,2/2,2	36	14°	PH02
CA350.04230	350	30	3,5/2,5	42	14°	PH02
CA400.04830	400	30	4,0/2,8	48	14°	PH02
CA450.05430	450	30	4,2/2,8	54	14°	PH01
CA500.06030	500	30	4,2/2,8	60	14°	PH01
CA550.06030	550	30	5,2/3,6	60	14°	PH01
CA600.06030	600	30	5,2/3,6	60	14°	PH01
CA700.06440	700	40	6,2/4,0	64	14°	PH01

TEETH FEATURES

- WZ (ATB) alternate top bevel teeth
- HW grade: KCR05+ (K01-C4)

MATERIALS



Hardwood

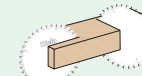

Softwood

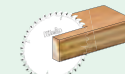

Plywood

MACHINES



Power mitre saws



Table saw



Panel saw

USEFUL INFORMATION

- Suitable for **particle board in stack**
- Pin holes: PH01= 2/10/60
PH02=2/7/42 + 2/9,5/46,5 + 2/10/60

HW CIRCULAR SAWBLADES FOR RIPPING AND CROSSCUTTING (MULTI PURPOSE)

ART. CB - CBS

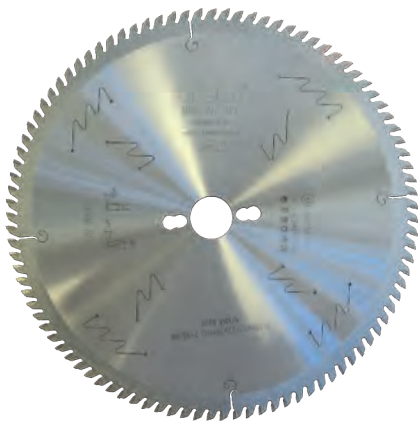

WATCH VIDEO

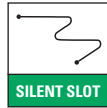
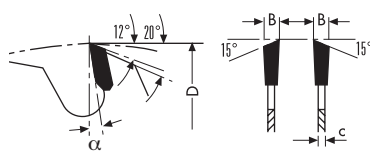

Item	D	d	B/c	Z	α	Pin holes
CB100.02020	100	20	3,2/2,2	20	10°	
CB120.02020	120	20	3,2/2,2	20	10°	
CB150.02430	150	30	3,2/2,2	24	10°	
CB180.03030	180	30	3,2/2,2	30	10°	
CB200.03230	200	30	3,2/2,2	34	10°	
CBS250.04230	250	30	3,2/2,2	40	10°	PH02
CBS300.04830	300	30	3,2/2,2	48	10°	PH02
CBS300.04835	300	35	3,2/2,2	48	10°	PH02
CB315.04830	315	30	3,2/2,2	48	10°	
CBS350.05430	350	30	3,5/2,5	54	10°	PH02
CBS350.05435	350	35	3,5/2,5	54	10°	PH02
CBS400.06030	400	30	4,0/2,8	60	10°	PH02
CB450.06630	450	30	4,2/2,8	66	10°	PH01
CB500.07230	500	30	4,2/2,8	72	10°	PH01
CB600.08030	600	30	5,2/3,6	80	10°	PH01
CB700.08440	700	40	6,2/4,0	84	10°	PH01

TEETH FEATURES

- WZ (ATB) alternate top bevel teeth
- HW grade: KCR05+ (K01-C4)

MATERIALS

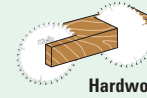

Hardwood



Softwood



Single side veneer

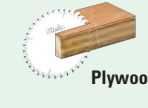

Plywood

MACHINES



Power mitre saws



Table saw



Panel saw

USEFUL INFORMATION

- Suitable for **particle board in stack**
- Pin holes: **PH01**= 2/10/60 - **PH02**=2/7/42 + 2/9,5/46,5 + 2/10/60

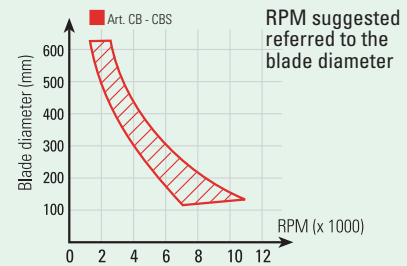

HW MULTI PURPOSE CIRCULAR SAWBLADES

ART. CCS

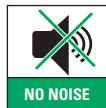
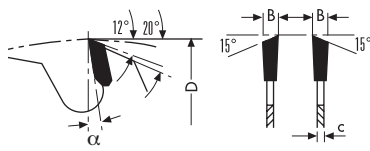

Item	D	d	B/c	Z	α	Pin holes
CCS250.04830	250	30	3,2/2,2	48	10°	PH02
CCS300.06030	300	30	3,2/2,2	60	10°	PH02
CCS350.07230	350	30	3,5/2,5	72	10°	PH02
CCS400.08430	400	30	4,0/2,8	80	10°	PH02

TEETH FEATURES

- WZ (ATB) alternate top bevel teeth
- HW grade: KCR05+ (K01-C4)

MATERIALS

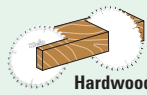

Hardwood



Single side veneer

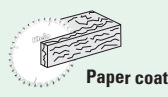

Paper coated

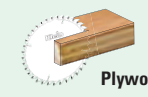

Plywood

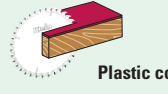

Plastic coated

MACHINES



Power mitre saws



Table saw



Panel saw

USEFUL INFORMATION

- Pin holes: **PH01**= 2/10/60
PH02=2/7/42 + 2/9,5/46,5 + 2/10/60

HW TRIMMING FINISHING

ART. CD-CDS

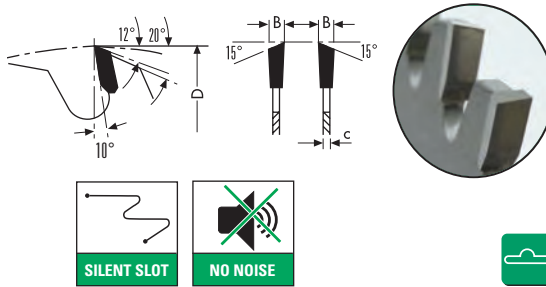

Item	D	d	B	Z	Pin holes
CD150.03630	150	30	3,2/2,2	36	
CD200.04830	200	30	3,2/2,2	48	
CDS250.06030	250	30	3,2/2,2	60	PH02
CDS250.06035	250	35	3,2/2,2	60	PH02
CDS280.06030	280	30	3,2/2,2	60	PH02
CDS300.07230	300	30	3,2/2,2	72	PH02
CDS300.07235	300	35	3,2/2,2	72	PH02
CDS315.07230	315	30	3,2/2,2	72	PH02
CDS350.08430	350	30	3,5/2,5	84	PH02
CDS350.08435	350	35	3,5/2,5	84	PH02
CDS400.09630	400	30	4,0/2,8	96	PH02
CD450.10830	450	30	4,2/2,8	108	PH01
CD500.12030	500	30	4,2/3,0	120	PH01

TEETH FEATURES

- WZ (ATB) alternate top bevel teeth
- HW grade: KCR05+ (K01-C4)

MATERIALS

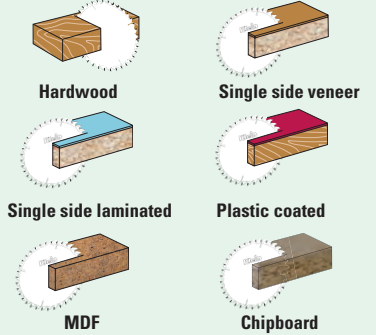

MACHINES



USEFUL INFORMATION

- Pin holes: PH01= 2/10/60 - PH02=2/7/42 + 2/9,5/46,5 + 2/10/60

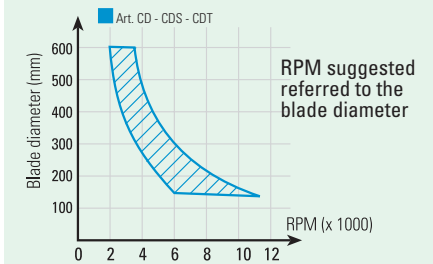

HW TRIMMING FINISHING

ART. CDT

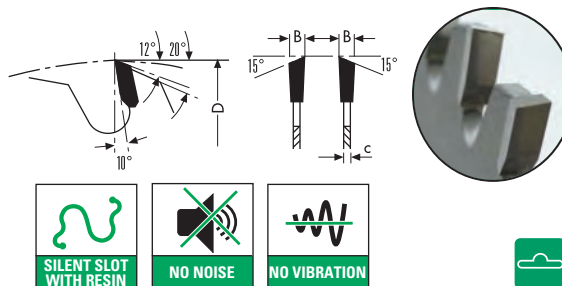

Item	D	d	B/c	Z	Pin holes
CDT250.06030	250	30	3,2/2,2	60	PH02
CDT300.07230	300	30	3,2/2,2	72	PH02
CDT350.08430	350	30	3,5/2,5	84	PH02
CDT400.09630	400	30	4,0/2,8	96	PH02

TEETH FEATURES

- WZ (ATB) alternate top bevel teeth
- HW grade: KCR05+ (K01-C4)

MATERIALS

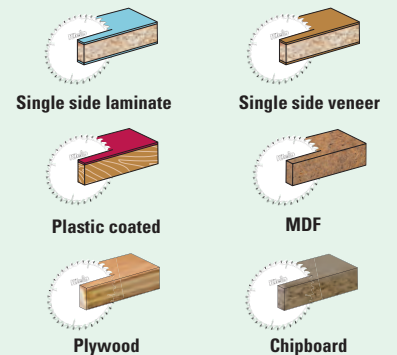

MACHINES



USEFUL INFORMATION

- Extra finish and long cutting life
- Pin holes: PH02=2/7/42 + 2/9,5/46,5 + 2/10/60

HW TRIMMING AND FINE FINISHING

ART. CE-CES

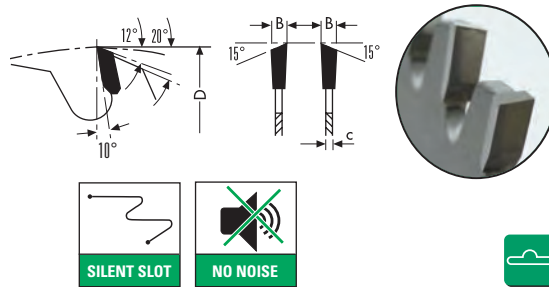

Item	D	d	B	Z	Pin holes
CE150.04830	150	30	3,2/2,2	48	
CE180.05430	180	30	3,2/2,2	56	
CE200.06430	200	30	3,2/2,2	64	
CES250.08030	250	30	3,2/2,2	80	PH02
CES300.09630	300	30	3,2/2,2	96	PH02
CES350.10830	350	30	3,5/2,5	112	PH02
CES400.12030	400	30	4,0/2,8	120	PH02
CE450.13230	450	30	4,2/3,0	132	PH01
CE500.14430	500	30	4,2/3,0	144	PH01

TEETH FEATURES

- WZ (ATB) alternate top bevel teeth
- HW grade: KCR05+ (K01-C4)

MATERIALS

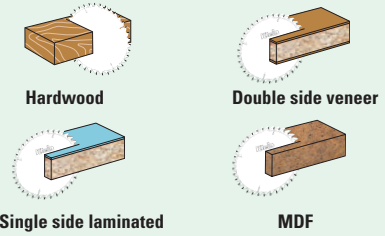

MACHINES



USEFUL INFORMATION

- Suitable for **particle board in stack**
- Pin holes: **PH01**= 2/10/60 - **PH02**=2/7/42 + 2/9,5/46,5 + 2/10/60

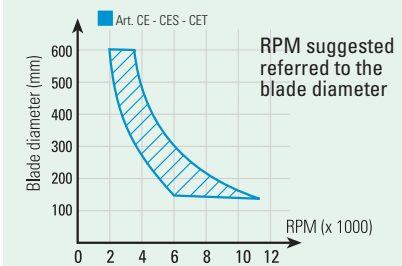

HW TRIMMING AND FINE FINISHING

ART. CET

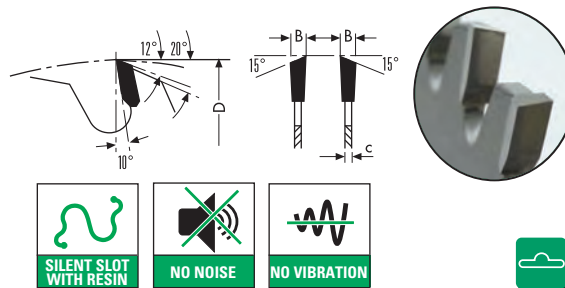

Item	D	d	B/c	Z	Pin holes
CET250.08030	250	30	3,2/2,2	80	PH02
CET300.09630	300	30	3,2/2,2	96	PH02
CET350.10830	350	30	3,5/2,5	112	PH02
CET400.12030	400	30	4,0/2,8	120	PH02

TEETH FEATURES

- WZ (ATB) alternate top bevel teeth
- HW grade: KCR05+ (K01-C4)

MATERIALS

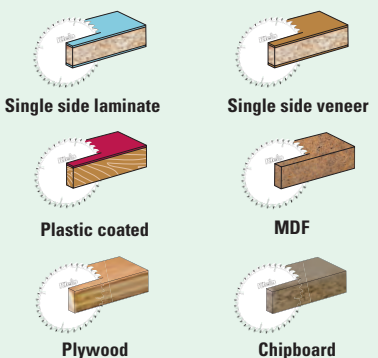

MACHINES



USEFUL INFORMATION

- Extra finish and long cutting life
- Pin holes: **PH02**=2/7/42 + 2/9,5/46,5 + 2/10/60



HW TRIMMING FINISHING SAW BLADES FOR HSK-63 ADAPTERS

ART. CDS.X6F

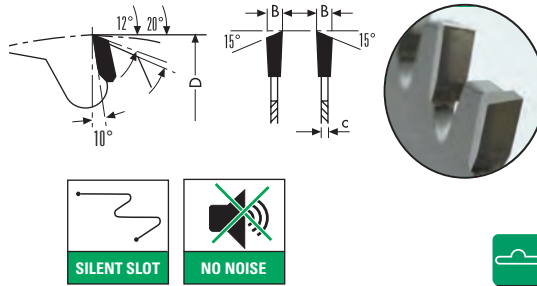

Item	D	d	B/c	Z	Pin holes
CDS250.06030.X6F	250	30	3,2/2,2	60	PH02 + 6/6/90
CDS300.07230.X6F	300	30	3,2/2,2	72	PH02 + 6/6/90
CDS350.08430.X6F	350	30	3,5/2,5	84	PH02 + 6/6/90

TEETH FEATURES

- WZ (ATB) alternate top bevel teeth
- HW grade: KCR05+ (K01-C4)

MATERIALS

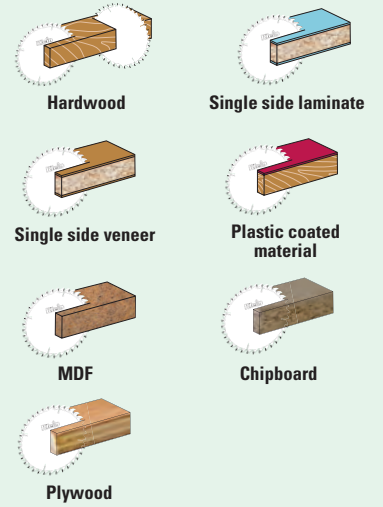

MACHINES



CNC machining centres

USEFUL INFORMATION

- With n° 6 countersunk holes for mounting on our HSK63 saw blade adapters (part number T128) aggregate for working on CNC router machines.
- Pin holes: PH02=2/7/42 + 2/9,5/46,5 + 2/10/60

HW TRIMMING FINISHING SAW BLADES FOR HSK-63 ADAPTERS

ART. CES.X6F

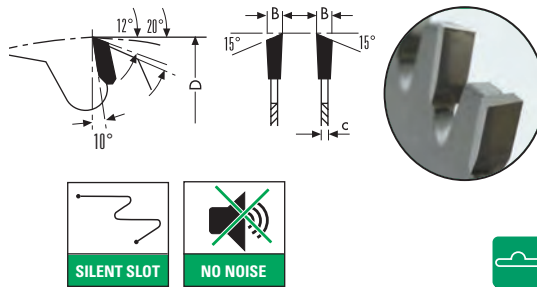

Item	D	d	B/c	Z	Pin holes
CES250.08030.X6F	250	30	3,2/2,2	80	PH02 + 6/6/90
CES300.09630.X6F	300	30	3,2/2,2	96	PH02 + 6/6/90
CES350.10830.X6F	350	30	3,5/2,5	112	PH02 + 6/6/90



Saw blade adapters (part number T128.165.R) see page 7.39

HW MULTI PURPOSE SAWBLADES (THIN KERF)

ART. CF

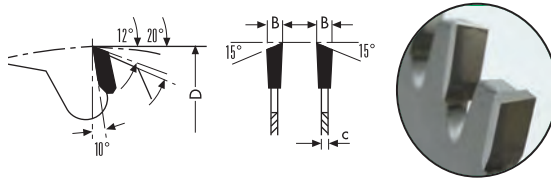

Item	D	d	B	Z	Pin holes
CF150.02430	150	30	2,2/1,6	24	
CF180.03030	180	30	2,2/1,6	30	
CF200.03230	200	30	2,2/1,6	34	
CF250.04030	250	30	2,2/1,6	40	PH02
CF300.04830	300	30	2,2/1,6	48	PH02
CF350.05430	350	30	2,4/1,8	54	PH02

TEETH FEATURES

- WZ (ATB) alternate top bevel teeth
- HW grade: KCR10

MATERIALS

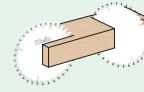

Softwood



Single side veneer



Plastic coated

MACHINES



Power mitre saws



Table saw



Panel saw

USEFUL INFORMATION

- Suitable for **particle board in stack**
- Extra fine finish
- For cutting expensive wood to reduce waste
- Pin holes: **PH02=2/7/42 + 2/9,5/46,5 + 2/10/60**

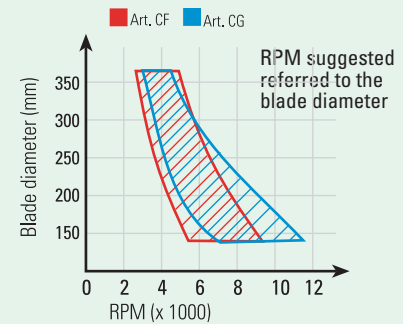

HW MULTI PURPOSE SAWBLADES (THIN KERF)

ART. CG

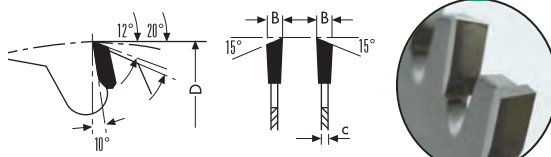

Item	D	d	B	Z	Pin holes
CG150.04830	150	30	2,2/1,6	48	
CG180.05630	180	30	2,2/1,6	56	
CG200.06430	200	30	2,2/1,6	64	
CG250.08030	250	30	2,2/1,6	80	PH02
CG300.09630	300	30	2,2/1,6	96	PH02
CG350.10830	350	30	2,4/1,8	108	PH02

TEETH FEATURES

- WZ (ATB) alternate top bevel teeth
- HW grade: KCR10

MATERIALS



Hardwood

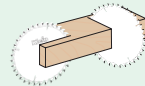

Softwood



MDF

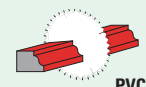

PVC frames

MACHINES



Power mitre saws



Table saw



Panel saw

USEFUL INFORMATION

- With thin kerf for less friction cuts
- Extra fine finish
- For separating plastic up to 10 mm cutting height chipboards
- Pin holes: **PH02=2/7/42 + 2/9,5/46,5 + 2/10/60**

HW MULTI PURPOSE SAWBLADES (THIN KERF)

ART. CH

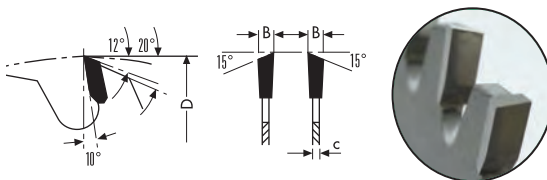

Item	D	d	B	Z	Pin holes
CH150.06030	150	30	2,2/1,6	60	
CH200.08030	200	30	2,2/1,6	80	
CH250.10030	250	30	2,2/1,6	100	PH02
CH300.12030	300	30	2,2/1,6	120	PH02

TEETH FEATURES

- WZ (ATB) alternate top bevel teeth
- HW grade: KCR10

MATERIALS

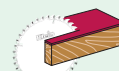

Plastic coated

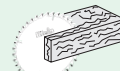

Paper coated

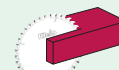

Plastic

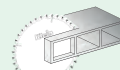

Aluminium profiles

MACHINES



Power mitre saws



Table saw



Panel saw

USEFUL INFORMATION

- With thin kerf for less friction cuts
- Pin holes: PH02=2/7/42 + 2/9,5/46,5 + 2/10/60

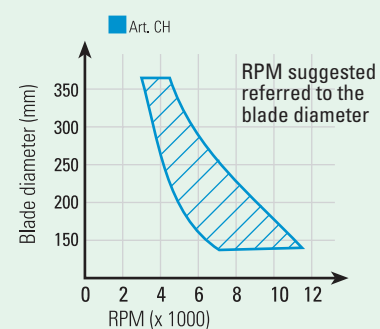

HW THICK KERF SAWBLADES

ART. CP

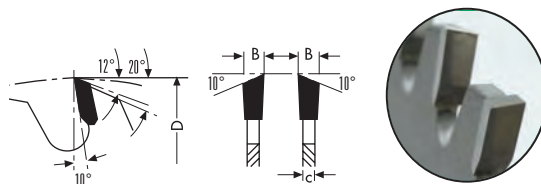

Item	D	d	B/c	Z	Pin holes
CP200.03630	200	30	4,0/2,8	36	PH02
CP250.04030	250	30	4,0/2,8	40	PH02
CP300.04830	300	30	4,0/2,8	48	PH02
CP300.07230	300	30	4,0/2,8	72	PH02

TEETH FEATURES

- WZ (ATB) alternate top bevel teeth
- HW grade: KCR05+ (K01-C4)

MATERIALS

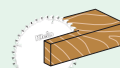

Hardwood



Softwood

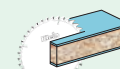

Single side laminate



Single side veneer

MACHINES



Power mitre saws



Table saw

USEFUL INFORMATION

- Heavy-duty thick kerf and plate for better stability and longer cutting life
- Pin holes: PH02=2/7/42 + 2/9,5/46,5 + 2/10/60

HW MULTI PURPOSE CIRCULAR SAWBLADES

ART. DA

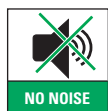
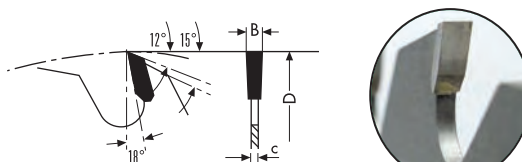

Item	D	d	B	Z	Pin holes
DA250.01830	250	30	3,2/2,2	20	PH02
DA300.02030	300	30	3,2/2,2	24	PH02
DA300.02070	300	70+ch (21x84)	3,2/2,2	24	PH02
DA350.02430	350	30	3,5/2,5	28	PH02

TEETH FEATURES

- FZ flat teeth
- HW grade: KCR10

MATERIALS

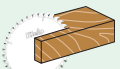

Hardwood



Softwood

MACHINES



Table saw



Multi-rip

USEFUL INFORMATION

- Suitable for particle board in stack
- Pin holes: PH02=2/7/42 + 2/9,5/46,5 + 2/10/60

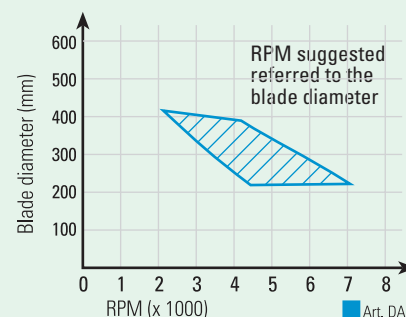

HW INDUSTRIAL RIPPING SAWBLADES

ART. DC

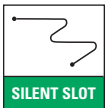
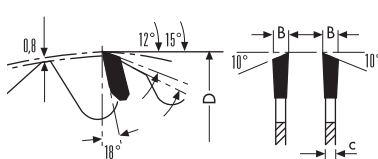
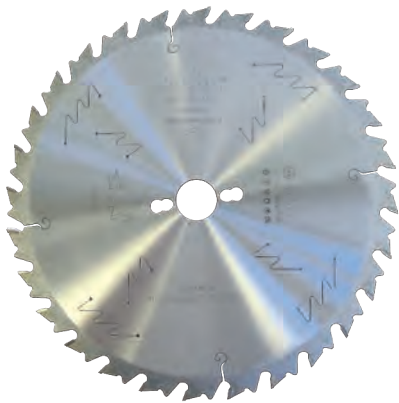

Item	D	d	B	Z	Pin holes
DC250.02430	250	30	3,2/2,2	24	PH02
DC300.02830	300	30	3,2/2,2	28	PH02
DC315.02830	315	30	3,2/2,2	28	PH02
DC350.03230	350	30	3,5/2,5	32	PH02
DC350.03235	350	35	3,5/2,5	32	PH02
DC400.03630	400	30	4,0/2,8	36	PH02
DC450.04030	450	30	4,2/2,8	40	PH01
DC500.04430	500	30	4,2/2,8	44	PH01
DC550.04430	550	30	4,2/3,0	48	PH01
DC600.05430	600	30	4,2/3,0	48	PH01

TEETH FEATURES

- WZ (ATB) alternate top bevel teeth
- HW grade: KCR10

MATERIALS

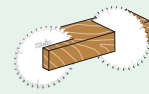

Hardwood



Softwood



Single side laminated



Single side veneer

MACHINES



Power mitre saws



Table saw



Panel saw

USEFUL INFORMATION

- Anti-kickback design
- Pin holes: **PH01** = 2/10/60 - **PH02** = 2/7/42 + 2/9,5/46,5 + 2/10/60

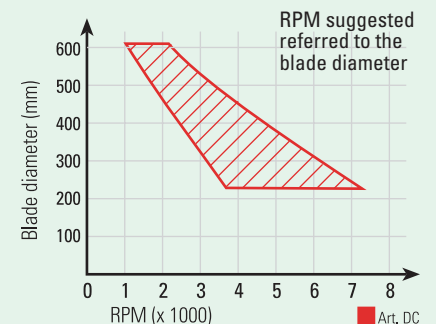

HW SAWBLADES FOR BUILDING SITES

ART. GA

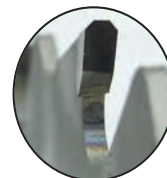
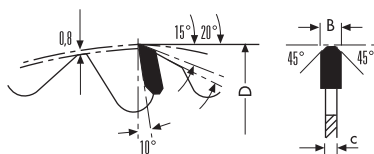

Item	D	d	B/c	Z	Pin holes
GA300.02030	300	30	3,2/2,2	20 +anti-kickback	PH01
GA315.02030	315	30	3,2/2,2	20 +anti-kickback	PH01
GA350.02430	350	30	3,2/2,2	24 +anti-kickback	PH01

TEETH FEATURES

- FZ/FA flat, beveled teeth with anti-kickback design
- HW grade: KCR10

MATERIALS



Wood with nails

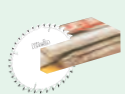

Building sites

MACHINES



Table saw



Power mitre saw

USEFUL INFORMATION

- Pin holes: **PH01** = 2/10/60

HW SAWBLADES FOR CUTTING BEAMS

ART. DL

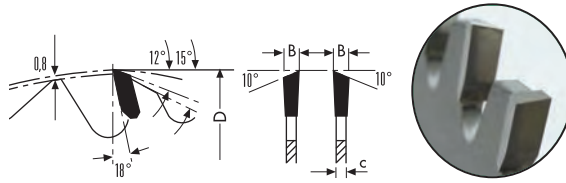

Item	D	d	B/c	Z	Machines
DL0735.04830	735	30	6,0/4,5	48+6	Hundegger
DL0735.07230	735	30	6,0/4,5	72+6	Hundegger
DL0760.04830	760	30	6,0/4,5	48+6	Hundegger
DL0760.07230	760	30	6,0/4,5	72+6	Hundegger
DL0800.07230	800	30	6,0/4,5	72+6	Hundegger
DL1000.07280	1000	80+8	8,5/6,0	72	Essetre
DL1200.09080	1200	80+8	9,5/7,0	90+12	Essetre

TEETH FEATURES

- WZ (ATB) alternate top bevel teeth
- HW grade: KCR10

MATERIALS

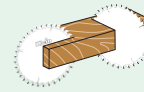

Hardwood

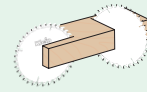

Softwood

MACHINES



Multi-rip

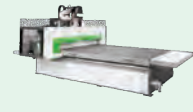

CNC machining centres



USEFUL INFORMATION

- With HW rakers for better cutting quality
- **Balanced sawblades to work in perfect stability**
- Possibility to reach high feed speeds (up to 20/30/40 mt/min)
- Ideal for vertical and horizontal cutting of beams, roof production and heavy wooden carpentry

HW FINE FINISHING SAWBLADES

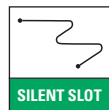
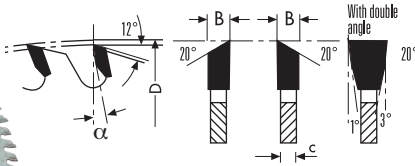
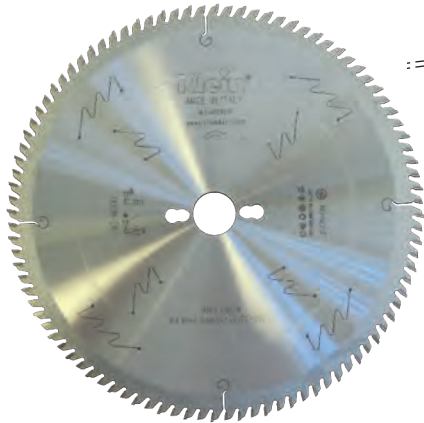
ART. MLS



Item	D	d	B/c	α	Z	Pin holes
MLS250.08030 	250	30	3,0/2,5	10°	80	PH02
MLS300.09630 	300	30	3,0/2,5	10°	96	PH02

TEETH FEATURES

- WZ (ATB) alternate top bevel teeth
- HW grade: KCR05+ (K01-C4)

MATERIALS



MDF



PVC

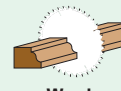

Wood frames

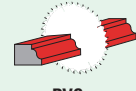

PVC frames

MACHINES



Power mitre saw



Table saw



Panel saw

USEFUL INFORMATION

- Ideal for cutting frames
- Excellent finish on 45° cut
- Pin holes: PH02=2/7/42 + 2/9,5/46,5 + 2/10/60

HW EXTRA FINE FINISHING SAWBLADES

ART. MMS

Xtra®
cut

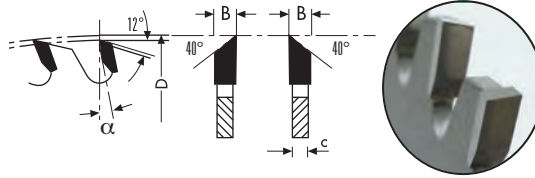

TEETH FEATURES

- WZ (ATB) alternate top bevel teeth
- HW grade: KCR05+ (K01-C4)

MATERIALS

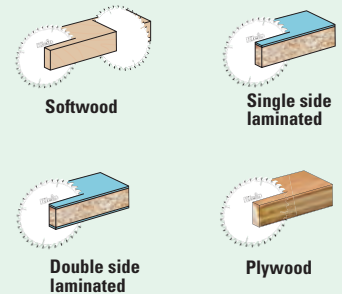

MACHINES



Item	D	d	B/c	α	Z	Pin holes
MMS250.08030	250	30	3,2/2,2	-2°	80	PH02
MMS300.09630	300	30	3,0/2,5	5°	96	PH02
MMS350.10830	350	30	3,5/2,5	5°	108	PH02

USEFUL INFORMATION

- Excellent finish on 45° cut
- Pin holes: **PH02**=2/7/42 + 2/9,5/46,5 + 2/10/60

HW TRIMMING AND SIZING SAWBLADES

ART. FB

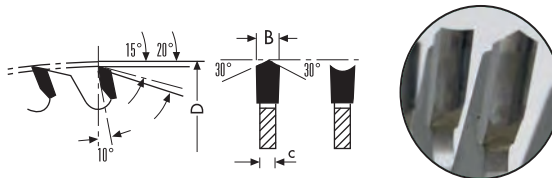

TEETH FEATURES

- HZ/DZ inverted "V" and hollow ground teeth
- HW grade: KCR05+ (K01-C4)

MATERIALS

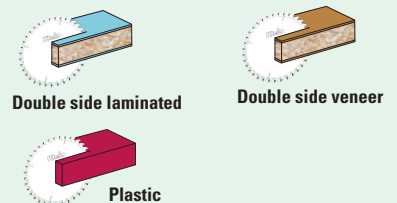

MACHINES



Item	D	d	B	Z	Pin holes
FB220.04230	220	30	3,2/2,2	42	
FB253.04830	250	30	3,2/2,2	48	PH02
FB303.06030	300	30	3,2/2,2	60	PH02
FB350.07230	350	30	3,5/2,5	72	PH02

USEFUL INFORMATION

- Extra finish and long cutting life
- These sawblades can work without the help of conical scoring saw blades
- Pin holes: **PH02**=2/7/42 + 2/9,5/46,5 + 2/10/60

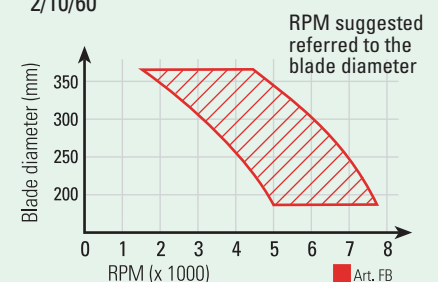

HW CIRCULAR SAWBLADES FOR BILAMINATED PANELS

ART. FCS

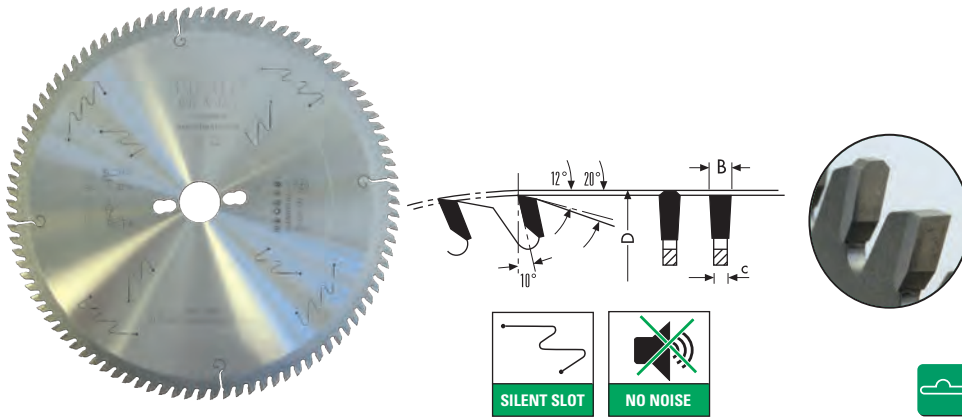

Item	D	d	B	Z	Pin holes
FCS250.06030	250	30	3,2/2,2	60	PH02
FCS250.08030	250	30	3,2/2,2	80	PH02
FCS300.07230	300	30	3,2/2,2	72	PH02
FCS300.09630	300	30	3,2/2,2	96	PH02
FCS300.09635	300	35	3,2/2,2	96	PH02
FCS350.08430	350	30	3,5/2,5	84	PH02
FCS350.11230	350	30	3,5/2,5	112	PH02

TEETH FEATURES

- FZ/TR (TCG) triple chip teeth trapezoidal
- (FCS) - HW grade: KCR05+ (K01-C4)
- (FCT) - HW grade: KCR10

MATERIALS

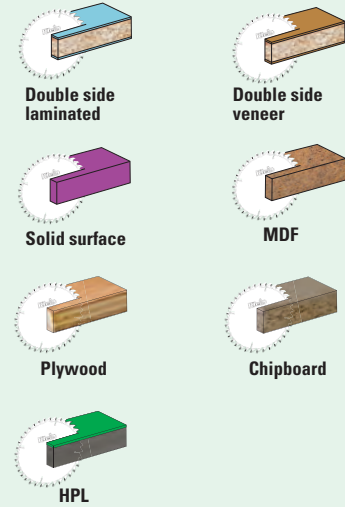

HW CIRCULAR SAWBLADES FOR BILAMINATED PANELS

ART. FCT

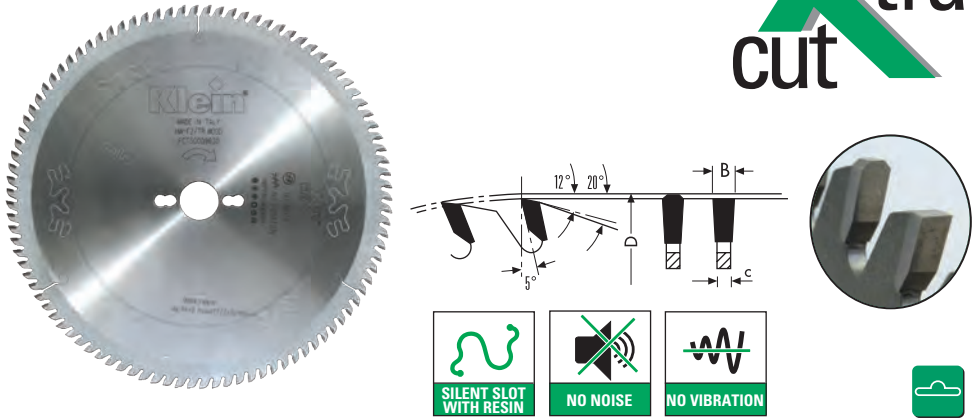

Item	D	d	B	Z	Pin holes
FCT250.06030	250	30	3,2/2,2	60	PH02
FCT250.08030	250	30	3,2/2,2	80	PH02
FCT300.07230	300	30	3,2/2,2	72	PH02
FCT300.09630	300	30	3,2/2,2	96	PH02
FCT350.08430	350	30	3,5/2,5	84	PH02
FCT350.11230	350	30	3,5/2,5	112	PH02

Xtra[®]
cut

MACHINES



USEFUL INFORMATION

- Ideal also for working **ALUCOBOND[®]**, a composite panel consisting of two aluminium cover sheets and a plastic core which can be polyethylene (PE) or mineral core (**ALUCOBOND[®] Plus - A2**)
- Pin holes: **PH02=2/7/42 + 2/9,5/46,5 + 2/10/60**

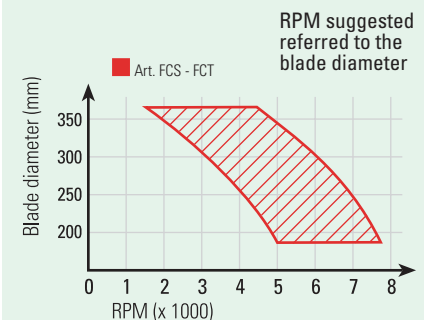
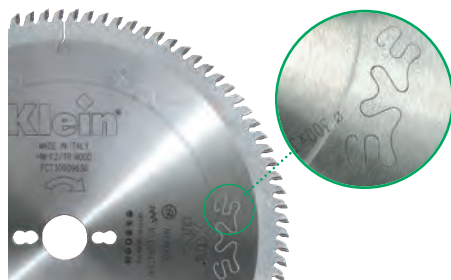

DP SAWBLADES FOR BILAMINATED PANELS

ART. XFC

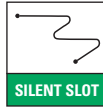
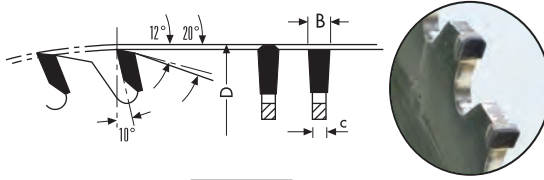

Item	D	d	B/c	Z	Pin holes
XFC250.04830	250	30	3,2/2,2	48	PH02
XFC250.06030	250	30	3,2/2,2	60	PH02
XFC300.06030	300	30	3,2/2,2	60	PH02
XFC300.07230	300	30	3,2/2,2	72	PH02
XFC350.07230	350	30	3,5/2,5	72	PH02
XFC350.08430	350	30	3,5/2,5	84	PH02
XFC350.09630	350	30	3,5/2,5	96	PH02



TEETH FEATURES

- (FZ/TR-TCG) DP triple chip teeth
- Tooth height H= 4 mm

MATERIALS

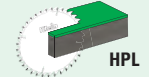
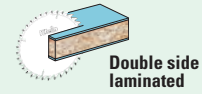
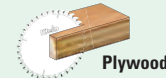
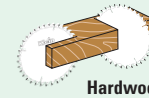

MACHINES



USEFUL INFORMATION

- Pin holes: PH02=2/7/42 + 2/9,5/46,5 + 2/10/60

HW SAWBLADES FOR "SANDWICH" PANELS

ART. MP

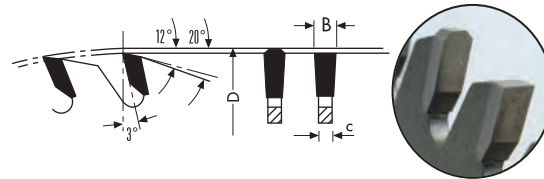

Item	D	d	B/c	Z	Pin holes
MP250.08030	250	30	2,8/2,2	80	
MP300.09630	300	30	2,8/2,2	96	PH01
MP350.10830	350	30	3,2/2,6	108	PH01
MP400.10830	400	30	3,4/2,8	108	PH01
MP500.12040 selling out	500	40	3,8/3,2	120	

TEETH FEATURES

- FZ/TR (TCG) triple chip teeth
- HW grade: SMX (P20 - P25 - C6)

MATERIALS



MACHINES



USEFUL INFORMATION

- Pin holes: PH01= 2/10/60

Some tips for working with multi-ripping saws

A) When operating with a multi-rip saw the use of shoulder saw blades is very important (Items FG).

Positioned as the first blade on the machine side they allow, especially during heavy-duty processing or working uneven timber, that the forces have a proper distribution.

B) The use of rakers is highly recommended to avoid the saw blade rubbing on the wood, causing overheating and friction which can damage the saw blades.

C) If the machine spindle has only one keyway it is highly recommended not to use saw blades having two to avoid any unbalanced coupling.

D) Keyways of the saw blades and machine spindle are best coupled when they have the same dimensions.

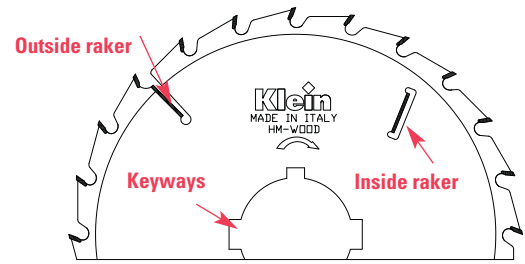

HW MULTIRIP SAWBLADES WITHOUT RAKERS

ART. FE

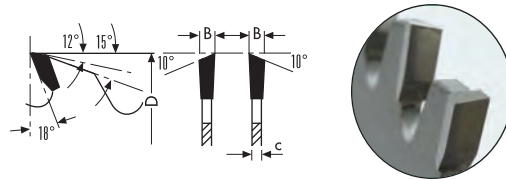

Item	D	d+keyways	B/c	Z
FE300.02870	300	70+ch (21x84)	3,2/2,2	24

TEETH FEATURES

- WZ (ATB) alternate top bevel teeth
- HW grade: KCR10

MATERIALS



MACHINES



Multi-rip

USEFUL INFORMATION

HW SHOULDER RIP SAWBLADES WITH RAKERS

ART. FG

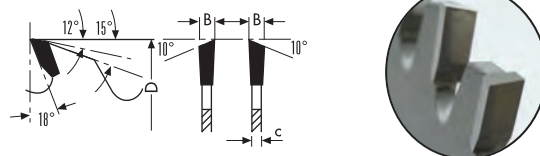

Item	D	d+keyways	B/c	Z	L max
FG300.02470	300	70+ch (21x84)	4,0/2,8	24+2+2	80
FG300.02480	300	80+ch (13x90)	4,0/2,8	24+2+2	80
FG301.02470	300	70+ch (21x84)	5,2/3,6	24+2+2	80
FG301.02475	300	75+ch (21x91)	5,2/3,6	24+2+2	80
FG301.02480	300	80+ch (13x90)	5,2/3,6	24+2+2	80
FG350.02470	350	70+ch (21x84)	4,2/2,8	24+2+4	105
FG350.02475	350	75+ch (21x91)	4,2/2,8	24+2+4	105
FG350.02480	350	80+ch (14x92)	4,2/2,8	24+2+4	105

Lmax= Max cutting length



Shoulder rip blade (Art. FG)

TEETH FEATURES

- WZ (ATB) alternate top bevel teeth
- HW grade: KCR10

MATERIALS



MACHINES



Multi-rip

USEFUL INFORMATION

- With HW rakers for better result in cutting along grain of hard wood and rare wood

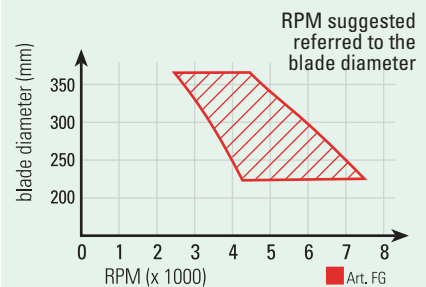

HW MULTIRIP SAWBLADES WITH RAKERS

ART. FH

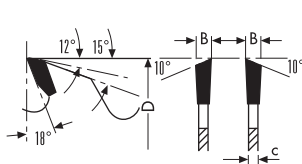

Item	D	d+keyways	B/c	Z	L max
FH250.01830	250	30+PH02	3,2/2,2	20+2+2	65
FH250.01860	250	60+ch (21x74)	3,2/2,2	20+2+2	65
FH250.01870	250	70+ch (21x84)	3,2/2,2	20+2+2	65
FH250.01880	250	80+ch (13x90)	3,2/2,2	20+2+2	65
FH280.02070	280	70+ch (21x84)	3,2/2,2	24+2+2	65
FH280.02080	280	80+ch (13x90)	3,2/2,2	24+2+2	70
FH300.02430	300	30+PH02	3,2/2,2	24+2+2	80
FH300.02460	300	60+ch (21x74)	3,2/2,2	24+2+2	80
FH300.02470	300	70+ch (21x84)	3,2/2,2	24+2+2	80
FH300.02475	300	75+ch (21x91)	3,2/2,2	24+2+2	80
FH300.02480	300	80+ch (13x90)	3,2/2,2	24+2+2	80
FH320.02480	320	80+ch (13x90)	3,2/2,2	24+2+2	90
FH350.02475	350	75+ch (21x91)	3,5/2,5	24+2+4	105
FH350.02480	350	80+ch (14x92)	3,5/2,5	24+2+4	105
FH350.02490	350	90+ch (21x110)	3,5/2,5	24+2+4	95
FH350.02630	350	30+PH02	3,5/2,5	24+2+4	105
FH350.02660	350	60+ch (21x74)	3,5/2,5	24+2+4	105
FH350.02870	350	70+ch (21x84)	3,5/2,5	24+2+4	105
FH400.02875	400	75+ch (21x91)	4,0/2,8	28+2+4	120
FH400.02880	400	80+ch (13x90)	4,0/2,8	28+2+4	120
FH400.03030	400	30+PH02	4,0/2,8	28+2+4	120
FH400.03070	400	70+ch (21x84)	4,0/2,8	28+2+4	120
FH450.02430	450	30	4,6/3,2	24+2+4	135
FH450.02470	450	70+ch (21x84)	4,6/3,2	24+2+4	135
FH450.02475	450	75+ch (21x91)	4,6/3,2	24+2+4	135
FH450.02480	450	80+ch (13x92)	4,6/3,2	24+2+4	135
FH450.02490	450	90+ch (21x110)	4,6/3,2	24+2+4	135
FH500.02630	500	30	4,6/3,2	26+2+6	175

TEETH FEATURES

- WZ (ATB) alternate top bevel teeth
- HW grade: KCR10

MATERIALS



MACHINES



Multi-rip

USEFUL INFORMATION

- With HW outside and inside rakers for better result in cutting
- Pin holes: PH02=2/7/42 + 2/9,5/46,5 + 2/10/60

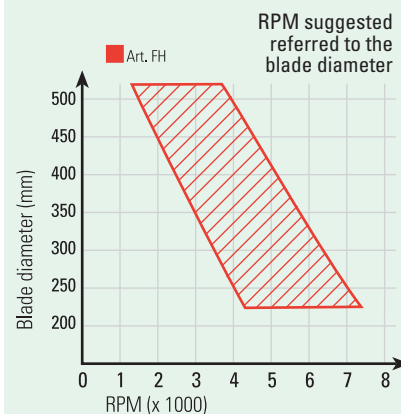

On request we can also supply multirip sawblades for "RAIMANN" machines.

HW MULTIRIP SAWBLADES WITH RAKERS (THIN KERF)

ART. FK

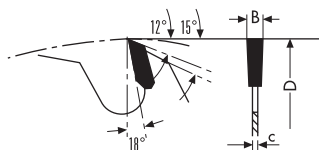

Item	D	d+keyways	B/c	Z	L max
FK180.02140	180	40	2,5/1,8	21+3	30
FK200.02140	200	40	2,5/1,8	21+3	35
FK250.02070	250	70+ch (21x84)	2,7/1,8	20+2+2	50

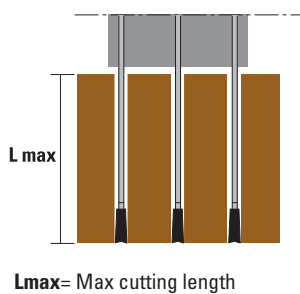

TEETH FEATURES

- FZ flat teeth
- HW grade: KCR10

MATERIALS



MACHINES



Multi-rip

USEFUL INFORMATION

- With HW outside and inside rakers for better result in cutting
- Ideal for processing **wooden floors** and **matchboardings**
- Suitable for ripping where its thin body greatly reduces material wastes

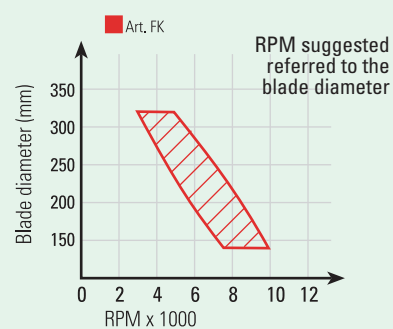

REFERENCE TABLE OF PANEL SIZING MACHINES

ANTHON: MAIN SAWBLADE

Item	D	B	d	Z	MAT.
HCS400.07260	400	4.4/3.2	60+2	72 FZ/TR	HW
HCS450.07260	450	4.4/3.2	60+2	72 FZ/TR	HW

XHC400.07260	400	4.4/3.2	60+2	72 FZ/TR	DP
--------------	-----	---------	------	----------	----

Pin holes 2/11/85

ANTHON: SCORING SAWBLADE

Item	D	B	d	Z	MAT.
FI180.03620	180	4.3/5.5	20	36 KON/FZ	HW

XFI180.03620	180	4.4/5.0	20	36 KON/FZ	DP
XFI182.03620	180	5.8/6.6	20	36 KON/FZ	DP

GABBIANI: MAIN SAWBLADE

Item	D	B	d	Z	MAT.
HCS300.06080	300	4.4/3.2	80+PH4	60 FZ/TR	HW
HCS300.07280	300	4.4/3.2	80+PH4	72 FZ/TR	HW
HCS350.05680	350	4.4/3.2	80+PH4	54 FZ/TR	HW
HCS350.07280	350	4.4/3.2	80+PH4	72 FZ/TR	HW
HCS351.07280	350	4.6/3.2	80+PH4	72 FZ/TR	HW
HCS355.07280	350	4.4/3.2	80+PH4	72 FZ/TR	HW
HCS380.07280	380	4.4/3.2	80+PH4	72 FZ/TR	HW
HCS400.06080	400	4.4/3.2	80+PH4	60 FZ/TR	HW
HCS400.07280	400	4.4/3.2	80+PH4	72 FZ/TR	HW
HCS401.07280	400	4.6/3.2	80+PH4	72 FZ/TR	HW
HCS420.07280	420	4.4/3.2	80+PH4	72 FZ/TR	HW
HCS430.07280	430	4.4/3.2	80+PH4	72 FZ/TR	HW
HCS450.07280	450	4.4/3.2	80+PH4	72 FZ/TR	HW

HBS350.05680	350	4.4/3.2	80+PH4	54 WZ	HW
HBS350.07280	350	4.4/3.2	80+PH4	72 WZ	HW
HBS400.03680	400	4.4/3.2	80+PH4	36 WZ	HW
HBS400.07280	400	4.4/3.2	80+PH4	72 WZ	HW
HBS450.05480	450	4.4/3.2	80+PH4	54 WZ	HW

XHC350.07280	350	4.4/3.2	80+PH4	72 FZ/TR	DP
XHC400.07280	400	4.4/3.2	80+PH4	72 FZ/TR	DP
XHC450.07280	450	4.4/3.2	80+PH4	72 FZ/TR	DP

Pin holes 2/14/110+2/7/110+4/9/100

GABBIANI: SCORING SAWBLADE

Item	D	B	d	Z	MAT.
FI161.03655	160	4.3/5.5	55+3	36 KON/FZ	HW
FI162.03655	160	4.5/5.7	55+3	36 KON/FZ	HW
FI163.03655	160	4.7/6.0	55+3	36 KON/FZ	HW
FI200.03680	200	4.3/5.5	80	36 KON/FZ	HW

Pin holes 2/14/110

XFI160.03655	160	4.4/5.0	55+3	36 KON/FZ	DP
--------------	-----	---------	------	-----------	----

Pin holes 3/7/66

GIBEN: MAIN SAWBLADE

Item	D	B	d	Z	MAT.
HCS330.06050	330	4.4/3.2	50+8	60 FZ/TR	HW
HCS350.07250	350	4.4/3.2	50+8	72 FZ/TR	HW
HCS380.07250	380	4.4/3.2	50+8	72 FZ/TR	HW

XHC320.06050	320	4.4/3.2	50+8	60 FZ/TR	DP
XHC330.06050	330	4.4/3.2	50+8	60 FZ/TR	DP
XHC350.07250	350	4.4/3.2	50+8	72 FZ/TR	DP
XHC360.07250	360	4.4/3.2	50+8	72 FZ/TR	DP

Pin holes 6/12.5/80+2/12.5/80

HCS320.07275	320	4.4/3.2	75+3	72 FZ/TR	HW
--------------	-----	---------	------	----------	----

Pin holes 3/13/95

HCS350.05675	350	4.4/3.2	75+PH5	54 FZ/TR	HW
HCS350.07275	350	4.4/3.2	75+PH5	72 FZ/TR	HW
HCS355.07275	355	4.4/3.2	75+PH5	72 FZ/TR	HW
HCS400.06075	400	4.4/3.2	75+4	60 FZ/TR	HW
HCS400.07275	400	4.4/3.2	75+4	72 FZ/TR	HW
HCS430.07275	430	4.4/3.2	75+4	72 FZ/TR	HW
HCS430.09675	430	4.4/3.2	75+4	96 FZ/TR	HW

HBS350.05675	350	4.4/3.2	75+PH5	54 WZ	HW
HBS400.06075	400	4.4/3.2	75+4	60 WZ	HW
HBS400.07275	400	4.4/3.2	75+4	72 WZ	HW

XHC350.07275	350	4.4/3.2	75+4	72 FZ/TR	DP
XHC400.07275	400	4.4/3.2	75+4	72 FZ/TR	DP
XHC430.07275	430	4.4/3.2	75+4	72 FZ/TR	DP
XHC470.07275	470	4.4/3.2	75+4	72 FZ/TR	DP

Pin holes 4/15/105

GIBEN: SCORING SAWBLADE

Item	D	B	d	Z	MAT.
FL127.02045	125	4.0/4.8	45	20+20 KON/FZ	HW
FI126.02445	125	4.3/5.5	45	24 KON/FZ	HW
XFI126.02045	125	4.0/4.8	45	20+20 KON/FZ	DP
FI161.03645	160	4.3/5.5	45+3	36 KON/FZ	HW
FI162.03645	160	4.5/5.7	45+3	36 KON/FZ	HW

XFI160.03645	160	4.4/5.0	45+3	36 KON/FZ	DP
--------------	-----	---------	------	-----------	----

Pin holes 3/11/70

FI180.03650	180	4.3/5.5	50+3	44 KON/FZ	HW
-------------	-----	---------	------	-----------	----

XFI180.04450	180	4.4/5.0	50+3	44 KON/FZ	DP
--------------	-----	---------	------	-----------	----

Pin holes 3/12.5/80

FI182.03655	180	5.0/6.2	55	36 KON/FZ	HW
-------------	-----	---------	----	-----------	----

FI215.04250	215	4.3/5.5	50+3	42 KON/FZ	HW
FI216.04250	215	4.5/5.7	50+3	42 KON/FZ	HW
FI300.04850	300	4.3/5.5	50+3	48 KON/FZ	HW
FI301.04850	300	4.5/5.7	50+3	48 KON/FZ	HW

XFI215.04250	215	4.4/5.0	50+3	42 KON/FZ	DP
--------------	-----	---------	------	-----------	----

Pin holes 3/15/80

HOLZMA: MAIN SAWBLADE

Item	D	B	d	Z	MAT.
HCS350.07260	350	4.4/3.2	60+2	72 FZ/TR	HW
HCS350.07265	350	4.4/3.2	65	72 FZ/TR	HW
HCS380.07260	380	4.4/3.2	60+2	72 FZ/TR	HW
HCS381.07260	380	4.8/3.5	60+2	72 FZ/TR	HW

XHC350.07260	350	4.4/3.2	60+2	72 FZ/TR	DP
XHC380.07260	380	4.8/3.5	60+2	72 FZ/TR	DP

Pin holes 2/14/100

HCS450.07260	450	4.4/3.2	60+2	72 FZ/TR	HW
HCS452.07260	450	4.8/3.5	60+2	72 FZ/TR	HW

XHC420.07260	420	4.8/3.5	60+2	72 FZ/TR	DP
XHC451.07260	450	4.8/3.5	60+2	72 FZ/TR	DP

Pin holes 2/14/125

XHC500.07260	500	4.8/3.5	60+2	72 FZ/TR	DP
--------------	-----	---------	------	----------	----

Pin holes 2/11/115

XHC481.07260	480	4.8/3.5	60+4	72 FZ/TR	DP
--------------	-----	---------	------	----------	----

Pin holes 2/11/115+2/19/120

HOLZMA: SCORING SAWBLADE

Item	D	B	d	Z	MAT.
FI180.03645	180	4.3/5.5	45	36 KON/FZ	HW
FI181.03645	180	4.7/6.0	45	36 KON/FZ	HW
FI200.03645	200	4.3/5.5	45	36 KON/FZ	HW
FI201.03645	200	4.7/6.0	45	36 KON/FZ	HW
FI204.03645	200	5.8/7.0	45	36 KON/FZ	HW

XFI180.03645	180	4.4/5.0	45	36 KON/FZ	DP
XFI181.03645	180	4.8/5.6	45	36 KON/FZ	DP
XFI200.03645	200	4.4/5.0	45	36 KON/FZ	DP
XFI201.03645	200	4.8/5.6	45	36 KON/FZ	DP
XFI203.03645	200	5.8/6.6	45	36 KON/FZ	DP

HOMAG: MAIN SAWBLADE

Item	D	B	d	Z	MAT.
HCS350.05675	350	4.4/3.2	75	54 FZ/TR	HW
HCS350.07275	350	4.4/3.2	75	72 FZ/TR	HW
HCS355.07275	355	4.4/3.2	75	72 FZ/TR	HW
HCS400.06075	400	4.4/3.2	75	60 FZ/TR	HW
HCS400.07275	400	4.4/3.2	75	72 FZ/TR	HW

HBS350.05675	350	4.4/3.2	75	54 WZ	HW
HBS350.07275	350	4.4/3.2	75	72 WZ	HW
HBS400.07275	400	4.4/3.2	75	72 WZ	HW

XHC350.07275	350	4.4/3.2	75	72 FZ/TR	DP
XHC400.07275	400	4.4/3.2	75	72 FZ/TR	DP

HOMAG: SCORING SAWBLADE

Item	D	B	d	Z	MAT.
FI126.02445	125	4.3/5.5	45	24 KON/FZ	HW
FI151.03645	150	4.3/5.5	45	36 KON/FZ	HW
FI180.03645	180	4.3/5.5	45	36 KON/FZ	HW
FI200.03645	200	4.3/5.5	45	36 KON/FZ	HW

XFI160.03645	160	4.4/5.0	45	36 KON/FZ	DP
XFI180.03645	180	4.4/5.0	45	36 KON/FZ	DP
XFI200.03645	200	4.4/5.0	45	36 KON/FZ	DP

MACMAZZA: MAIN SAWBLADE

Item	D	B	d	Z	MAT.
HCS350.05675	350	4.4/3.2	75+3	54 FZ/TR	HW
HCS350.07275	350	4.4/3.2	75+3	72 FZ/TR	HW
HCS355.07275	355	4.4/3.2	75+3	72 FZ/TR	HW
HCS380.07275	380	4.4/3.2	75+3	72 FZ/TR	HW

HBS350.05675	350	4.4/3.2	75+3	54 WZ	HW
--------------	-----	---------	------	-------	----

XHC350.07275	350	4.4/3.2	75+3	72 FZ/TR	DP
--------------	-----	---------	------	----------	----

Pin holes 3/7/100

HCS450.07275	450	4.4/3.2	75+3	72 FZ/TR	HW
--------------	-----	---------	------	----------	----

Pin holes 3/7/120

MACMAZZA: SCORING SAWBLADE

Articolo	D	B	d	Z	MAT.
FI161.03655	160	4.3/5.5	55+3	36 KON/FZ	HW
FI280.04855	280	4.5/5.6	55+3	48 KON/FZ	HW

XFI160.03645	160	4.4/5.0	55+3	36 KON/FZ	DP
--------------	-----	---------	------	-----------	----

Pin holes 3/6/84

MAYER: MAIN SAWBLADE

Item	D	B	d	Z	MAT.
HCS300.06030	300	4.4/3.2	30+PH1	60 FZ/TR	HW
HCS300.07230	300	4.4/3.2	30+PH1	72 FZ/TR	HW
HCS350.05630	350	4.4/3.2	30+PH1	54 FZ/TR	HW
HCS350.07230	350	4.4/3.2	30+PH1	72 FZ/TR	HW
HCS400.06030	400	4.4/3.2	30+2	60 FZ/TR	HW
HCS400.07230	400	4.4/3.2	30+2	72 FZ/TR	HW
HBS300.04830	300	4.4/3.2	30+PH1	48A	HW
HBS300.06030	300	4.4/3.2	30+PH1	60A	HW
HBS350.05430	350	4.4/3.2	30+PH1	54A	HW
HBS400.06030	400	4.4/3.2	30+2	60A	HW
HBS400.07230	400	4.4/3.2	30+2	72A	HW
XHC300.06030	300	4.4/3.2	30+PH1	60 FZ/TR	DP
XHC350.07230	350	4.4/3.2	30+PH1	72 FZ/TR	DP
XHC400.07230	400	4.4/3.2	30+2	72 FZ/TR	DP

Pin holes 2/10/60

MAYER: SCORING SAWBLADE

Item	D	B	d	Z	MAT.
FL127.02045	125	4.0/4.8	45	20+20 KON/FZ	HW
FI126.02445	125	4.3/5.5	45	24 KON/FZ	HW
FI151.03630	150	4.3/5.5	30	36 KON/FZ	HW
XFI126.02045	125	4.0/4.8	45	20+20 KON/FZ	DP

PANHANS: MAIN SAWBLADE

Item	D	B	d	Z	MAT.
HCS300.06030	300	4.4/3.2	30+PH1	60 FZ/TR	HW
HCS300.07230	300	4.4/3.2	30+PH1	72 FZ/TR	HW
HCS350.05430	350	4.4/3.2	30+PH1	54 FZ/TR	HW
HCS350.07230	350	4.4/3.2	30+PH1	72 FZ/TR	HW
HCS400.06030	400	4.4/3.2	30+PH1	60 FZ/TR	HW
HCS400.07230	400	4.4/3.2	30+PH1	72 FZ/TR	HW
HCS450.07230	450	4.4/3.2	30+2	72 FZ/TR	HW
HBS300.04830	300	4.4/3.2	30+PH1	48 WZ	HW
HBS300.06030	300	4.4/3.2	30+PH1	60 WZ	HW
HBS300.07230	300	4.4/3.2	30+PH1	72 WZ	HW
HBS350.05430	350	4.4/3.2	30+PH1	54 WZ	HW
HBS400.06030	400	4.4/3.2	30+2	60 WZ	HW
HBS400.07230	400	4.4/3.2	30+2	72 WZ	HW
HBS450.07230	450	4.4/3.2	30+2	72 WZ	HW
XHC300.06030	300	4.4/3.2	30+PH1	60 FZ/TR	DP
XHC350.07230	350	4.4/3.2	30+PH1	72 FZ/TR	DP
XHC400.07230	400	4.4/3.2	30+2	72 FZ/TR	DP

Pin holes 2/10/60

PANHANS: SCORING SAWBLADE

Item	D	B	d	Z	MAT.
FI126.02420	125	4.3/5.5	20	24 KON/FZ	HW
FI180.03630	180	4.3/5.5	30	36 KON/FZ	HW
FI200.03630	200	4.3/5.5	30	36 KON/FZ	HW
XFI200.03630	200	4.4/5.0	30	36 KON/FZ	DP

SCHELLING: MAIN SAWBLADE

Item	D	B	d	Z	MAT.
HCS300.07230	300	4.4/3.2	30+PH2	72 FZ/TR	HW
HCS350.05630	350	4.4/3.2	30+PH1	54 FZ/TR	HW
HCS350.07230	350	4.4/3.2	30+PH1	72 FZ/TR	HW
HCS370.07230	370	4.4/3.2	30+2	72 FZ/TR	HW
HCS400.06030	400	4.4/3.2	30+PH1	60 FZ/TR	HW
HCS400.07230	400	4.4/3.2	30+PH1	72 FZ/TR	HW
HBS350.05430	350	4.4/3.2	30+PH1	54 WZ	HW
HBS400.06030	400	4.4/3.2	30+2	60 WZ	HW
HBS400.07230	400	4.4/3.2	30+2	72 WZ	HW
XHC300.06030	300	4.4/3.2	30+PH1	60 FZ/TR	DP
XHC350.07230	350	4.4/3.2	30+PH1	72 FZ/TR	DP
XHC370.07230	370	4.4/3.2	30+2	72 FZ/TR	DP
XHC400.07230	400	4.4/3.2	30+2	72 FZ/TR	DP

Pin holes 2/10/60

HCS450.07230	450	4.4/3.2	30+2	72 FZ/TR	HW
HBS500.07230	500	4.6/3.2	30+2	72 WZ	HW
XHC450.07230	450	4.4/3.2	30+2	72 FZ/TR	DP
XHC460.07230	460	4.4/3.2	30+2	72 FZ/TR	DP
XHC480.07230	480	4.4/3.2	30+2	72 FZ/TR	DP

Pin holes 2/13/94

SCHELLING: SCORING SAWBLADE

Item	D	B	d	Z	MAT.
FI180.03630	180	4.3/5.5	30	36 KON/FZ	HW
FI200.03620	200	4.3/5.5	20	36 KON/FZ	HW
FI203.03620	200	5.0/6.2	20	36 KON/FZ	HW
XFI180.03620	180	4.4/5.0	20	36 KON/FZ	DP
XFI200.03620	200	4.4/5.0	20	36 KON/FZ	DP
XFI201.03620	200	5.0/5.8	20	36 KON/FZ	DP

SCM: MAIN SAWBLADE

Item	D	B	d	Z	MAT.
HCS300.06080	300	4.4/3.2	80+PH4	60 FZ/TR	HW
HCS300.07280	300	4.4/3.2	80+PH4	72 FZ/TR	HW
HCS350.05680	350	4.4/3.2	80+PH4	54 FZ/TR	HW
HCS350.07280	350	4.4/3.2	80+PH4	72 FZ/TR	HW
HCS351.07280	350	4.6/3.2	80+PH4	72 FZ/TR	HW
HCS355.07280	355	4.4/3.2	80+PH4	72 FZ/TR	HW
HCS380.07280	380	4.4/3.2	80+PH4	72 FZ/TR	HW
HCS400.06080	400	4.4/3.2	80+PH4	60 FZ/TR	HW
HCS400.07280	400	4.4/3.2	80+PH4	72 FZ/TR	HW
HCS401.07280	400	4.6/3.2	80+PH4	72 FZ/TR	HW
HBS350.05680	350	4.4/3.2	80+PH4	54 WZ	HW
HBS400.03680	400	4.4/3.2	80+PH4	36 WZ	HW
HBS400.04880	400	4.4/3.2	80+PH4	48 WZ	HW
HBS400.07280	400	4.4/3.2	80+PH4	72 WZ	HW

XHC350.07280	350	4.4/3.2	80+PH4	72 FZ/TR	DP
XHC400.07280	400	4.4/3.2	80+PH4	72 FZ/TR	DP
XHC450.07280	450	4.4/3.2	80+PH4	72 FZ/TR	DP

Pin holes 2/14/110+2/7/110+4/9/100

SCM: MAIN SAWBLADE

Item	D	B	d	Z	MAT.
F1161.03655	160	4.3/5.5	55+3	36 KON/FZ	HW
F1162.03655	160	4.5/5.7	55+3	36 KON/FZ	HW

XFI160.03645	160	4.4/5.0	55+3	36 KON/FZ	DP
--------------	-----	---------	------	-----------	----

Pin holes 3/7/66

NANXING: MAIN SAWBLADE

Item	D	B	d	Z	MAT.
HCS350.07260	350	4.4/3.2	60	72 FZ/TR	HW
HCS380.07260	380	4.4/3.2	60	72 FZ/TR	HW

HCS452.07260	450	4.8/3.5	60	72 FZ/TR	HW
--------------	-----	---------	----	----------	----

NANXING: SCORING SAWBLADE

Item	D	B	d	Z	MAT.
F1180.03630	180	4.3/5.5	30+PH1	36 KON/FZ	HW
F1181.03645	180	4.7/6.0	45	36 KON/FZ	HW

F1200.03645	200	4.3/5.5	45	36 KON/FZ	HW
-------------	-----	---------	----	-----------	----

SELCO: MAIN SAWBLADE

Item	D	B	d	Z	MAT.
HCS300.06065	300	4.4/3.2	65+4	60 FZ/TR	HW
HCS300.07265	300	4.4/3.2	65+4	72 FZ/TR	HW
HCS320.06065	320	4.4/3.2	65+4	60 FZ/TR	HW
HCS320.07265	320	4.4/3.2	65	72 FZ/TR	HW
HCS350.07265	350	4.4/3.2	65+4	72 FZ/TR	HW
HCS355.07265	355	4.4/3.2	65	72 FZ/TR	HW
HCS361.07265	360	4.6/3.2	65+4	72 FZ/TR	HW
HCS380.07265	380	4.4/3.2	65	72 FZ/TR	HW

XHC300.06065	300	4.4/3.2	65+4	60 FZ/TR	DP
XHC320.06065	320	4.4/3.2	65+4	60 FZ/TR	DP
XHC350.07265	350	4.4/3.2	65+4	72 FZ/TR	DP
XHC360.07265	360	4.4/3.2	65+4	72 FZ/TR	DP

Pin holes 2/9/100+2/9/110

HCS350.05680	350	4.4/3.2	80+PH4	54 FZ/TR	HW
HCS350.07280	350	4.4/3.2	80+PH4	72 FZ/TR	HW
HCS351.07280	350	4.6/3.2	80+PH4	72 FZ/TR	HW
HCS355.07280	355	4.4/3.2	80+PH4	72 FZ/TR	HW
HCS400.06080	400	4.4/3.2	80+PH4	60 FZ/TR	HW
HCS400.07280	400	4.4/3.2	80+PH4	72 FZ/TR	HW
HCS401.07280	400	4.6/3.2	80+PH4	72 FZ/TR	HW
HCS430.07280	430	4.4/3.2	80+PH4	72 FZ/TR	HW
HCS450.07280	450	4.4/3.2	80+PH4	72 FZ/TR	HW
HCS452.07280	450	4.8/3.5	80+PH4	72 FZ/TR	HW
HCS520.07270	520	4.8/3.5	70	72 FZ/TR	HW

HBS350.05480	350	4.4/3.2	80+PH4	54 WZ	HW
HBS400.03680	400	4.4/3.2	80+PH4	36 WZ	HW
HBS400.04880	400	4.4/3.2	80+PH4	48 WZ	HW
HBS400.07280	400	4.4/3.2	80+PH4	72 WZ	HW
HBS451.04880	450	4.8/3.5	80+PH4	48 WZ	HW

XHC350.07280	350	4.4/3.2	80+PH4	72 FZ/TR	DP
XHC400.07280	400	4.4/3.2	80+PH4	72 FZ/TR	DP
XHC430.07280	430	4.4/3.2	80+PH4	72 FZ/TR	DP
XHC450.07280	450	4.4/3.2	80+PH4	72 FZ/TR	DP
XHC451.07280	450	4.8/3.5	80+PH4	72 FZ/TR	DP
XHC481.07280	480	4.8/3.5	80+6	72 FZ/TR	DP

Pin holes 4/19/120+2/9/130

SELCO: SCORING SAWBLADE

Item	D	B	d	Z	MAT.
F1200.03665	200	4.3/5.5	65+4	36 KON/FZ	HW
F1201.03665	200	4.7/6.0	65+4	36 KON/FZ	HW
F1202.03665	200	4.5/5.7	65+4	36 KON/FZ	HW
F1300.07265	300	4.3/5.5	65+4	72 KON/FZ	HW
F1301.07265	300	4.5/5.7	65+4	72 KON/FZ	HW
F1302.07265	300	4.7/6.0	65+4	72 KON/FZ	HW

XFI200.03665	200	4.4/5.0	65+4	36 KON/FZ	DP
XFI200.03645	200	4.8/5.6	65+4	36 KON/FZ	DP

Pin holes 2/9/100+2/9/110

HW CONICAL SCORING SAWBLADES

ART. FI

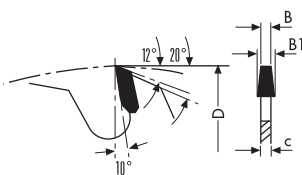

Item	D	d	B-B1/c	Z	Machine
FI080.01220	80	20	3,1-4,0/2,2	12	Casadei
FI100.02020	100	20	3,1-4,3/2,2	20	
FI100.02022	100	22	3,1-4,3/2,2	20	
FI110.02020	110	20	3,1-4,3/2,2	20	
FI120.02420	120	20	3,1-4,3/2,2	20	
FI120.02422	120	22	3,1-4,3/2,2	20	
FI121.02445 selling out	120	45	4,3-5,5/2,8	24	
FI122.02020	120	20	3,4-4,5/2,2	20	SCM
FI125.02420	125	20	3,1-4,3/2,2	24	Panhans-Schelling
FI125.02445	125	45	3,1-4,3/2,2	24	
FI126.02420	125	20	4,3-5,5/3,2	24	Panhans-Gabbiani
FI126.02422 selling out	125	22	4,3-5,5/3,2	24	
FI126.02445	125	45	4,3-5,5/3,2	24	Giben-Homag
FI127.02420	125	20	3,4-4,5/2,2	24	
FI127.02430 selling out	125	30	3,4-4,5/2,2	24	
FI150.03630	150	30	3,4-4,5/2,2	36	SCM
FI150.03650 selling out	150	50	3,4-4,5/2,2	36	
FI151.02430	150	30	4,3-5,5/3,2	24	
FI151.03630	150	30	4,3-5,5/3,2	36	SCM-Verry
FI151.03645	150	45	4,3-5,5/3,2	36	Giben-SCM-Holzma-Homag
FI152.03630	150	30	3,9-5,1/2,8	36	
FI153.03630	150	30	3,1-4,3/2,2	36	SCM
FI161.02430	160	30	4,3-5,5/3,2	36	Langzauner
FI161.03620	160	20	4,3-5,5/3,2	36	
FI161.03645	160	45	4,3-5,5/3,2	36	Giben
FI161.03655	160	55	4,3-5,5/3,2	36	MacMazza-Gabbiani-SCM
FI162.03655	160	55	4,5-5,7/3,2	36	Gabbiani
FI180.03620	180	20	4,3-5,5/3,2	36	Schelling-Anthon
FI180.03630	180	30	4,3-5,5/3,2	36	2/10/60
FI180.03650	180	50	4,3-5,5/3,2	44	Giben
FI180.03645	180	45	4,3-5,5/3,2	36	Holzma
FI180.03655	180	55	4,3-5,5/3,2	36	Giben
FI181.03645	180	45	4,7-6,0/3,5	36	Holzma - Nanxing
FI200.03620	200	20	4,3-5,5/3,2	36	Schelling
FI200.03630	200	30	4,3-5,5/3,2	36	Scheer
FI200.03645	200	45	4,3-5,5/3,2	36	Holzma - Nanxing
FI200.03665	200	65	4,3-5,5/3,2	36	Selco
FI200.03680	200	80	4,3-5,5/3,2	36	Gabbiani
FI201.03645	200	45	4,7-6,0/3,5	36	Holzma
FI201.03665	200	65	4,7-6,0/3,5	36	Selco
FI202.03665	200	65	4,5-5,7/3,2	36	Selco
FI204.03645	200	45	5,8-7,0/4,0	36	Holzma
FI215.04250	215	50	4,3-5,5/3,2	42	Giben
FI300.04850	300	50	4,3-5,5/3,2	48	Giben
FI300.07265	300	65	4,3-5,5/3,2	72	Selco
FI301.07265	300	65	4,5-5,7/3,2	72	Selco

TEETH FEATURES

- KON/FZ conical teeth
- HW grade: KCR05+ (K01-C4)

MATERIALS

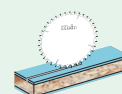

Scoring sawblades for cutting laminated materials

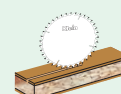

Scoring sawblades for cutting veneer board



Scoring sawblades for cutting MDF

MACHINES



Panel saw



Beam saw

USEFUL INFORMATION

- To be used on panel sizing machines that allow the vertical adjustment of the scorer in relation to the panel sizing sawblade.

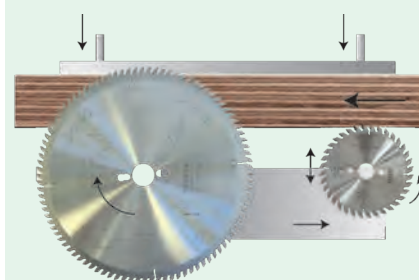

DP CONICAL SCORING SAWBLADES

ART. XFI

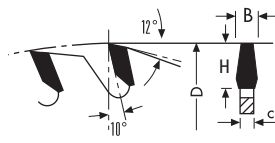

UP TO
30/50X
TOOL LIFE



TEETH FEATURES

- (KON/FZ) DP conical teeth
- Tooth height **H= 4 mm**

MATERIALS

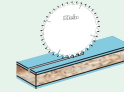

Scoring sawblades
for cutting laminated
materials

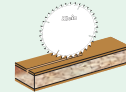

Scoring sawblades
for cutting veneer
board



Scoring sawblades
for cutting MDF

Item	D	d	B/c	Z	Pin holes
XFI120.02020	120	20	3,1-3,7/2,2	20	
XFI120.02022	120	22	3,1-3,7/2,2	20	
XFI125.02420	125	20	3,1-3,7/2,2	20	
XFI125.02422	125	22	3,1-3,7/2,2	20	
XFI160.03645	160	45	4,4-5,0/3,2	36	Giben
XFI160.03655	160	55	4,4-5,0/3,2	36	Gabbiani
XFI180.03620	180	20	4,4-5,0/3,2	36	
XFI180.03645	180	45	4,4-5,0/3,2	36	Holzma
XFI180.04450	180	50	4,4-5,0/3,2	44	Giben
XFI181.03645	180	45	4,8-5,6/3,5	36	Holzma
XFI182.03620	180	20	5,8-6,6/4,0	36	Anthon
XFI200.03620	200	20	4,4-5,0/3,2	36	
XFI200.03630	200	30	4,4-5,0/3,2	36	
XFI200.03645	200	45	4,4-5,0/3,2	36	Holzma
XFI200.03665	200	65	4,4-5,0/3,2	36	Selco
XFI201.03645	200	45	4,8-5,6/3,5	36	Holzma
XFI201.03665	200	65	4,8-5,6/3,5	36	Selco
XFI202.03620	200	20	5,0-5,8/3,5	36	Schelling
XFI203.03645	200	45	5,8-6,6/4,0	36	Holzma
XFI215.04250	215	50	4,4-5,0/3,2	42	Giben

MACHINES



Panel saw



Beam saw

USEFUL INFORMATION

- To be used on panel sizing machines that allow the vertical adjustment of the scorer in relation to the panel sizing sawblade.

HW ADJUSTABLE SCORING SAWBLADES

ART. FL

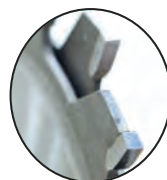
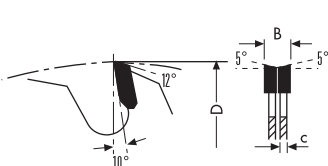

Item	D	d	B/c	Z	Machine
FL080.01020	80	20	2,8-3,6/2,2	10+10	Robland
FL100.01220	100	20	2,8-3,6/2,2	10+10	Schelling-Martin-Panhans
FL100.01222	100	22	2,8-3,6/2,2	10+10	Altendorf-Striebig-Panhans
FL120.01220	120	20	2,8-3,6/2,2	12+12	Holzher-SCM
FL120.01222	120	22	2,8-3,6/2,2	12+12	Altendorf-Martin-Mrozek
FL125.01220	125	20	2,8-3,6/2,2	12+12	Paoloni
FL125.01222	125	22	2,8-3,6/2,2	12+12	

HW adjustable scoring sawblades unit without rings

FL120.01250AN	120	50+4	2,8-3,8/2,2	12+12	
---------------	-----	------	-------------	-------	--

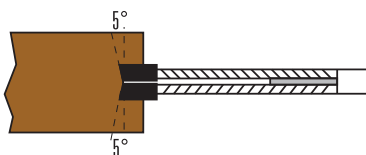

TEETH FEATURES

- LFZ flat teeth
- HW grade: KCR05+ (K01-C4)

MATERIALS

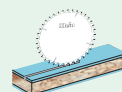

Scoring sawblades for cutting laminated materials

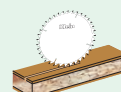

Scoring sawblades for cutting veneer board



Scoring sawblades for cutting MDF

MACHINES



Panel saw



Beam saw

USEFUL INFORMATION

- Split scoring saw blade supplied with spacers
- Part number FL120.01250AN is an adjustable scoring sawblades unit without rings

DP ADJUSTABLE SCORING SAWBLADES

ART. XFL

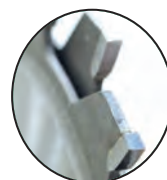
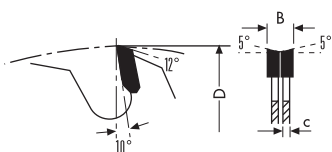

UP TO
30/50X
TOOL LIFE

Item	D	d	B/c	Z
XFL125.01020	125	20	2,8-3,4/2,2	10+10
XFL125.01022	125	22	2,8-3,4/2,2	10+10

TEETH FEATURES

- (LFZ) DP flat teeth
- Tooth Height H=4mm

USEFUL INFORMATION

- Supplied with spacers

HW PANEL SIZING SAWBLADES

ART. HBS

Xtra®
cut

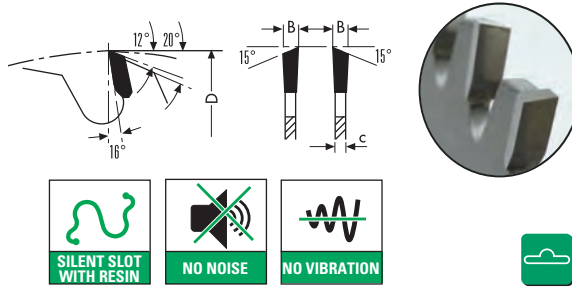

TEETH FEATURES

- WZ (ATB) alternate top bevel teeth
- HW grade: KCR05+ (K01-C4)

MATERIALS

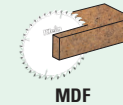
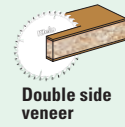
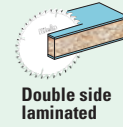

MACHINES



Beam saw

USEFUL INFORMATION

- Pin holes:
PH01= 2/10/60
PH02= 2/7/42 + 2/9,5/46,5 + 2/10/60
PH04= 2/14/110 + 2/7/110 + 4/9/100 + 4/19/120 + 2/9/130 (Selco-Gabbani-SCM)
PH05= 4/15/105 + 3/7/100 (Giben-Homag-MacMazza)

Item	D	d	B/c	Z	Pin holes
HBS300.04830	300	30	4,4/3,2	48	PH02
HBS300.06030	300	30	4,4/3,2	60	PH02
HBS350.05630	350	30	4,4/3,2	54	PH02
HBS350.05675	350	75	4,4/3,2	54	PH05
HBS350.05680	350	80	4,4/3,2	54	PH04
HBS400.03630	400	30	4,4/3,2	36	PH01
HBS400.03680	400	80	4,4/3,2	36	PH04
HBS400.06030	400	30	4,4/3,2	60	PH01
HBS400.07230	400	30	4,4/3,2	72	PH01
HBS400.07275	400	75	4,4/3,2	72	Giben-Homag
HBS400.07280	400	80	4,4/3,2	72	PH04
HBS451.04880 selling out	450	80	4,8/3,5	48	PH04
HBS500.07230	500	30	4,6/3,2	72	PH01 +Schelling

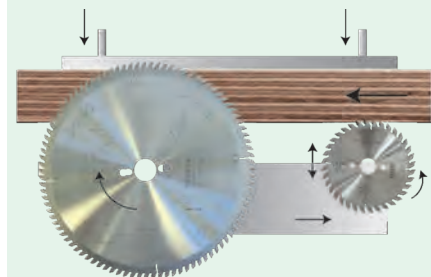

HW PANEL SIZING SAWBLADES

ART. HCS

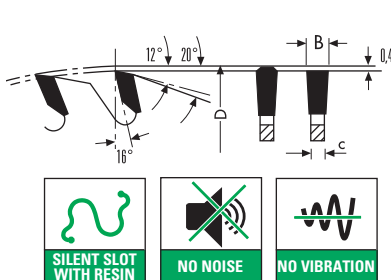

TEETH FEATURES

- FZ/TR (TCG) triple chip teeth
- HW grade: KCR05+ (K01-C4)

MATERIALS

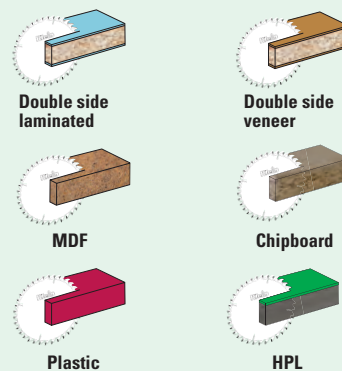

MACHINES



Beam saw

USEFUL INFORMATION

- Pin holes:
PH01= 2/10/60
PH02= 2/7/42 + 2/9,5/46,5 + 2/10/60
PH04= 2/14/110 + 2/7/110 + 4/9/100 + 4/19/120 + 2/9/130 (Selco-Gabbiani-SCM)
PH05= 4/15/105 + 3/7/100 (Giben-Homag-MacMazza)
- Biesse beam saws model for Klein® saw blade code:
 - HCS300.06065 : for panel sizing centres Selco EB70 / EB70L
 - HCS320.06065 : for panel sizing centres Selco EB75 / EB80 / SEKTOR 430 / SEKTOR 450 / SK450
 - HCS320.07265 : for panel sizing centres Selco WN2 / WN230 / SK230
 - HCS350.07265 : for panel sizing centres Selco WN250
 - HCS355.07265 : for panel sizing centres Selco EB95 / SEKTOR 470 / SK470 / SK370
 - HCS355.07280 : for panel sizing centres Selco EB90
 - HCS361.07265 : for panel sizing centres Selco EB100
 - HCS380.07265 : for panel sizing centres Selco WN610 / WNA610
 - HCS400.07280 : for panel sizing centres Selco EB108 / EB110 / EB120 / WN125 / WN200 / WN512 / WN600-132 / WN600-145
 - HCS430.07280 : for panel sizing centres Selco WNA600-162 / WN125
 - HCS452.07280 : for panel sizing centres Selco WNA200 / WN600-132
 - HCS520.07270 : for panel sizing centres Selco WN750 / WNA750

Item	D	d	B/c	Z	Pin holes
HCS300.06030	300	30	4,4/3,2	60	PH02
HCS300.06065	300	65	4,4/3,2	60	Selco
HCS300.06075	300	75	4,4/3,2	60	Homag
HCS300.06080	300	80	4,4/3,2	60	Gabbiani
HCS300.07230	300	30	4,4/3,2	72	PH02
HCS300.07280	300	80	4,4/3,2	72	Gabbiani
HCS320.06065	320	65	4,4/3,2	60	Selco
HCS320.07265	320	65	4,4/3,2	72	Selco
HCS320.07275	320	75	4,4/3,2	72	Giben
HCS330.06050	330	50	4,4/3,2	60	Giben
HCS350.05630	350	30	4,4/3,2	54	PH02
HCS350.05675	350	75	4,4/3,2	54	PH05
HCS350.05680	350	80	4,4/3,2	54	PH04
HCS350.07230	350	30	4,4/3,2	72	PH02
HCS350.07250	350	50	4,4/3,2	72	Giben
HCS350.07260	350	60	4,4/3,2	72	Holzma - Nanxing
HCS350.07265	350	65	4,4/3,2	72	Selco
HCS350.07275	350	75	4,4/3,2	72	PH05
HCS350.07280	350	80	4,4/3,2	72	PH04
HCS351.07280	350	80	4,6/3,2	72	PH04
HCS355.07230	355	30	4,4/3,2	72	PH02
HCS355.07265	355	65	4,4/3,2	72	Selco
HCS355.07275	355	75	4,4/3,2	72	PH05
HCS355.07280	355	80	4,4/3,2	72	PH04
HCS361.07265	360	65	4,6/3,2	72	Selco
HCS370.07230	370	30	4,4/3,2	72	Schelling
HCS380.07250	380	50	4,4/3,2	72	Giben
HCS380.07260	380	60	4,4/3,2	72	Holzma - Nanxing
HCS380.07265	380	65	4,4/3,2	72	Selco
HCS380.07280	380	80	4,4/3,2	72	PH04
HCS381.07260	380	60	4,8/3,5	72	Holzma
HCS400.06030	400	30	4,4/3,2	60	PH01
HCS400.06075	400	75	4,4/3,2	60	Giben-Homag
HCS400.06080	400	80	4,4/3,2	60	PH04
HCS400.07230	400	30	4,4/3,2	72	PH01
HCS400.07260	400	60	4,4/3,2	72	Antho
HCS400.07275	400	75	4,4/3,2	72	Giben-Homag
HCS400.07280	400	80	4,4/3,2	72	PH04
HCS401.07280	400	80	4,6/3,2	72	PH04
HCS420.07280	420	80	4,4/3,2	72	PH04
HCS430.07275	430	75	4,4/3,2	72	Giben
HCS430.07280	430	80	4,4/3,2	72	PH04

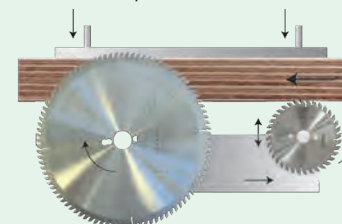

HW PANEL SIZING SAWBLADES

ART. HCS



Item	D	d	B/c	Z	Pin holes
HCS450.07230	450	30	4,4/3,2	72	Schelling
HCS450.07275	450	75	4,4/3,2	72	MacMazza
HCS452.07260	450	60	4,8/3,5	72	Holzma-Nanxing
HCS452.07280	450	80	4,8/3,5	72	PH04
HCS520.07270	520	70	4,8/3,5	72	Selco

Pin holes for sizing sawblades:

PH01

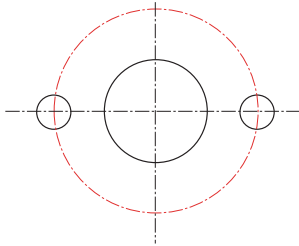

PH02

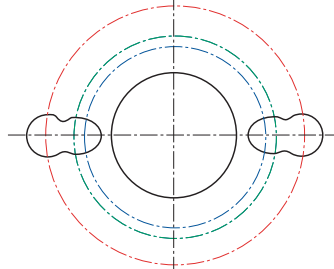

Name	Nr of holes diameter of holes/pitch circle diameter	Machine type
PH01	2/10/60	Universal

Name	Nr of holes diameter of holes/pitch circle diameter	Machine type
PH02	2/7/42 2/9,5/46,5 2/10/60	Universal

PH04

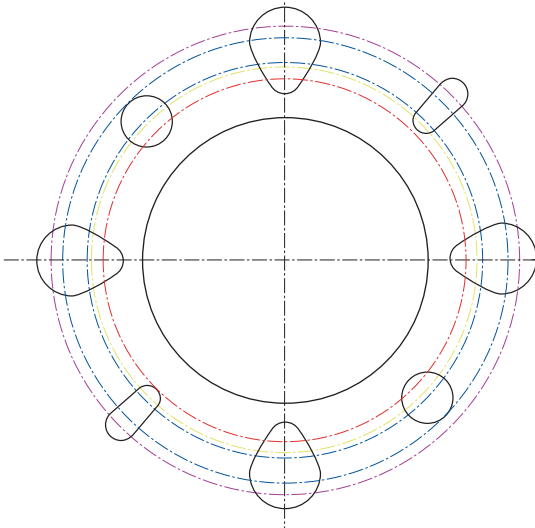

PH05

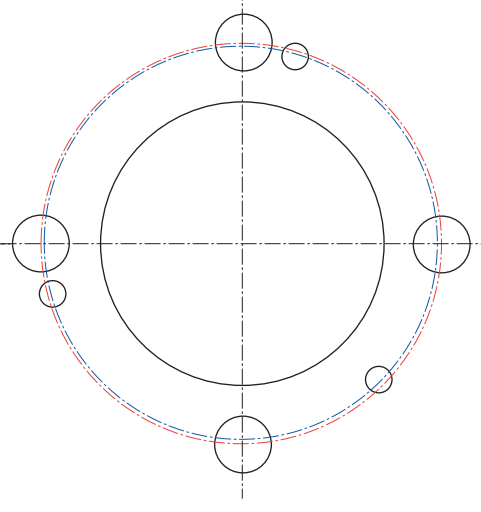

Name	Nr of holes diameter of holes/pitch circle diameter	Machine type
PH04	2/14/110	GABBIANI
	2/7/110	SCM
	4/9/100	SELCO
	4/19/120	
	2/9/130	

Name	Nr of holes diameter of holes/pitch circle diameter	Machine type
PH05	4/15/105 3/7/100	GIBEN HOMAG MACMAZZA

TEETH FEATURES

- FZ/TR (TCG) triple chip teeth
- HW grade: KCR05+ (K01-C4)

MATERIALS

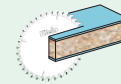

Double side laminated



Double side veneer

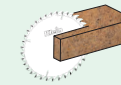

MDF

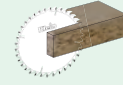

Chipboard

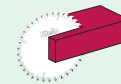

Plastic

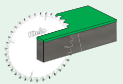

HPL

MACHINES



Beam saw

USEFUL INFORMATION

- Pin holes:
 - PH01**= 2/10/60
 - PH02**= 2/7/42 + 2/9,5/46,5 + 2/10/60
 - PH04**= 2/14/110 + 2/7/110 + 4/9/100 + 4/19/120 + 2/9/130 (Selco-Gabbiani-SCM)
 - PH05**= 4/15/105 + 3/7/100 (Giben-Homag-MacMazza)
- Biesse beam saws model for Klein® saw blade code:
 - HCS300.06065 : for panel sizing centres Selco EB70 / EB70L
 - HCS320.06065 : for panel sizing centres Selco EB75 / EB80 / SEKTOR 430 / SEKTOR 450 / SK450
 - HCS320.07265 : for panel sizing centres Selco WN2 / WN230 / SK230
 - HCS350.07265 : for panel sizing centres Selco WN250
 - HCS355.07265 : for panel sizing centres Selco EB95 / SEKTOR 470 / SK470 / SK370
 - HCS355.07280 : for panel sizing centres Selco EB90
 - HCS361.07265 : for panel sizing centres Selco EB100
 - HCS380.07265 : for panel sizing centres Selco WN610 / WNA610
 - HCS400.07280 : for panel sizing centres Selco EB108 / EB110 / EB120 / WN125 / WN200 / WN512 / WN600-132 / WN600-145
 - HCS430.07280 : for panel sizing centres Selco WNA600-162 / WN125
 - HCS452.07280 : for panel sizing centres Selco WNA200 / WN600-132
 - HCS520.07270 : for panel sizing centres Selco WN750 / WNA750

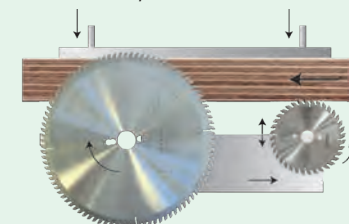

DP PANEL SIZING SAWBLADES

ART. XHC

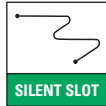
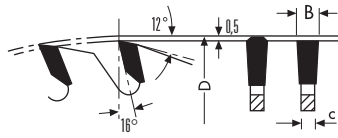

Item	D	d	B/c	Z	Pin holes
XHC300.06030	300	30	4,4/3,2	60	PH02
XHC300.06065	300	65	4,4/3,2	60	Selco
XHC320.06050	320	50	4,4/3,2	60	Giben
XHC320.06065	320	65	4,4/3,2	60	Selco
XHC330.06050	330	50	4,4/3,2	60	Giben
XHC350.07230	350	30	4,4/3,2	72	PH02
XHC350.07250	350	50	4,4/3,2	72	Giben
XHC350.07260	350	60	4,4/3,2	72	Holzma
XHC350.07265	350	65	4,4/3,2	72	Selco
XHC350.07275	350	75	4,4/3,2	72	PH05
XHC350.07280	350	80	4,4/3,2	72	PH04
XHC360.07250	360	50	4,4/3,2	72	Giben
XHC360.07265	360	65	4,4/3,2	72	Selco
XHC370.07230	370	30	4,4/3,2	72	PH02
XHC380.07260	380	60	4,8/3,5	72	Holzma
XHC400.07230	400	30	4,4/3,2	72	2/10/60
XHC400.07260	400	60	4,4/3,2	72	Anthon
XHC400.07275	400	75	4,4/3,2	72	Giben-Homag
XHC400.07280	400	80	4,4/3,2	72	PH04
XHC401.07260	400	60	4,8/3,5	72	Holzma
XHC420.07260	420	60	4,8/3,5	72	Holzma
XHC430.07275	430	75	4,8/3,5	72	Giben
XHC430.07280	430	80	4,8/3,5	72	PH04
XHC450.07230	450	30	4,4/3,2	72	Schelling
XHC450.07280	450	80	4,4/3,2	72	PH04
XHC451.07260	450	60	4,8/3,5	72	Holzma
XHC451.07280	450	80	4,8/3,5	72	PH04
XHC460.07230	460	30	4,4/3,2	72	Schelling
XHC470.07275	470	75	4,4/3,2	72	Giben
XHC480.07230	480	30	4,4/3,2	72	Schelling
XHC481.07260	480	60	4,8/3,5	72	Holzma
XHC481.07280	480	80	4,8/3,5	72	Selco
XHC500.07260	500	60	4,8/3,5	72	Holzma
XHC520.07260	520	60	4,8/3,5	60	Holzma

TEETH FEATURES

- FZ/TR (TCG) DP triple chip teeth
- Tooth height H= 4 mm (can be produced also with H= 5/6 mm)

MATERIALS

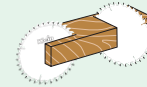

Hardwood



Softwood

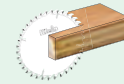

Plywood

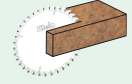

MDF

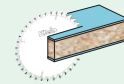

Double side laminated

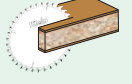

Double side veneer

MACHINES



Beam saw

USEFUL INFORMATION

- Pin holes:
PH02= 2/7/42 + 2/9,5/46,5 + 2/10/60
PH04= 2/14/110 + 2/7/110 + 4/9/100 + 4/19/120 + 2/9/130 (Selco-Gabbiani-SCM)
PH05= 4/15/105 + 3/7/100 (Giben-Homag-MacMazza)

HW SCORING SAWBLADES FOR EDGE BANDING AND SQUARING MACHINES

ART. FM

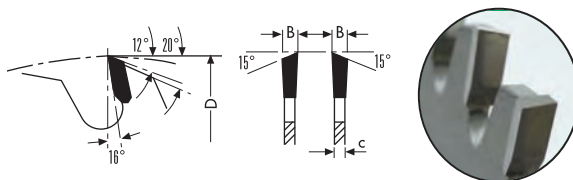

Item	D	d	B/c	Z
FM100.02020	100	20	3,2/2,2	20
FM115.02430	115	30	2,6/1,8	24
FM120.03020	120	20	3,2/2,2	30
FM125.02020	125	20	3,2/2,2	24
FM160.04830	160	30	3,2/2,2	48

HW SCORING SAWBLADES FOR EDGE BANDING AND SQUARING MACHINES (for Art. FP)

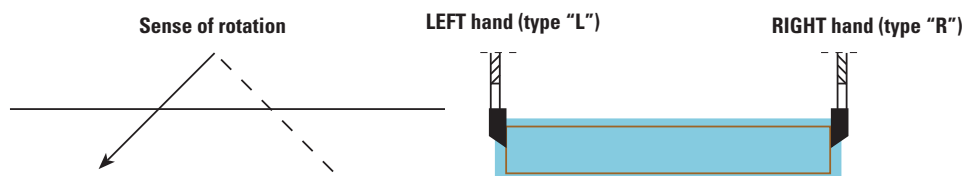

HW SCORING SAWBLADES FOR EDGE BANDING AND SQUARING MACHINES

ART. FP

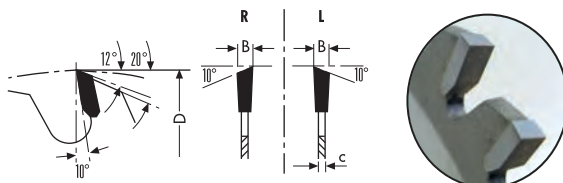

Item	D	d	B/c	Z
FP100.02020R	100	20	3,2/2,2	20
FP100.02020L	100	20	3,2/2,2	20
FP115.02430R	115	30 Stefani	2,6/1,8	24
FP115.02430L	115	30 Stefani	2,6/1,8	24
FP125.03020R	125	20	3,2/2,2	30
FP125.03020L	125	20	3,2/2,2	30
FP150.03630R	150	30	3,2/2,2	36
FP150.03630L	150	30	3,2/2,2	36

TEETH FEATURES

- WZ (ATB) alternate top bevel teeth
- HW grade: KCR05+ (K01-C4)

MATERIALS

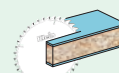

Double side laminated



Double side veneer



MDF

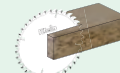

Chipboard

MACHINES



Panel saw

USEFUL INFORMATION

TEETH FEATURES

- ES 1 sided top bevel teeth
- R= right hand
- L= left hand
- HW grade: KCR05+ (K01-C4)

MATERIALS

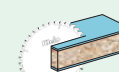

Double side laminated



Double side veneer



MDF

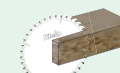

Chipboard

MACHINES



Panel saw

HW SAWBLADES FOR CNC MACHINING CENTRES

ART. FR

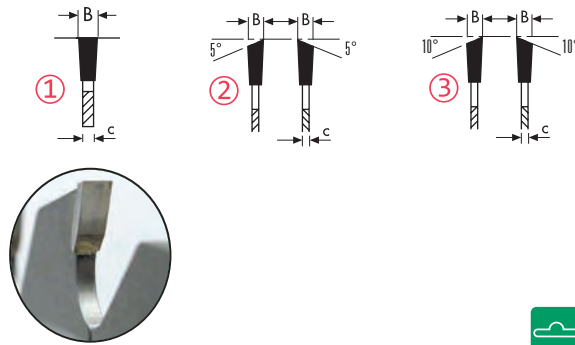

Item	D	d	B/c	Z	Draw.	P. holes
FR120.03035	120	35	4,0/2,8	30	1	Biesse 6 holes
FR125.03630	125	30	3,2/2,2	36	2	Homag 8 holes
FR126.02430	125	30	4,0/3,0	24	3	Homag 8 holes
FR140.03630	140	30	3,6/2,4	36	2	Biesse 6 holes
FR150.03035	150	35	4,0/3,0	30	1	Biesse 2 holes
FR180.05430	180	30	3,2/2,2	54	2	Homag 4 holes
FR180.04235	180	35	4,0/2,8	42	2	Biesse 8 holes
FR240.03440	240	40	3,2/2,2	34	2	Homag 8 holes
FR300.02450	300	50	3,2/2,2	24	2	Biesse 7 holes

TEETH FEATURES

- 1) FZ flat teeth
- 2) WZ (ATB) alternate top bevel teeth 5°
- 3) WZ (ATB) alternate top bevel teeth 10°
- HW grade: KCR05+ (K01-C4)

MATERIALS

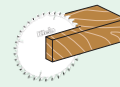

Hardwood

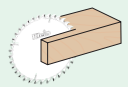

Softwood

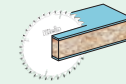

Single side laminate

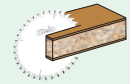

Single side veneer

MACHINES



CNC machining centres

USEFUL INFORMATION

- Available with three different types of teeth (as per drawings)

HW SAWBLADES FOR OPTIMIZING CROSSCUT SAW MACHINE

ART. MRS

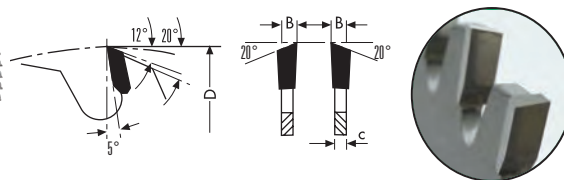

Item	D	d	B/c	Z	Pin holes
MRS400.12030	400	30	4,6/3,5	120	2/10/60
MRS450.13230	450	30	4,6/3,5	132	2/10/60 + 2/15/63
MRS500.14430	500	30	4,6/3,5	144	2/10/60 + 2/15/63

TEETH FEATURES

- WZ (ATB) alternate top bevel teeth
- HW grade: KCR05+ (K01-C4)

MATERIALS

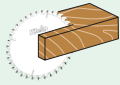

Hardwood

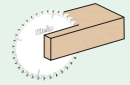

Softwood

MACHINES



Panel saw



CNC machining centres



Optimizing cross cut

USEFUL INFORMATION

- Suitable for optimizing cross cut saw machine and fast cut off of large boards. Suitable for processing single boards with different widths, large boards or beams, for packagers and carpenters (machines such as Weinig OptiCut, Push CrossCutting by Bottene, ...)

HW POSITIVE SAWBLADES FOR ALUMINIUM

ART. LA

Xtra[®] cut

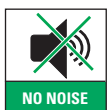
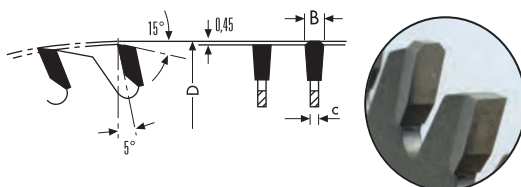

TEETH FEATURES

- FZ/TR (TCG) triple chip teeth
- 5° positive hook angle
- HW grade: KCR10

MATERIALS

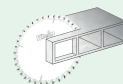

Aluminium profiles

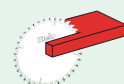

PVC

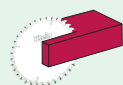

Plastic

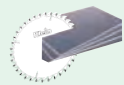

Plexiglass

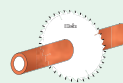

Copper

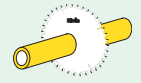

Brass

MACHINES



Power mitre saws



Table saw



Panel saw



Aluminium sawing machines

USEFUL INFORMATION

RPM suggested referred to the blade diameter

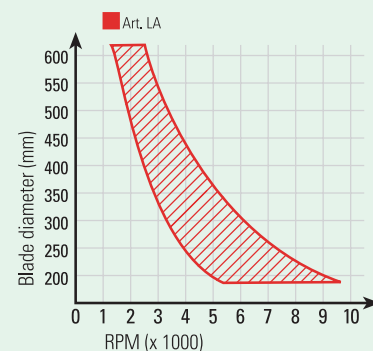

Item	D	d	B/c	Z	Pin holes
LA200.06430	200	30	3,2/2,5	64	2/11/63
LA200.06432	200	32	3,2/2,5	64	2/11/63
LA250.06030	250	30	3,4/2,6	60	2/11/63
LA250.06032	250	32	3,4/2,6	60	2/11/63
LA250.08030	250	30	3,4/2,6	80	2/11/63
LA250.08032	250	32	3,4/2,6	80	2/11/63
LA300.07230	300	30	3,4/2,6	72	2/11/63
LA300.07232	300	32	3,4/2,6	72	2/11/63
LA300.08430	300	30	3,4/2,6	84	2/11/63
LA300.08432	300	32	3,4/2,6	84	2/11/63
LA300.09630	300	30	3,4/2,6	96	2/11/63
LA300.09632	300	32	3,4/2,6	96	2/11/63
LA350.08430	350	30	3,4/2,6	84	2/11/63
LA350.08432	350	32	3,4/2,6	84	2/11/63
LA350.09630	350	30	3,4/2,6	96	2/11/63
LA350.09632	350	32	3,4/2,6	96	2/11/63
LA350.10830	350	30	3,4/2,6	108	2/11/63
LA350.10832	350	32	3,4/2,6	108	2/11/63
LA400.09630	400	30	4,0/3,2	96	2/11/63
LA400.09632	400	32	4,0/3,2	96	2/11/63
LA400.09732	400	32	3,6/3,0	96	2/11/63
LA400.12030	400	30	4,0/3,2	120	2/11/63
LA400.12032	400	32	4,0/3,2	120	2/11/63
LA420.09630	420	30	4,0/3,2	96	2/11/63
LA420.09632	420	32	4,0/3,2	96	2/11/63
LA450.07330	450	30	3,8/3,2	72	2/11/63
LA450.07332	450	32	3,8/3,2	72	2/11/63
LA450.09630	450	30	4,0/3,2	96	2/11/63
LA450.09632	450	32	4,0/3,2	96	2/11/63
LA450.09732	450	32	3,8/3,2	96	2/11/63
LA450.10830	450	30	4,0/3,2	108	2/11/63
LA450.10832	450	32	4,0/3,2	108	2/11/63
LA500.09730	500	30	4,0/3,2	96	2/11/63
LA500.09732	500	32	4,0/3,2	96	2/11/63
LA500.12030	500	30	4,6/3,6	120	2/11/63
LA500.12032	500	32	4,6/3,6	120	2/11/63
LA500.12130	500	30	4,0/3,2	120	2/11/63
LA500.12132	500	32	4,0/3,2	120	2/11/63
LA550.12130	550	30	4,2/3,6	120	2/11/63
LA550.12132	550	32	4,2/3,6	120	2/11/63
LA550.14030	550	30	4,6/3,6	140	2/11/63
LA550.14130	550	30	4,2/3,6	140	2/11/63
LA550.14132	550	32	4,2/3,6	140	2/11/63
LA600.14030	600	30	4,6/3,6	140	2/11/63
LA600.14032	600	32	4,6/3,6	140	2/11/63
LA600.14040	600	40	4,6/3,6	140	2/11/63
LA620.14040	620	40	4,4/3,8	140	2/11/63
LA650.14040	650	40	5,0/4,0	140	2/11/63

HW NEGATIVE SAWBLADES FOR ALUMINIUM

ART. LB

Xtra
cut

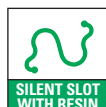
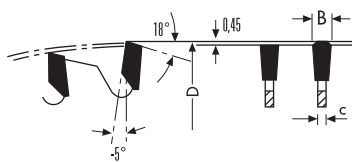

Item	D	d	B/c	Z	Pin holes
LB200.06430	200	30	3,2/2,5	64	2/11/63
LB200.06432	200	32	3,2/2,5	64	2/11/63
LB250.06030	250	30	3,4/2,6	60	2/11/63
LB250.08030	250	30	3,4/2,6	80	2/11/63
LB250.08032	250	32	3,4/2,6	80	2/11/63
LB300.07230	300	30	3,4/2,6	72	2/11/63
LB300.08430	300	30	3,4/2,6	84	2/11/63
LB300.08432	300	32	3,4/2,6	84	2/11/63
LB300.09630	300	30	3,4/2,6	96	2/11/63
LB300.09632	300	32	3,4/2,6	96	2/11/63
LB350.08430	350	30	3,4/2,6	84	2/11/63
LB350.08432	350	32	3,4/2,6	84	2/11/63
LB350.09630	350	30	3,4/2,6	96	2/11/63
LB350.09632	350	32	3,4/2,6	96	2/11/63
LB350.10830	350	30	3,4/2,6	108	2/11/63
LB350.10832	350	32	3,4/2,6	108	2/11/63
LB400.09630	400	30	4,0/3,2	96	2/11/63
LB400.09632	400	32	4,0/3,2	96	2/11/63
LB400.12030	400	30	4,0/3,2	120	2/11/63
LB400.12032	400	32	4,0/3,2	120	2/11/63
LB450.09630	450	30	4,0/3,2	96	2/11/63
LB450.09632	450	32	4,0/3,2	96	2/11/63
LB450.10830	450	30	4,0/3,2	108	2/11/63
LB450.10832	450	32	4,0/3,2	108	2/11/63
LB500.12030	500	30	4,6/3,6	120	2/11/63
LB500.12032	500	32	4,6/3,6	120	2/11/63
LB500.12130	500	30	4,0/3,2	120	2/11/63
LB500.12132	500	32	4,0/3,2	120	2/11/63
LB550.14030	550	30	4,6/3,6	140	2/11/63
LB600.14030	600	30	4,6/3,6	140	2/11/63
LB650.14030	650	30	5,0/4,0	140	2/11/63

TEETH FEATURES

- FZ/TR (TCG) triple chip teeth (TCG)
- -5° negative hook angle
- HW grade: KCR10

MATERIALS

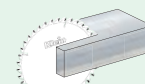

Solid aluminium



PVC

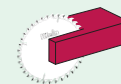

Plastic

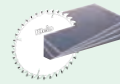

Plexiglass

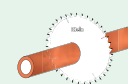

Copper

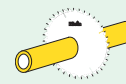

Brass

MACHINES



Power mitre saws



Table saw



Panel saw



Aluminium sawing machines

USEFUL INFORMATION

RPM suggested referred to the blade diameter

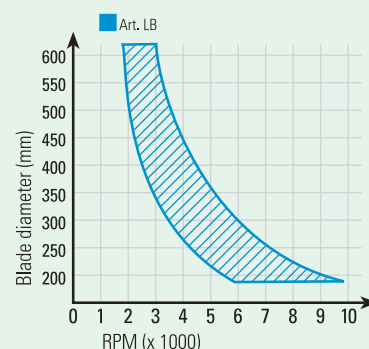

HW SAWBLADES FOR PVC

ART. LE



Xtra®
cut

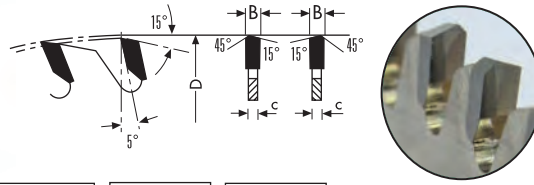

Item	D	d	B/c	Z	Pin holes
LE200.06430	200	30	3,0/2,5	64	
LE250.08030	250	30	3,0/2,5	80	PH01
LE300.09630	300	30	3,0/2,5	96	PH01
LE350.10830	350	30	3,2/2,5	108	PH01
LE400.12030	400	30	3,6/3,0	120	2/11/63
LE450.12030	450	30	3,8/3,2	120	2/11/63
LE500.12030	500	30	4,0/3,2	120	2/11/63
LE550.14030	550	30	4,2/3,5	140	2/11/63
LE600.14030	600	30	4,2/3,5	140	2/11/63

TEETH FEATURES

- WZ/FA alternate-trap, teeth
- HW grade: KCR05+ (K01-C4)

MATERIALS

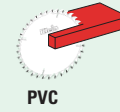
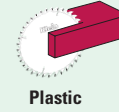

MACHINES



Power mitre saws



Table saw



Panel saw

USEFUL INFORMATION

- Especially made for cutting PVC and thin plastic material thanks to the thinner kerf
- Pin holes: PH01= 2/10/60

HW SAWBLADES FOR PVC AND PLEXIGLASS

ART. MGS

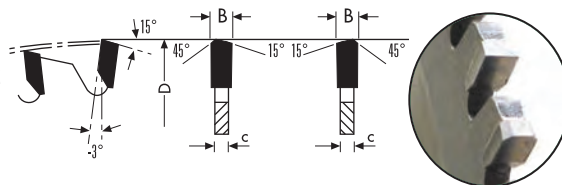

Item	D	d	B/c	Z	Pin holes
MGS250.08030	250	30	2,6/2,0	80	PH02
MGS300.08430	300	30	2,6/2,0	84	PH02
MGS300.09630	300	30	2,6/2,0	96	PH02

TEETH FEATURES

- WZ/FA alternate-trap, teeth
- 3° **negative** hook angle
- HW grade: KCR05+ (K01-C4)

MATERIALS

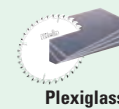
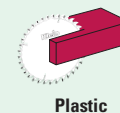
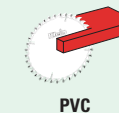

MACHINES



Power mitre saw



Table saw



Panel saw

USEFUL INFORMATION

- Pin holes: PH02= 2/7/42 + 2/9,5/46,5 + 2/10/60

HW SAWBLADES FOR "SOLID SURFACE" AND CHIPBOARD PANELS

ART. MES

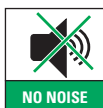
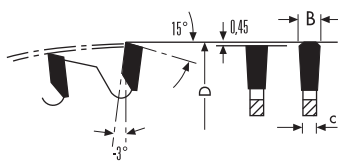

Item	D	d	B/c	Z	Pin holes
MES250.06030	250	30	3,2/2,5	60	PH02
MES250.08030	250	30	3,2/2,5	80	PH02
MES300.08430	300	30	3,2/2,5	84	PH02
MES300.09630	300	30	3,2/2,5	96	PH02
MES350.11230	350	30	3,2/2,5	112	PH02

RPM suggested referred to the blade diameter

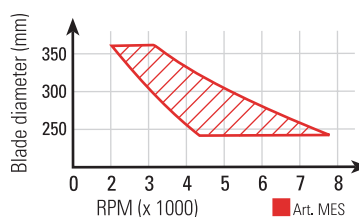

TEETH FEATURES

- FZ/TR (TCG) triple chip teeth
- 3° negative hook angle
- HW grade: KCR05+ (K01-C4)

MATERIALS

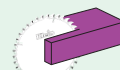

Solid surface



Plastic

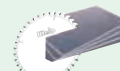

Plexiglass

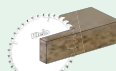

Chipboard



MDF

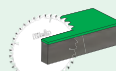

HPL

MACHINES



Power mitre saw



Table saw



Panel saw

USEFUL INFORMATION

- High finishing grade, no scratch, no risk of material melting
- Pin holes: PH02= 2/7/42 + 2/9,5/46,5 + 2/10/60

REDUCTION RINGS FOR SAWBLADES

ART. ZA

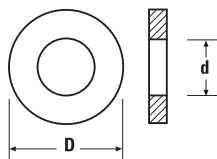

Item	D	d
ZA000.02012	20	12,7
ZA000.02013 selling out	20	13
ZA000.02015 selling out	20	15
ZA000.02016	20	16
ZA000.03015 selling out	30	15
ZA000.03016	30	16
ZA000.03020	30	20
ZA000.03025	30	25
ZA000.03026	30	25,4
ZA000.03028 selling out	30	28,6
ZA000.03220	32	20
ZA000.03230	32	30
ZA000.03516	35	16
ZA000.03520	35	20
ZA000.03526	35	26
ZA000.03530	35	30
ZA000.03532	35	32
ZA000.04030	40	30
ZA000.04032	40	32
ZA000.04035	40	35

HW "DRY" OR "QUATTRO" SAWBLADES

ART. LZ

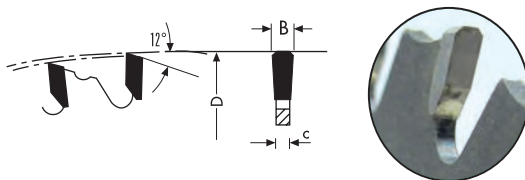
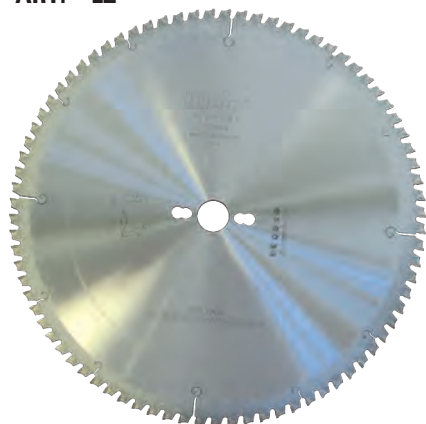

Item	D	d	B/c	Z	Pin holes
LZ150.03020	150	20	2,2/1,6	30	
LZ160.03020	160	20	2,2/1,6	30	
LZ180.03430	180	30	2,2/1,6	30	
LZ190.03830	190	30	2,2/1,6	38	
LZ200.04030	200	30	2,2/1,6	40	
LZ210.04030	210	30	2,2/1,6	40	
LZ230.04430	230	30	2,2/1,6	40	2/7/42
LZ250.04820	250	20	2,4/1,8	48	2/7/42
LZ250.04830	250	30	2,4/1,8	48	2/7/42
LZ300.06026	300	25,4	2,4/1,8	60	2/7/42+2/10/60
LZ300.06030	300	30	2,4/1,8	60	2/7/42+2/10/60
LZ305.08026	305	25,4	2,4/1,8	80	2/7/42+2/10/60
LZ350.08030	350	30	2,6/2,0	70	2/7/42+2/10/60
LZ355.08026	355	25,4	2,6/2,0	80	2/7/42+2/10/60
LZ400.08430	400	30	3,0/2,0	84	2/10/60

TEETH FEATURES

- TR special form of teeth
- HW grade: SMX (P20 - P25 - C6)

MATERIALS

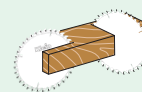

Hardwood

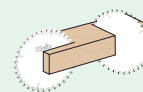

Softwood

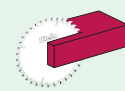

Plastic

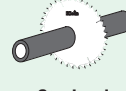

Steel and ferrous material

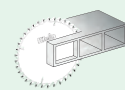

Aluminium profiles

MACHINES



Portable saw



Power mitre saw



Table saw

USEFUL INFORMATION

- "QUATTRO" like the four kind of material that can be cut with these sawblades: for cutting **wood, ferrous and non-ferrous material, plastic and compound materials, composite panels...**
- RPM suggested referred to the blade diameter

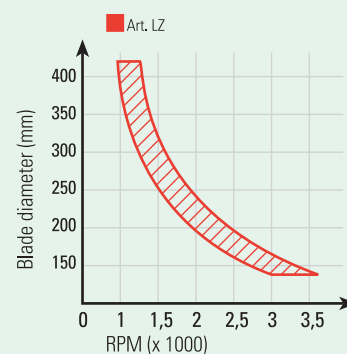

HW DM05 SAWBLADES FOR FERROUS MATERIALS

ART. PA - PB

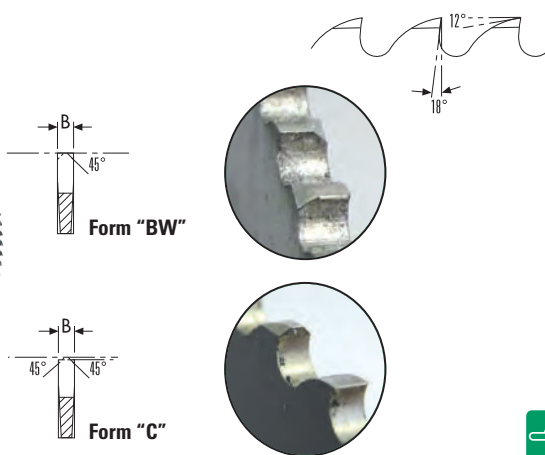

em	D	d	B	Form	Z	Pin holes
PA225.12032	225	32	2,0	C	120	2/8/45+2/11/63+2/9/50
PA225.12040	225	40	2,0	C	120	2/8/55+4/12/64
PB225.18032	225	32	2,0	BW	180	2/8/45+2/11/63+2/9/50
PB225.18040	225	40	2,0	BW	180	2/8/55+4/12/64
PA250.12832	250	32	2,0	C	128	2/8/45+2/11/63+2/9/50
PA250.12840	250	40	2,0	C	128	2/8/55+4/12/64
PB250.20032	250	32	2,0	BW	200	2/8/45+2/11/63+2/9/50
PB250.20040	250	40	2,0	BW	200	2/8/55+4/12/64
PA275.14032	275	32	2,5	C	140	2/8/45+2/11/63+2/9/50
PA275.14040	275	40	2,5	C	140	2/8/55+4/12/64
PB275.22032	275	32	2,5	BW	220	2/8/45+2/11/63+2/9/50
PB275.22040	275	40	2,5	BW	220	2/8/55+4/12/64
PA300.16032	300	32	2,5	C	160	2/8/45+2/11/63+2/9/50
PA300.16040	300	40	2,5	C	160	2/8/55+4/12/64
PB300.22032	300	32	2,5	BW	220	2/8/45+2/11/63+2/9/50
PB300.22040	300	40	2,5	BW	220	2/8/55+4/12/64
PA315.16032	315	32	2,5	C	160	2/8/45+2/11/63+2/9/50
PA315.16040	315	40	2,5	C	160	2/8/55+4/12/64
PB315.22032	315	32	2,5	BW	220	2/8/45+2/11/63+2/9/50
PB315.22040	315	40	2,5	BW	220	2/8/55+4/12/64
PA325.16040	325	40	2,5	C	160	2/8/55+4/12/64
PA350.18032	350	32	2,5	C	180	2/8/45+2/11/63+2/9/50
PB350.28032	350	32	2,5	BW	280	2/8/45+2/11/63+2/9/50
PA370.19040	370	40	3,0	C	190	2/8/55+4/12/64
PA400.16040	400	40	3,0	C	160	2/8/55+4/12/64

TEETH FEATURES

- Item **PA** = teeth form "C" suitable for cutting steel tube with thickness greater than 3 mm.
- Item **PB** = teeth form "BW" suitable for thinner steel tube

MATERIALS

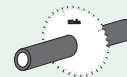

Steel and ferrous material

MACHINES



Power mitre saw

USEFUL INFORMATION

- Vaporized execution for steel, pipe, ferrous materials



CUTTERHEADS



HW "LAMELLO" - GROOVE CUTTER
Page 13.03



HW "LAMELLO" - GROOVE CUTTER
Page 13.03



HW ADJUSTABLE GROOVE CUTTER
Page 13.03



STEEL CUTTERHEADS B=40
WITH CHIP LIMITERS
Page 13.04



STEEL CUTTERHEADS B=40
WITHOUT CHIP LIMITERS
Page 13.04



LIGHT ALLOY CUTTERHEADS
B=40÷50 WITH CHIP LIMITERS
Page 13.05



LIGHT ALLOY CUTTERHEADS B=40÷50
WITHOUT CHIP LIMITERS
Page 13.05



BLANK KNIVES AND LIMITERS
IN "SP" STEEL
Page 13.05



7 PROFILE CUTTERHEAD SETS WITH KNIVES
AND CHIP LIMITERS (PROFILES 0÷6)
Page 13.06



7 PROFILE CUTTERHEAD SETS
WITH KNIVES (PROFILES 0÷6)
Page 13.06



13 PROFILE CUTTERHEAD SETS WITH
KNIVES AND CHIP LIMITERS
(PROFILES 0÷12)
Page 13.07



13 PROFILE CUTTERHEAD SETS
WITH KNIVES (PROFILES 0÷12)
Page 13.07



13 PROFILE CUTTERHEAD SETS WITH KNIVES
AND CHIP LIMITERS (PROFILES 13÷24)
Page 13.08



13 PROFILE CUTTERHEAD SETS
WITH KNIVES (PROFILES 13÷24)
Page 13.08



13 PROFILE CUTTERHEAD SETS WITH
KNIVES AND CHIP LIMITERS
(PROFILES 25÷36)
Page 13.09



13 PROFILE CUTTERHEAD SETS
WITH KNIVES (PROFILES 25÷36)
Page 13.09



STANDARD PROFILE KNIVES IN "SP"
STEEL - height 40x4 mm (RELATING LIMITERS)
Pag. 13.10÷13.15

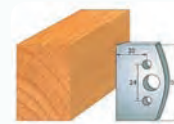

STANDARD PROFILE KNIVES IN "SP" STEEL
- height 50x4 mm (RELATING LIMITERS)
Pag. 13.16÷13.19



HW ADJUSTABLE CUTTERHEAD WITH
REVERSIBLE KNIVES FOR GROOVES
Page 13.20



HW CUTTERHEADS WITH REVERSIBLE
KNIVES FOR "LAMELLO"
Page 13.21





HW ADJUSTABLE CUTTERHEAD WITH REVERSIBLE KNIVES FOR GROOVES
Page 13.21



HW ADJUSTABLE GROOVING CUTTERHEAD FOR TENONS
Page 13.22



HW CUTTERHEAD WITH REVERSIBLE STRAIGHT A AND SPURS
Page 13.22



HW CUTTERHEAD WITH REVERSIBLE STRAIGHT KNIVES AND SPURS
Page 13.23



HW INSERT RABBETING CUTTER HEADS Z=2+2
Page 13.23

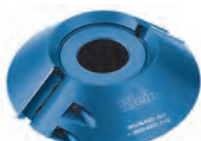

HW CUTTERHEAD FOR 45° BEVELS
Page 13.24



HW ADJUSTABLE BEVEL CUTTERHEAD
Page 13.25



HW ADJUSTABLE BEVEL CUTTERHEAD
Page 13.25



HW TOOLING SET FOR ROUNDING AND CHAMFERING
Page 13.26



HW MULTIRADIUS SET
Page 13.27



HW TOOLING SET FOR CONCAVE AND CONVEX QUARTER ROUNDS
Page 13.28



MULTIPROFILE SET
Pag. 13.29



HW MITRE JOINT CUTTERHEAD 45°
Page 13.30



HW PROFILE CUTTER
Page 13.30



HW PANEL RAISING SET WITH SIX PROFILES
Page 13.31



HW PANEL RAISING SET
Page 13.32



HW PANEL RAISING SET
Page 13.33



HW PANEL RAISING SET
Page 13.34



COUNTERPROFILE-RAISING PANEL SET
Page 13.34



HW TOOLING SET FOR PROFILES AND COUNTERPROFILES
Page 13.35



TONGUE AND GROOVE TOOLING SET
Page 13.36



PLANERHEAD
Page 13.37



GUIDE BALL BEARINGS FOR SAWING OUT
Page 13.37



GUIDE RINGS FOR BALL BEARING
Page 13.37



REDUCTION RINGS FOR CUTTERHEADS
Page 13.38



REDUCING BUSHES
Page 13.38



BALL BEARING WITH BUTTING RING SET
Page 13.38

HW "LAMELLO"® - GROOVE CUTTER

ART. AH

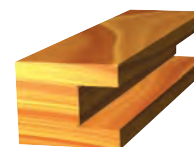
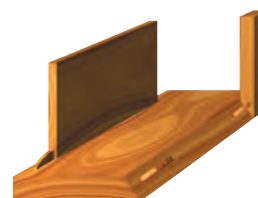
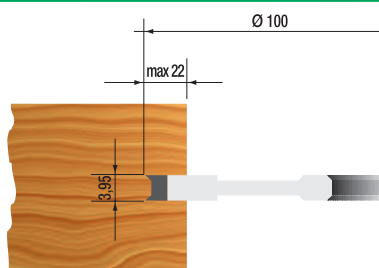
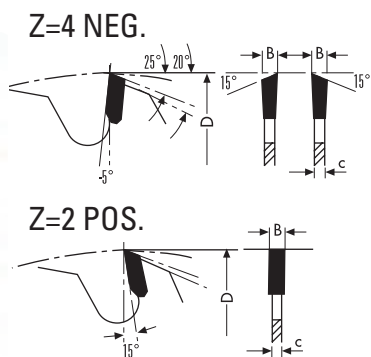

- T.C.T. brazed cutter with spurs for making grooves on any kind of wood
- For hand milling machines
- Suitable for "Lamello" and Clamex S biscuit joiners
- For Zeta, Top 20, Top 21, Classic systems
- Manual feed
- Can also be used on CNC machines together with adapter (item T128.141.R)

Item	D	d	B	Z	V	Pin holes
AH100.20622	100	22	3,95	2	4	4/4/36

HW "LAMELLO"® - GROOVE CUTTER

ART. RA

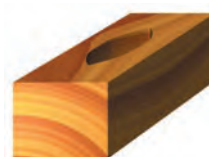
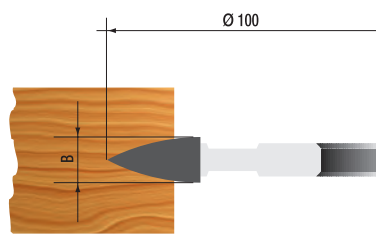

- T.C.T. brazed cutters for manual feed for Lamello® hand milling machines
- Manual feed (MAN)

Item	D	d	B	Z	Pin holes
RA100.08022	100	22	8	4	4/4/36
RA100.15022	100	22	15	4	4/4/36

HW ADJUSTABLE GROOVE CUTTER

ART. RA

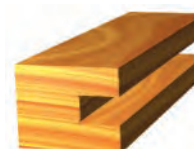
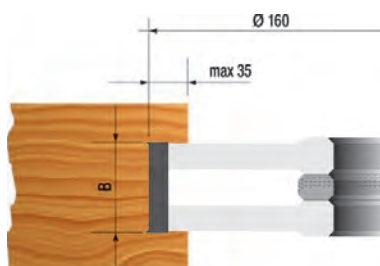

- T.C.T. brazed cutter with spurs for precision grooves
- Manual feed (MAN)

Item	D	d	B	Z	V
RA160.07530	160	30	4÷7,5	4	4
RA160.14030	160	30	7,5÷14	4	4

STEEL CUTTERHEADS B=40 WITH CHIP LIMITERS

ART. SA

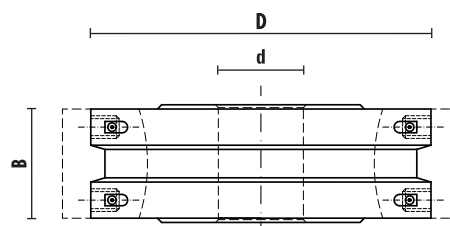

- Tool body in steel
- Equipped with SP knives and chip limiters profile "0"
- For spindle moulders with manual feed (MAN)
- To be used with knives **B=40x4 mm** (Art. SA0 page 13.10÷13.15) and chip limiters (Art. SA1 page 13.10÷13.15)
- For solid wood

Item	D	d	B	Z	n min	n max
SA078.40030	78	30	40	2	7000	9000
SA093.40030	93	30	40	2	5800	8600
SA100.40030	100	30	40	2	5500	8400
SA120.40030	120	30	40	2	4800	7700
SA120.40035	120	35	40	2	4800	7700
SA120.40050	120	50	40	2	4800	7700



Z056.790.R



Z051.704.R



Z052.003.R

STEEL CUTTERHEADS B=40 WITHOUT CHIP LIMITERS

ART. SA

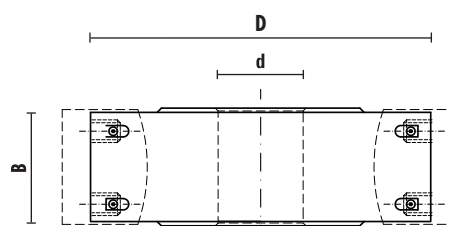

- Tool body in steel
- Equipped with SP knives profile "0"
- For spindle moulders with mechanical feed (MEC)
- To be used with knives **B=40x4 mm** (Art. SA0 page 13.10÷13.15)

Item	D	d	B	Z	n min	n max
SA078.40130	78	30	40	2	7000	9000
SA093.40130	93	30	40	2	5800	8600
SA100.40130	100	30	40	2	5500	8400
SA120.40135	120	35	40	2	4800	7700
SA120.40150	120	50	40	2	4800	7700



Z056.791.R



Z051.705.R



Z052.003.R

LIGHT ALLOY CUTTERHEADS B=40÷50 WITH CHIP LIMITERS

ART. SAL

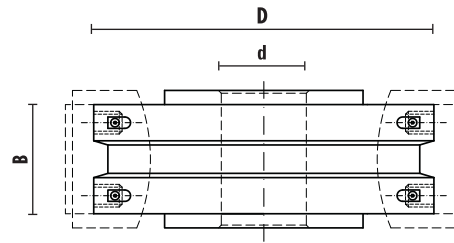

- Tool body in light alloy
- Equipped with SP knives and chip limiters profile "0"
- For spindle moulders with manual feed (MAN)
- To be used with knives **B=40x4 mm** (Art. SA0 page 13.10÷13.15) and chip limiters (Art. SA1 page 13.10÷13.15) or **B=50x4 mm** (Art. SA2 page 13.16÷13.20) and chip limiters (Art. SA3 page 13.16÷13.20)

Item	D	d	B	Z	n min	n max
SAL100.45030	100	30	40÷50	2	5500	8400
SAL120.45035	120	35	40÷50	2	4800	7400
SAL120.45050	120	50	40÷50	2	4800	7400



Z056.790.R



Z051.704.R



Z052.003.R

LIGHT ALLOY CUTTERHEADS B=40÷50 WITHOUT CHIP LIMITERS

ART. SAL

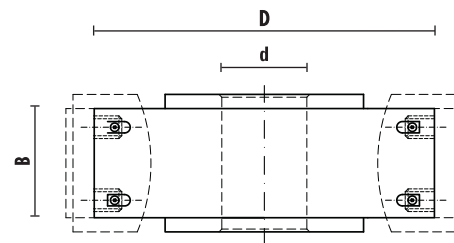

- Tool body in light alloy
- Equipped with SP knives and chip limiters profile "0"
- For spindle moulders with mechanical feed (MEC)
- To be used with knives **B=40x4 mm** (Art. SA0 page 13.10÷13.15) or **B=50x4 mm** (Art. SA2 page 13.16÷13.20)

Item	D	d	B	Z	n min	n max
SAL100.45130	100	30	40÷50	2	5500	8400
SAL120.45135	120	35	40÷50	2	4800	7400
SAL120.45150	120	50	40÷50	2	4800	7400



Z056.791.R



Z051.705.R



Z052.003.R

BLANK KNIVES AND LIMITERS IN "SP" STEEL

ART. SA

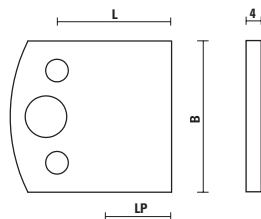

- They have to be sharpened within "LP" dimension
- Sold in pairs
- Full range at page 13.10

Item	B	L	C	LP	Type
SA000X	40	33,5	4	18	Knife
SA100X	38	32,5	4	18	Limiter
SA200X	50	34	4	20	Knife
SA300X	48	33	4	20	Limiter

7 PROFILE CUTTERHEAD SETS WITH KNIVES AND CHIP LIMITERS (PROFILES 0÷6)

ART. SX001 - SXL001

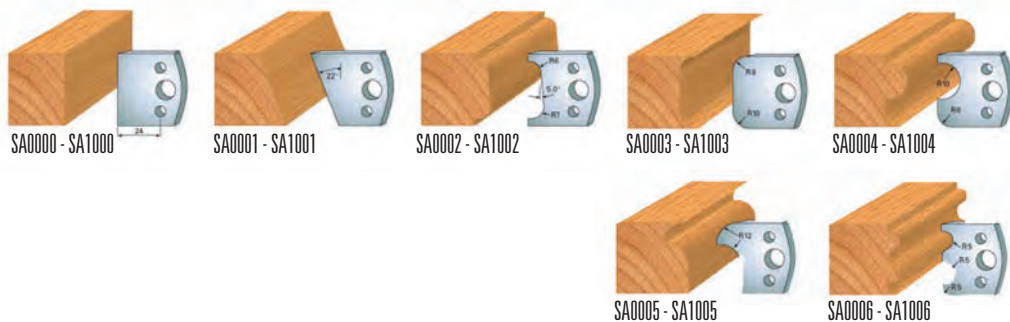

- Set in plastic box complete with cutterhead, **SP steel knives and chip limiters profiles 0÷6**
- Cutterhead Z=2 tool body in steel (**Art. SX**)
- Cutterhead Z=2 tool body in light alloy (**Art. SXL**)
- For spindle moulders with manual feed (MAN)

Item	Description
SX001.078.40030	Complete with cutterhead in steel body D=78 - Bore 30 - B=40 (Art. SA078.40030) + Profiles and chip limiters 0÷6
SX001.093.40030	Complete with cutterhead in steel body D=93 - Bore 30 - B=40 (Art. SA093.40030) + Profiles and chip limiters 0÷6
SX001.100.40030	Complete with cutterhead in steel body D=100 - Bore 30 - B=40 (Art. SA100.40030) + Profiles and chip limiters 0÷6
SX001.120.40035	Complete with cutterhead in steel body D=120 - Bore 35 - B=40 (Art. SA120.40035) + Profiles and chip limiters 0÷6
SX001.120.40050	Complete with cutterhead in steel body D=120 - Bore 50 - B=40 (Art. SA120.40050) + Profiles and chip limiters 0÷6
SXL001.100.45030	Complete with cutterhead in light alloy body D=100 - Bore 30 - B=40÷50 (Art. SAL100.45030) + Profiles and chip limiters 0÷6
SXL001.120.45035	Complete with cutterhead in light alloy body D=120 - Bore 35 - B=40÷50 (Art. SAL120.45035) + Profiles and chip limiters 0÷6
SXL001.120.45050	Complete with cutterhead in light alloy body D=120 - Bore 50 - B=40÷50 (Art. SAL120.45050) + Profiles and chip limiters 0÷6

7 PROFILE CUTTERHEAD SETS WITH KNIVES (PROFILES 0÷6)

ART. SX001 - SXL001

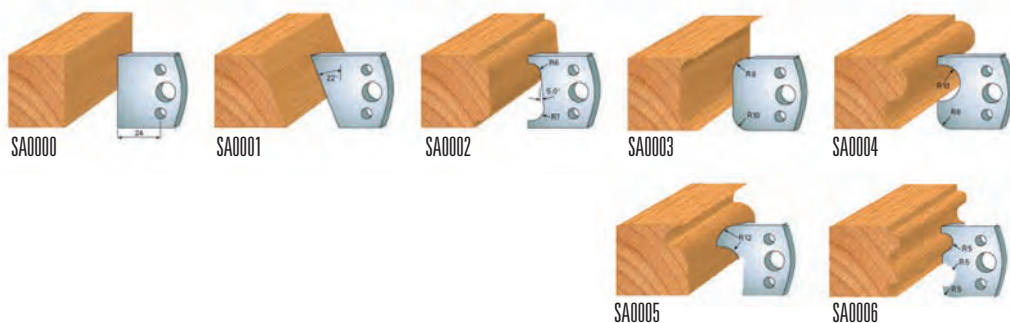

- Set in plastic box complete with cutterheads and SP steel knives 0÷6 (**without chip limiters**)
- Cutterhead Z=2 tool body in steel (**Art. SX**)
- Cutterhead Z=2 tool body in light alloy (**Art. SXL**)
- For spindle moulders with mechanical feed (MEC)

Item	Description
SX001.078.40130	Complete with cutterhead in steel body D=78 - Bore 30 - B=40 (Art. SA078.40130) + Profiles 0÷6
SX001.093.40130	Complete with cutterhead in steel body D=93 - Bore 30 - B=40 (Art. SA093.40130) + Profiles 0÷6
SX001.100.40130	Complete with cutterhead in steel body D=100 - Bore 30 - B=40 (Art. SA100.40130) + Profiles 0÷6
SX001.120.40135	Complete with cutterhead in steel body D=120 - Bore 35 - B=40 (Art. SA120.40135) + Profiles 0÷6
SX001.120.40150	Complete with cutterhead in steel body D=120 - Bore 50 - B=40 (Art. SA120.40150) + Profiles 0÷6
SXL001.100.45130	Complete with cutterhead in light alloy body D=100 - Bore 30 - B=40÷50 (Art. SAL100.45130) + Profiles 0÷6
SXL001.120.45135	Complete with cutterhead in light alloy body D=120 - Bore 35 - B=40÷50 (Art. SAL120.45135) + Profiles 0÷6
SXL001.120.45150	Complete with cutterhead in light alloy body D=120 - Bore 50 - B=40÷50 (Art. SAL120.45150) + Profiles 0÷6

13 PROFILE CUTTERHEAD SETS WITH KNIVES AND CHIP LIMITERS (PROFILES 0÷12)

ART. SX002 - SXL002

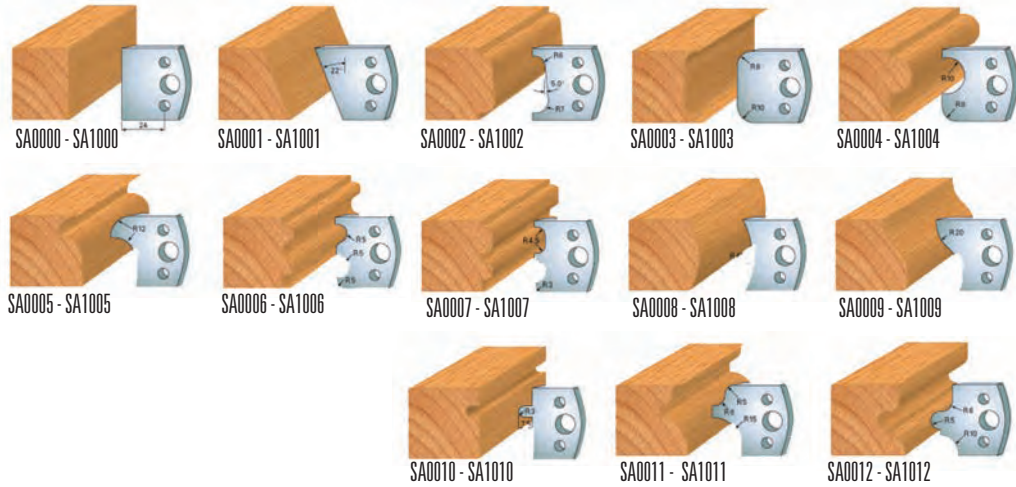

- Set in plastic box complete with cutterheads, **SP steel knives and chip limiters profile 0÷12**
- Cutterhead Z=2 tool body in steel (**Art. SX**)
- Cutterhead Z=2 tool body in light alloy (**Art. SXL**)
- For spindle moulders with manual feed (MAN)

Item	Description
SX002.078.40030	Complete with cutterhead in steel body D=78 - Bore 30 - B=40 (Art. SA078.40030) + Profiles and chip limiters 0÷12
SX002.093.40030	Complete with cutterhead in steel body D=93 - Bore 30 - B=40 (Art. SA093.40030) + Profiles and chip limiters 0÷12
SX002.100.40030	Complete with cutterhead in steel body D=100 - Bore 30 - B=40 (Art. SA100.40030) + Profiles and chip limiters 0÷12
SX002.120.40035	Complete with cutterhead in steel body D=120 - Bore 35 - B=40 (Art. SA120.40035) + Profiles and chip limiters 0÷12
SX002.120.40050	Complete with cutterhead in steel body D=120 - Bore 50 - B=40 (Art. SA120.40050) + Profiles and chip limiters 0÷12
SXL002.100.45030	Complete with cutterhead in light alloy body D=100 - Bore 30 - B=40÷50 (Art. SAL100.45030) + Profiles and chip limiters 0÷12
SXL002.120.45035	Complete with cutterhead in light alloy body D=120 - Bore 35 - B=40÷50 (Art. SAL120.45035) + Profiles and chip limiters 0÷12
SXL002.120.45050	Complete with cutterhead in light alloy body D=120 - Bore 50 - B=40÷50 (Art. SAL120.45050) + Profiles and chip limiters 0÷12

13 PROFILE CUTTERHEAD SETS WITH KNIVES (PROFILES 0÷12)

ART. SX002 - SXL002

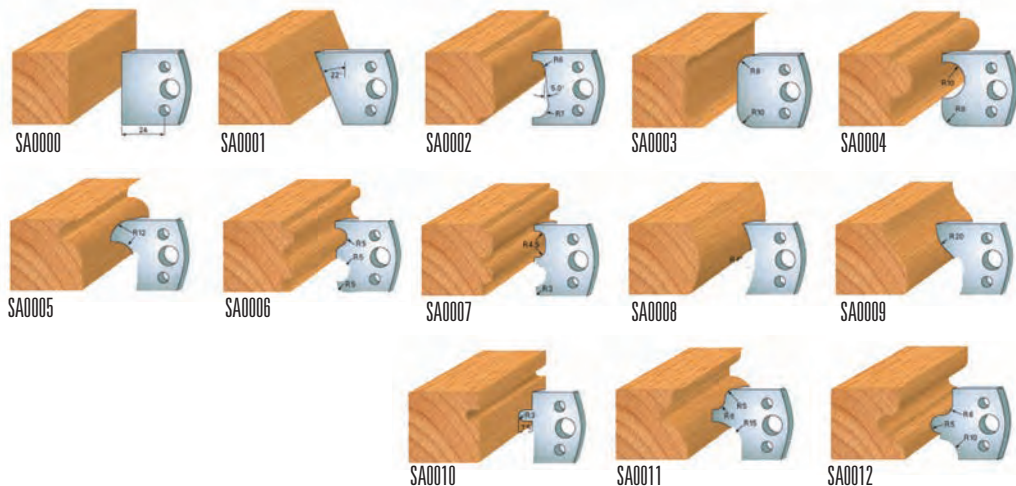

- Set in plastic box complete with cutterheads and SP steel knives 0÷12 (**without chip limiters**)
- Cutterhead Z=2 tool body in steel (**Art. SX**)
- Cutterhead Z=2 tool body in light alloy (**Art. SXL**)
- For spindle moulders with mechanical feed (MEC)

Item	Description
SX002.078.40130	Complete with cutterhead in steel body D=78 - Bore 30 - B=40 (Art. SA078.40130) + Profiles 0÷12
SX002.093.40130	Complete with cutterhead in steel body D=93 - Bore 30 - B=40 (Art. SA093.40130) + Profiles 0÷12
SX002.100.40130	Complete with cutterhead in steel body D=100 - Bore 30 - B=40 (Art. SA100.40130) + Profiles 0÷12
SX002.120.40135	Complete with cutterhead in steel body D=120 - Bore 35 - B=40 (Art. SA120.40135) + Profiles 0÷12
SX002.120.40150	Complete with cutterhead in steel body D=120 - Bore 50 - B=40 (Art. SA120.40150) + Profiles 0÷12
SXL002.100.45130	Complete with cutterhead in light alloy body D=100 - Bore 30 - B=40÷50 (Art. SAL100.45130) + Profiles 0÷12
SXL002.120.45135	Complete with cutterhead in light alloy body D=120 - Bore 35 - B=40÷50 (Art. SAL120.45135) + Profiles 0÷12
SXL002.120.45150	Complete with cutterhead in light alloy body D=120 - Bore 50 - B=40÷50 (Art. SAL120.45150) + Profiles 0÷12

13 PROFILE CUTTERHEAD SETS WITH KNIVES AND CHIP LIMITERS (PROFILES 13÷24)

ART. SX003 - SXL003

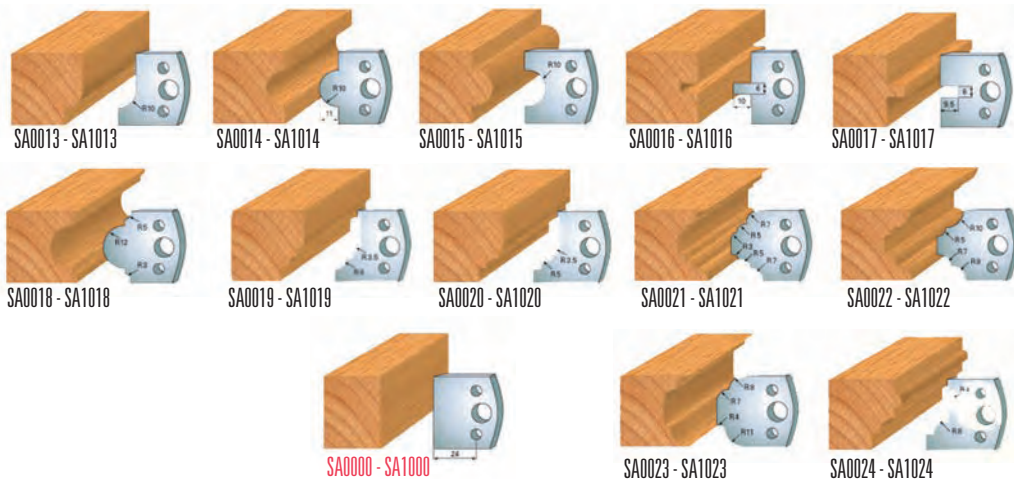

- Set in plastic box complete with cutterheads, **SP steel knives and chip limiters profile 0+13÷24**
- Cutterhead Z=2 tool body in steel (**Art. SX**)
- Cutterhead Z=2 tool body in light alloy (**Art. SXL**)
- For spindle moulders with manual feed (MAN)

Item	Description
SX003.078.40030	Complete with cutterhead in steel body D=78 - Bore 30 - B=40 (Art. SA078.40030) + Profiles and chip limiters 13÷24
SX003.093.40030	Complete with cutterhead in steel body D=93 - Bore 30 - B=40 (Art. SA093.40030) + Profiles and chip limiters 13÷24
SX003.100.40030	Complete with cutterhead in steel body D=100 - Bore 30 - B=40 (Art. SA100.40030) + Profiles and chip limiters 13÷24
SX003.120.40035	Complete with cutterhead in steel body D=120 - Bore 35 - B=40 (Art. SA120.40035) + Profiles and chip limiters 13÷24
SX003.120.40050	Complete with cutterhead in steel body D=120 - Bore 50 - B=40 (Art. SA120.40050) + Profiles and chip limiters 13÷24
SXL003.100.45030	Complete with cutterhead in light alloy body D=100 - Bore 30 - B=40÷50 (Art. SAL100.45030) + Profiles and chip limiters 13÷24
SXL003.120.45035	Complete with cutterhead in light alloy body D=120 - Bore 35 - B=40÷50 (Art. SAL120.45035) + Profiles and chip limiters 13÷24
SXL003.120.45050	Complete with cutterhead in light alloy body D=120 - Bore 50 - B=40÷50 (Art. SAL120.45050) + Profiles and chip limiters 13÷24

13 PROFILE CUTTERHEAD SETS WITH KNIVES (PROFILES 13÷24)

ART. SX003 - SXL003

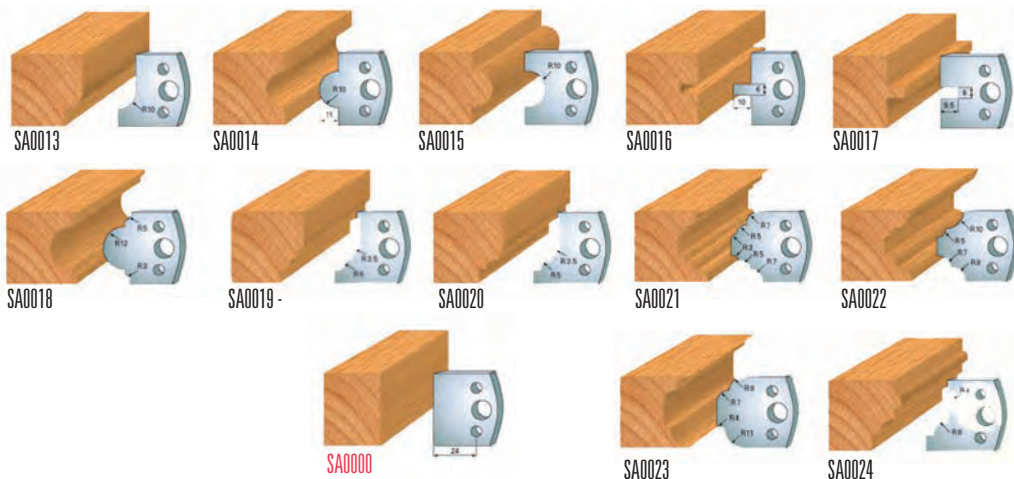

- Set in plastic box complete with cutterheads and SP steel knives 0+13÷24 (**without chip limiters**)
- Cutterhead Z=2 tool body in steel (**Art. SX**)
- Cutterhead Z=2 tool body in light alloy (**Art. SXL**)
- For spindle moulders with mechanical feed (MEC)

Item	Description
SX003.078.40130	Complete with cutterhead in steel body D=78 - Bore 30 - B=40 (Art. SA078.40130) + Profiles 13÷24
SX003.093.40130	Complete with cutterhead in steel body D=93 - Bore 30 - B=40 (Art. SA093.40130) + Profiles 13÷24
SX003.100.40130	Complete with cutterhead in steel body D=100 - Bore 30 - B=40 (Art. SA100.40130) + Profiles 13÷24
SX003.120.40135	Complete with cutterhead in steel body D=120 - Bore 35 - B=40 (Art. SA120.40135) + Profiles 13÷24
SX003.120.40150	Complete with cutterhead in steel body D=120 - Bore 50 - B=40 (Art. SA120.40150) + Profiles 13÷24
SXL003.100.45130	Complete with cutterhead in light alloy body D=100 - Bore 30 - B=40÷50 (Art. SAL100.45130) + Profiles 13÷24
SXL003.120.45135	Complete with cutterhead in light alloy body D=120 - Bore 35 - B=40÷50 (Art. SAL120.45135) + Profiles 13÷24
SXL003.120.45150	Complete with cutterhead in light alloy body D=120 - Bore 50 - B=40÷50 (Art. SAL120.45150) + Profiles 13÷24

13 PROFILE CUTTERHEAD SETS WITH KNIVES AND CHIP LIMITERS (PROFILES 25÷36)

ART. SX004 - SXL004

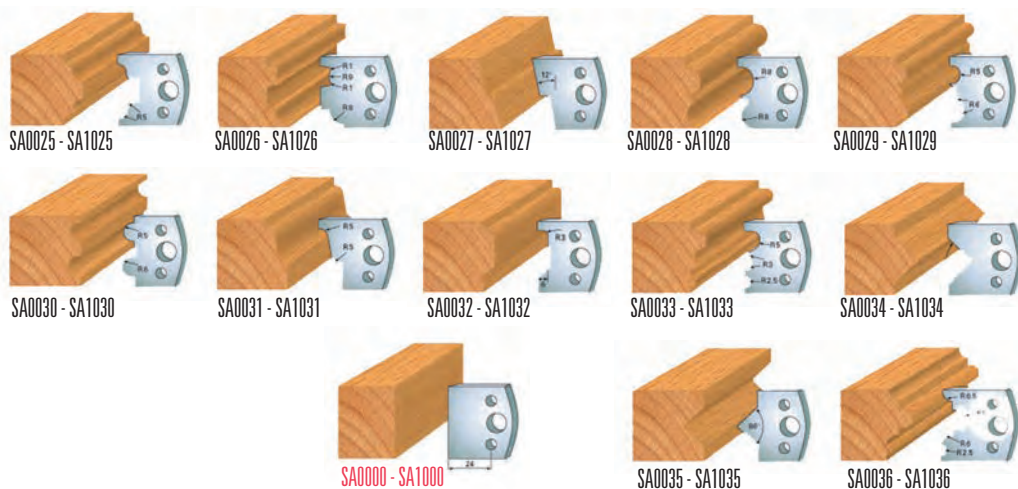

- Set in plastic box complete with cutterheads, **SP steel knives and chip limiters profile 0÷25÷36**
- Cutterhead Z=2 tool body in steel (**Art. SX**)
- Cutterhead Z=2 tool body in light alloy (**Art. SXL**)
- For spindle moulders with manual feed (MAN)

Item	Description
SX004.078.40030	Complete with cutterhead in steel body D=78 - Bore 30 - B=40 (Art. SA078.40030) + Profiles and chip limiters 25÷36
SX004.093.40030	Complete with cutterhead in steel body D=93 - Bore 30 - B=40 (Art. SA093.40030) + Profiles and chip limiters 25÷36
SX004.100.40030	Complete with cutterhead in steel body D=100 - Bore 30 - B=40 (Art. SA100.40030) + Profiles and chip limiters 25÷36
SX004.120.40035	Complete with cutterhead in steel body D=120 - Bore 35 - B=40 (Art. SA120.40035) + Profiles and chip limiters 25÷36
SX004.120.40050	Complete with cutterhead in steel body D=120 - Bore 50 - B=40 (Art. SA120.40050) + Profiles and chip limiters 25÷36
SXL004.100.45030	Complete with cutterhead in light alloy body D=100 - Bore 30 - B=40÷50 (Art. SAL100.45030) + Profiles and chip limiters 25÷36
SXL004.120.45035	Complete with cutterhead in light alloy body D=120 - Bore 35 - B=40÷50 (Art. SAL120.45035) + Profiles and chip limiters 25÷36
SXL004.120.45050	Complete with cutterhead in light alloy body D=120 - Bore 50 - B=40÷50 (Art. SAL120.45050) + Profiles and chip limiters 25÷36

13 PROFILE CUTTERHEAD SETS WITH KNIVES (PROFILES 25÷36)

ART. SX004 - SXL004

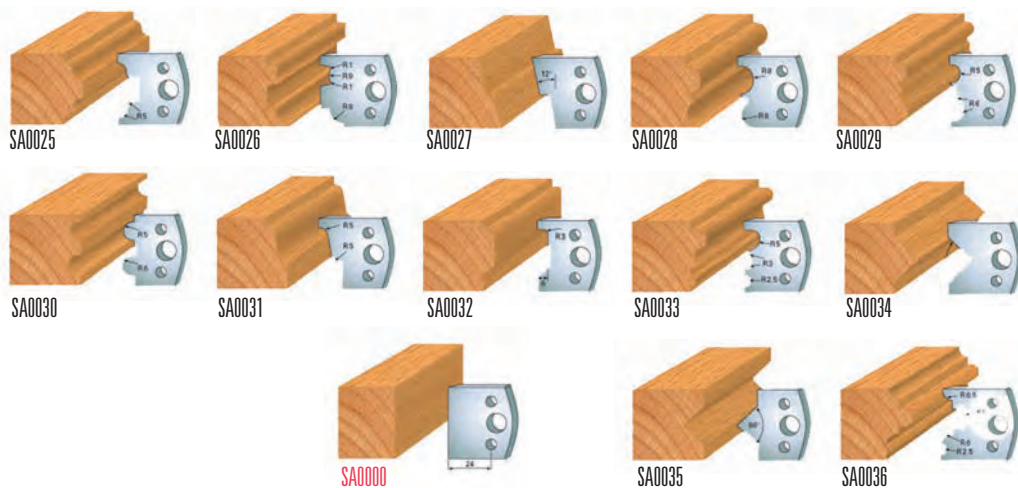

- Set in plastic box complete with cutterheads and SP steel knives 0÷25÷36 (**without chip limiters**)
- Cutterhead Z=2 tool body in steel (**Art. SX**)
- Cutterhead Z=2 tool body in light alloy (**Art. SXL**)
- For spindle moulders with mechanical feed (MEC)

Item	Description
SX004.078.40130	Complete with cutterhead in steel body D=78 - Bore 30 - B=40 (Art. SA078.40130) + Profiles 25÷36
SX004.093.40130	Complete with cutterhead in steel body D=93 - Bore 30 - B=40 (Art. SA093.40130) + Profiles 25÷36
SX004.100.40130	Complete with cutterhead in steel body D=100 - Bore 30 - B=40 (Art. SA100.40130) + Profiles 25÷36
SX004.120.40135	Complete with cutterhead in steel body D=120 - Bore 35 - B=40 (Art. SA120.40135) + Profiles 25÷36
SX004.120.40150	Complete with cutterhead in steel body D=120 - Bore 50 - B=40 (Art. SA120.40150) + Profiles 25÷36
SXL004.100.45130	Complete with cutterhead in light alloy body D=100 - Bore 30 - B=40÷50 (Art. SAL100.45130) + Profiles 25÷36
SXL004.120.45135	Complete with cutterhead in light alloy body D=120 - Bore 35 - B=40÷50 (Art. SAL120.45135) + Profiles 25÷36
SXL004.120.45150	Complete with cutterhead in light alloy body D=120 - Bore 50 - B=40÷50 (Art. SAL120.45150) + Profiles 25÷36

**STANDARD PROFILE KNIVES IN "SP" STEEL - height 40x4 mm
(RELATING LIMITERS)**

**Example:
Knife SA0..
Limiter (SA1..)**

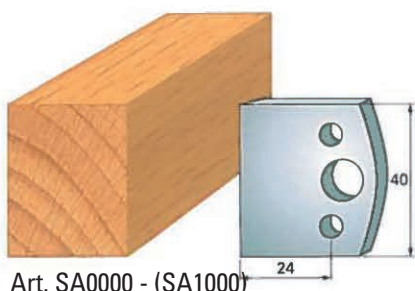

Art. SA0000 - (SA1000)

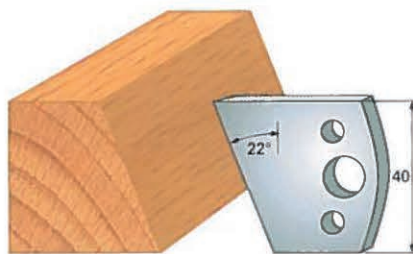

Art. SA0001 - (SA1001)

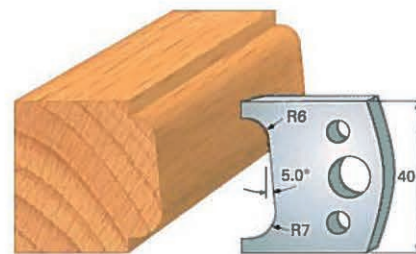

Art. SA0002 - (SA1002)

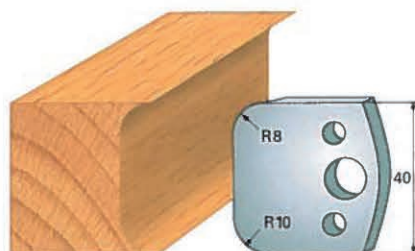

Art. SA0003 - (SA1003)

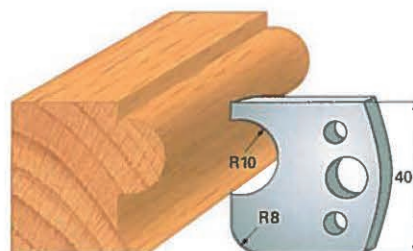

Art. SA0004 - (SA1004)

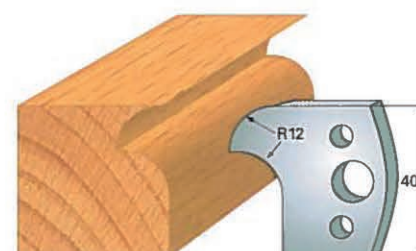

Art. SA0005 - (SA1005)

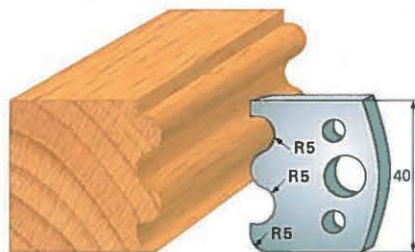

Art. SA0006 - (SA1006)

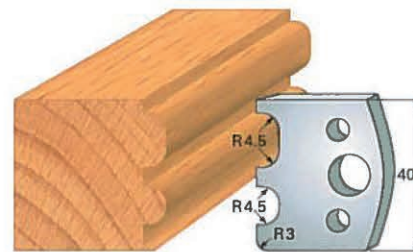

Art. SA0007 - (SA1007)

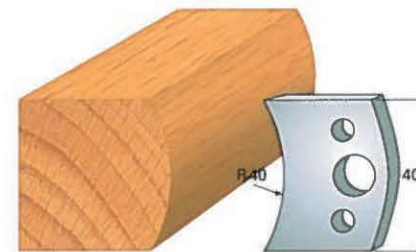

Art. SA0008 - (SA1008)

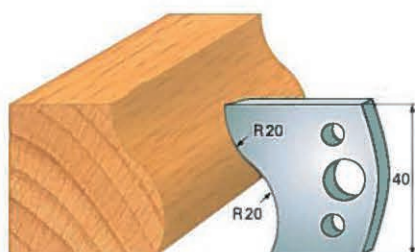

Art. SA0009 - (SA1009)

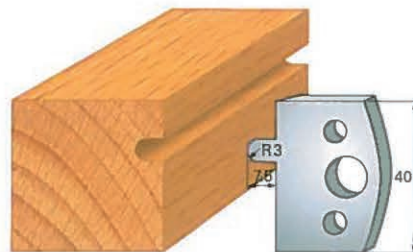

Art. SA0010 - (SA1010)

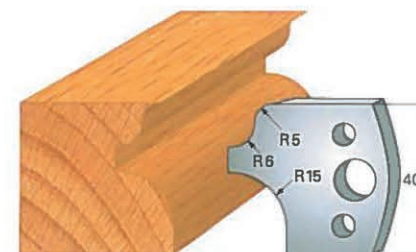

Art. SA0011 - (SA1011)

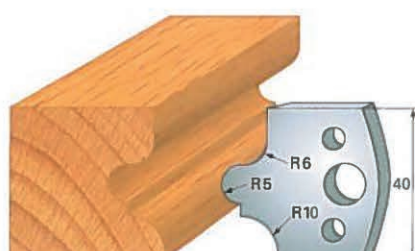

Art. SA0012 - (SA1012)

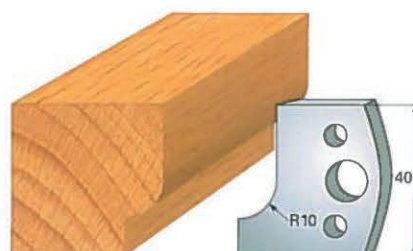

Art. SA0013 - (SA1013)

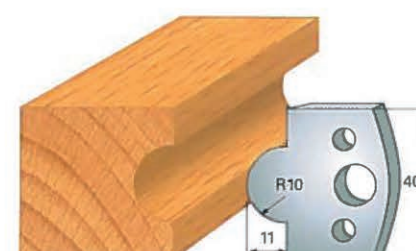

Art. SA0014 - (SA1014)

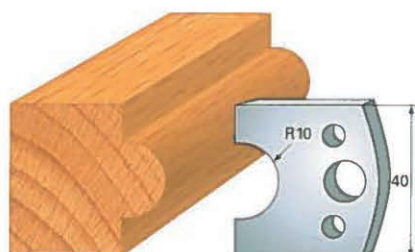

Art. SA0015 - (SA1015)

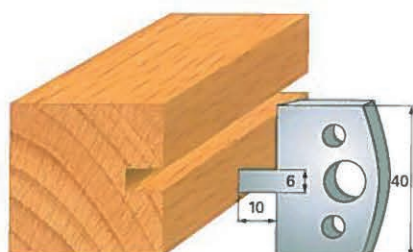

Art. SA0016 - (SA1016)



Art. SA0017 - (SA1017)

**STANDARD PROFILE KNIVES IN "SP" STEEL - height 40x4 mm
(RELATING LIMITERS)**

**Example:
Knife SA0..
Limiter (SA1..)**

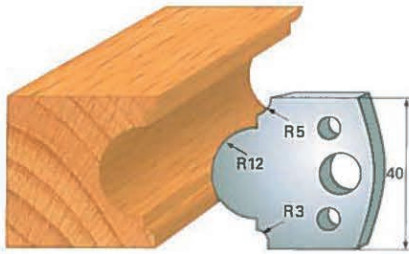

Art. SA0018 - (SA1018)

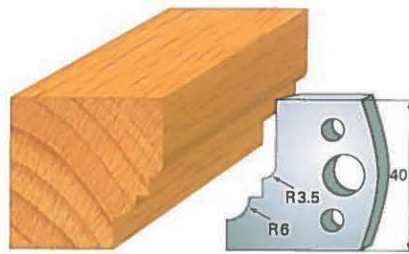

Art. SA0019 - (SA1019)

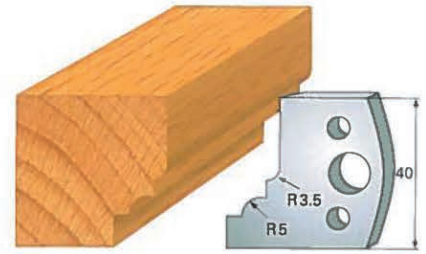

Art. SA0020 - (SA1020)

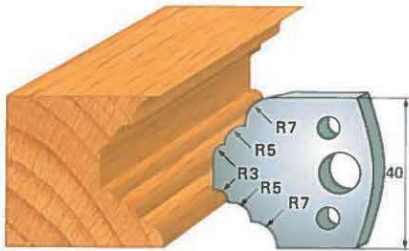

Art. SA0021 - (SA1021)

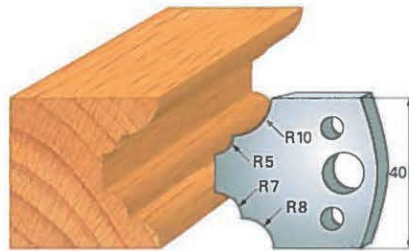

Art. SA0022 - (SA1022)

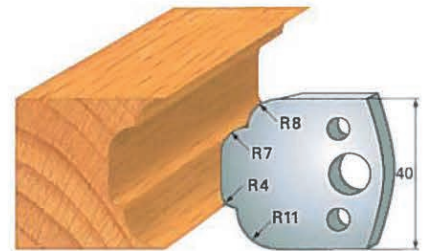

Art. SA0023 - (SA1023)

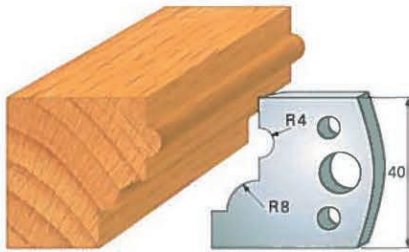

Art. SA0024 - (SA1024)

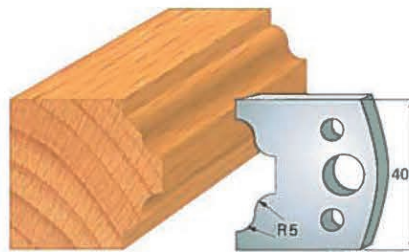

Art. SA0025 - (SA1025)

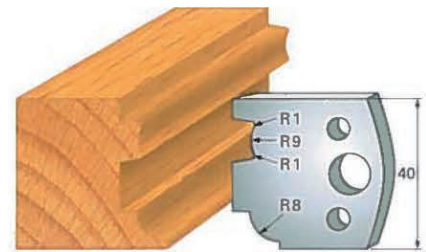

SA0026 - (SA1026)

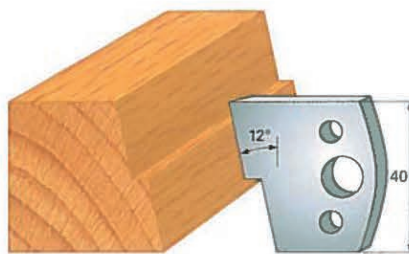

Art. SA0027 - (SA1027)



Art. SA0028 - (SA1028)

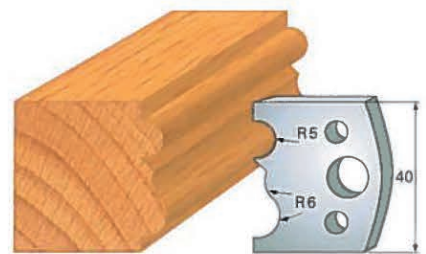

Art. SA0029 - (SA1029)

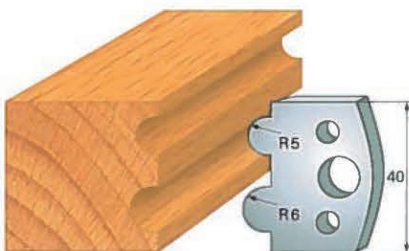

Art. SA0030 - (SA1030)

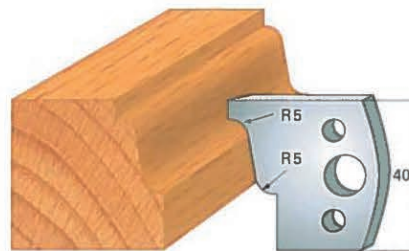

Art. SA0031 - (SA1031)

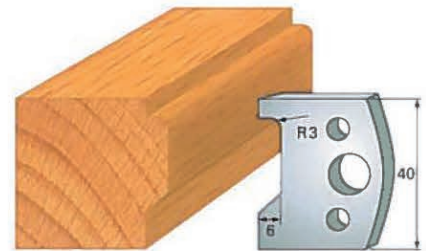

Art. SA0032 - (SA1032)

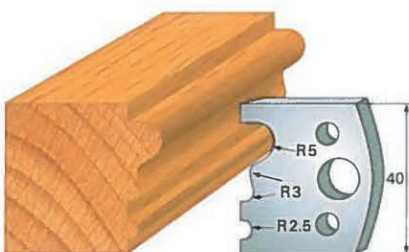

Art. SA0033 - (SA1033)

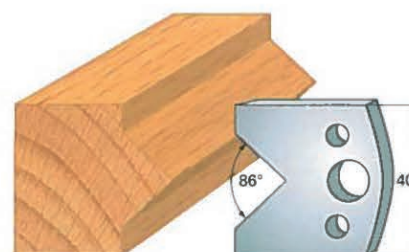

Art. SA0034 - (SA1034)

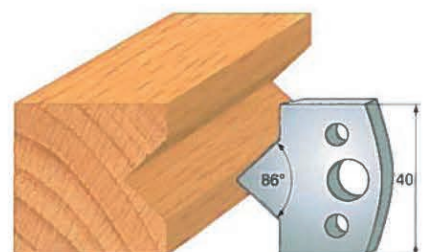

Art. SA0035 - (SA1035)

**STANDARD PROFILE KNIVES IN "SP" STEEL - height 40x4 mm
(RELATING LIMITERS)**

**Example:
Knife SA0..
Limiter (SA1..)**

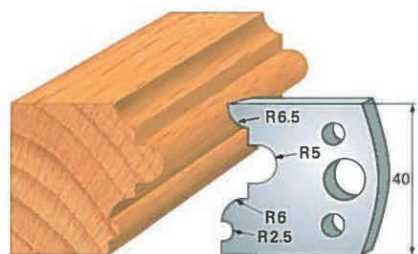

Art. SA0036 - (SA1036)

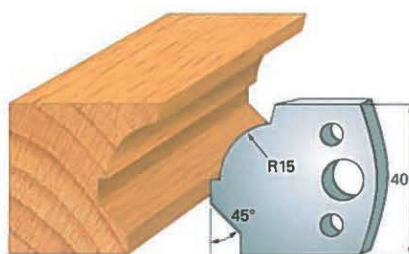

Art. SA0037 - (SA1037)

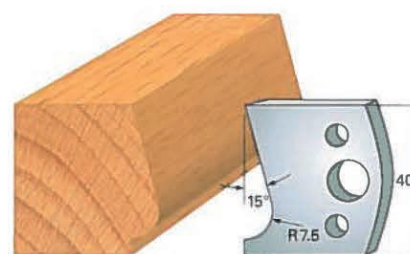

Art. SA0038 - (SA1038)

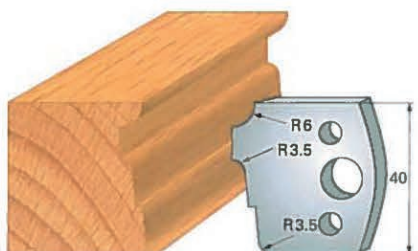

Art. SA0039 - (SA1039)

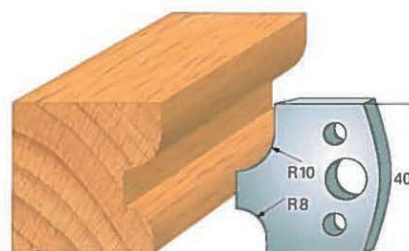

Art. SA0040 - (SA1040)

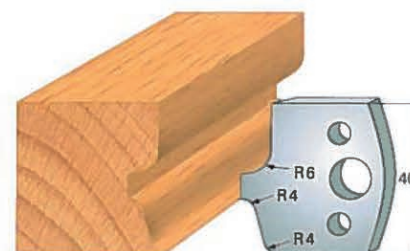

Art. SA0041 - (SA1041)

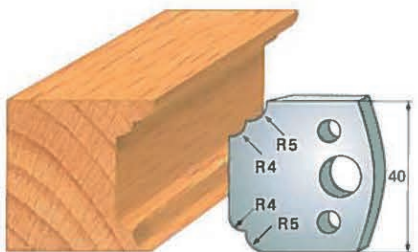

Art. SA0042 - (SA1042)

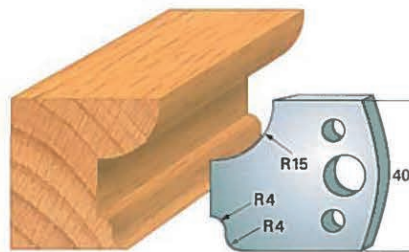

Art. SA0043 - (SA1043)

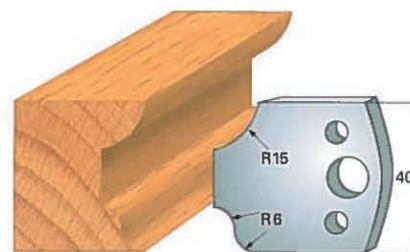

Art. SA0044 - (SA1044)

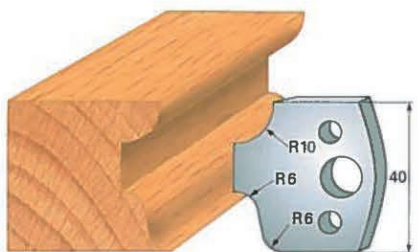

Art. SA0045 - (SA1045)

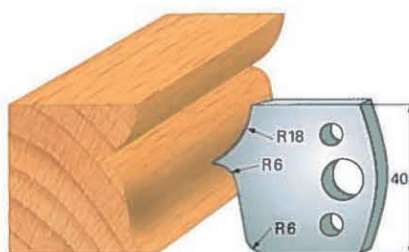

Art. SA0046 - (SA1046)

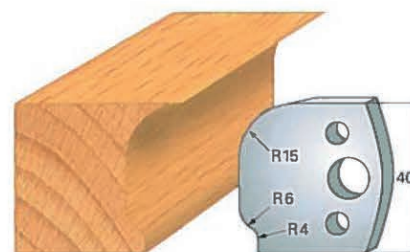

Art. SA0047 - (SA1047)

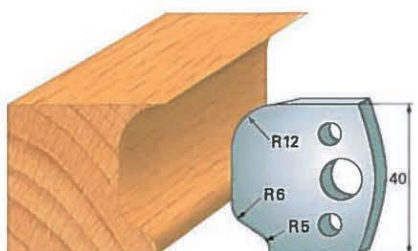

Art. SA0048 - (SA1048)

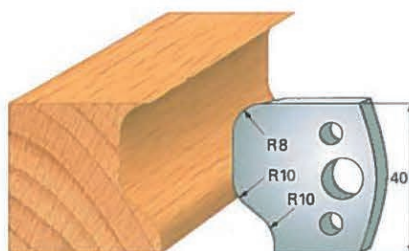

Art. SA0049 - (SA1049)

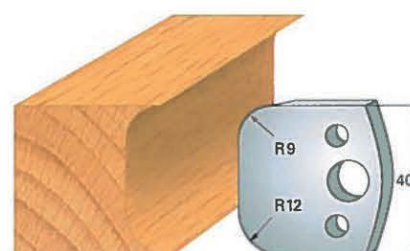

Art. SA0050 - (SA1050)

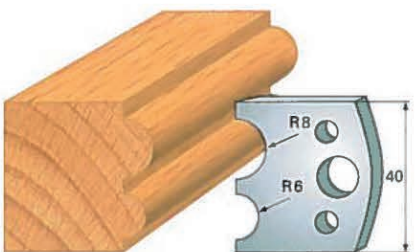

Art. SA0051 - (SA1051)

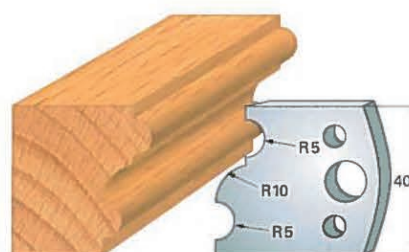

Art. SA0052 - (SA1052)

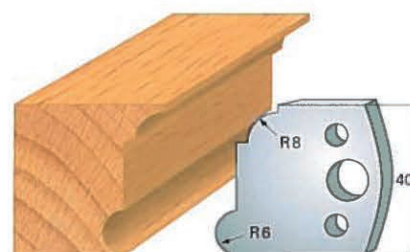

Art. SA0053 - (SA1053)

**STANDARD PROFILE KNIVES IN "SP" STEEL - height 40x4 mm
(RELATING LIMITERS)**

**Example:
Knife SA0..
Limiter (SA1..)**

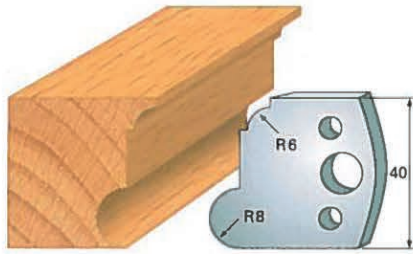

Art. SA0054 - (SA1054)

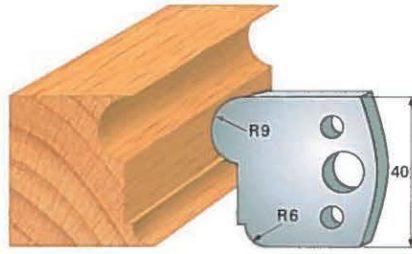

Art. SA0055 - (SA1055)

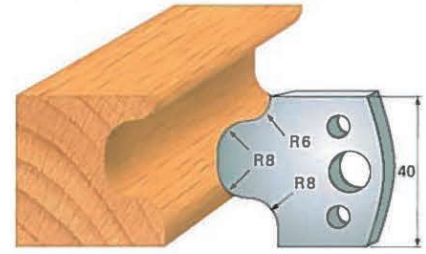

Art. SA0056 - (SA1056)

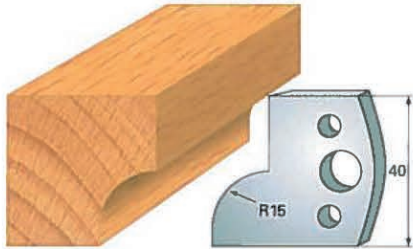

Art. SA0057 - (SA1057)

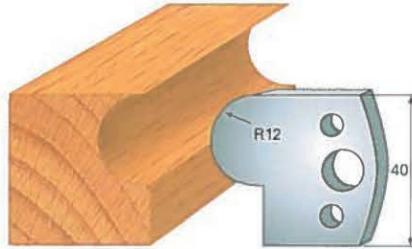

Art. SA0058 - (SA1058)

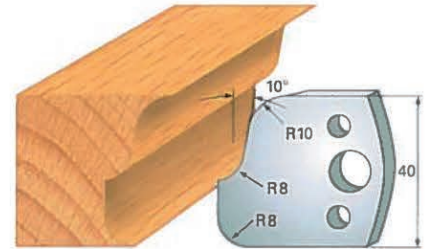

Art. SA0059 - (SA1059)

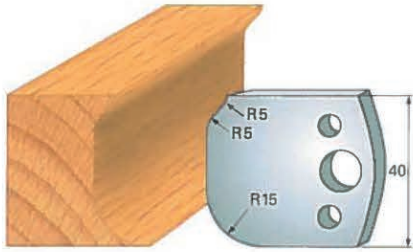

Art. SA0060 - (SA1060)

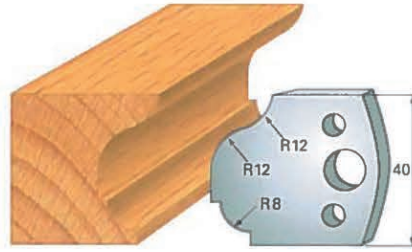

Art. SA0061 - (SA1061)

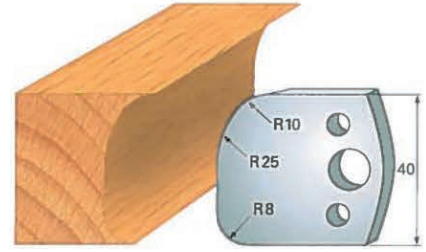

Art. SA0062 - (SA1062)

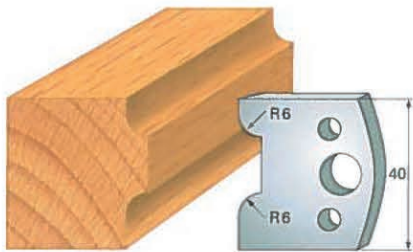

Art. SA0063 - (SA1063)

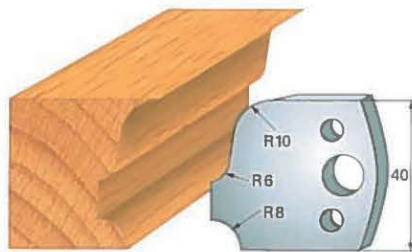

Art. SA0064 - (SA1064)

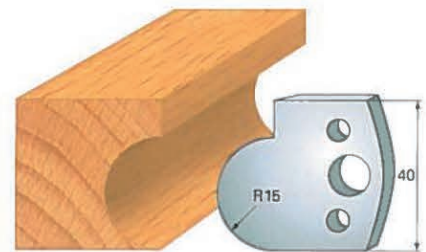

Art. SA0065 - (SA1065)

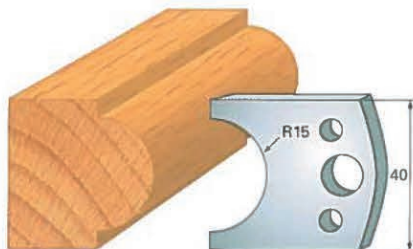

Art. SA0066 - (SA1066)

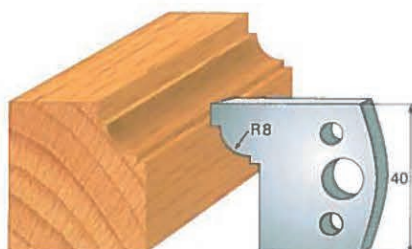

Art. SA0067 - (SA1067)

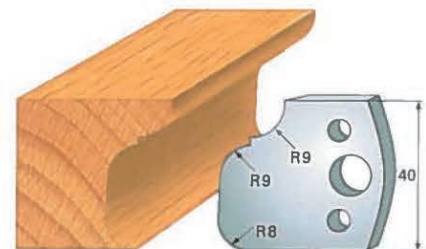

Art. SA0068 - (SA1068)

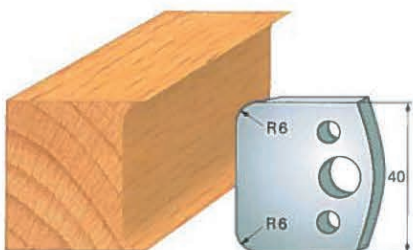

Art. SA0069 - (SA1069)

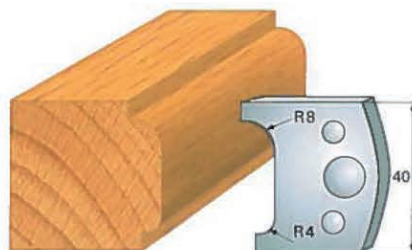

Art. SA0070 - (SA1070)

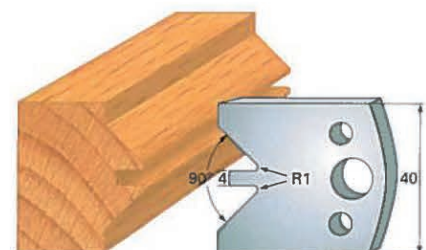

Art. SA0071 - (SA1071)

**STANDARD PROFILE KNIVES IN "SP" STEEL - height 40x4 mm
(RELATING LIMITERS)**

**Example:
Knife SA0..
Limiter (SA1..)**

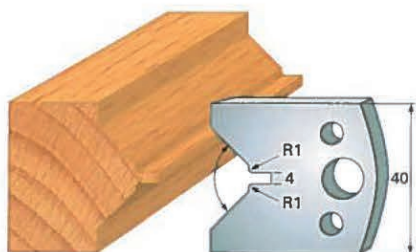

Art. SA0072 - (SA1072)

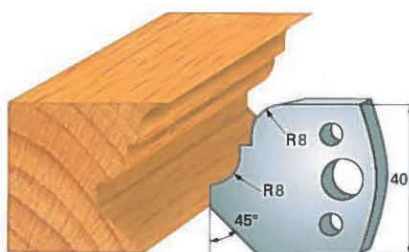

Art. SA0073 - (SA1073)

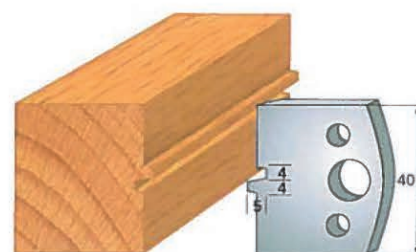

Art. SA0074 - (SA1074)

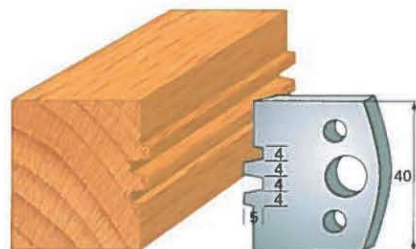

Art. SA0075 - (SA1075)

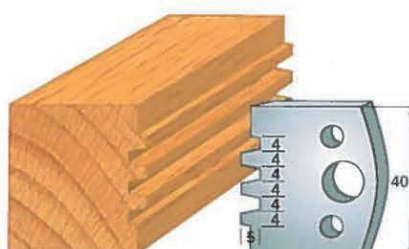

Art. SA0076 - (SA1076)

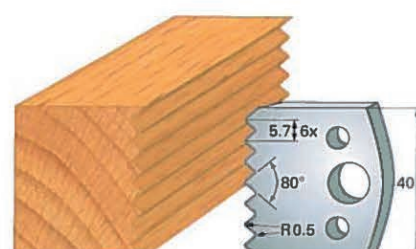

Art. SA0077 - (SA1077)

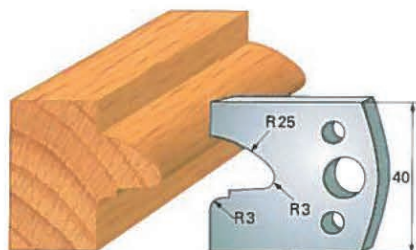

Art. SA0078 - (SA1078)

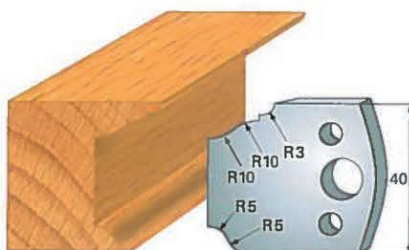

Art. SA0079 - (SA1079)

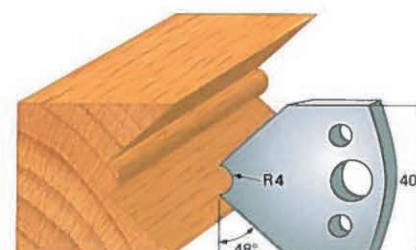

Art. SA0080 - (SA1080)

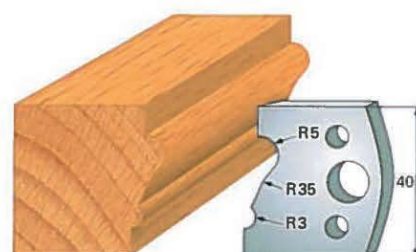

Art. SA0081 - (SA1081)

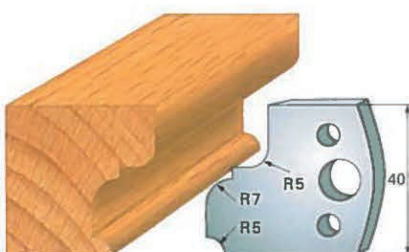

Art. SA0082 - (SA1082)

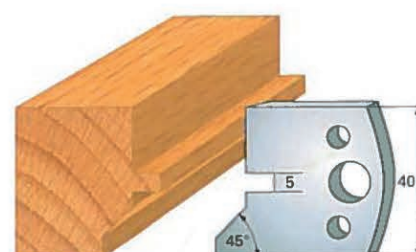

Art. SA0083 - (SA1083)

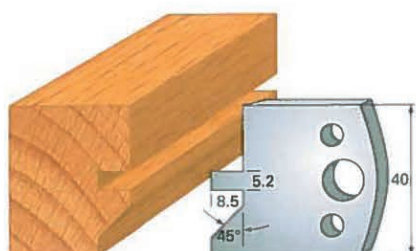

Art. SA0084 - (SA1084)

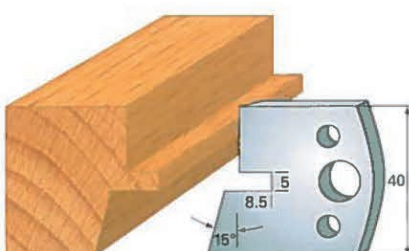

Art. SA0085 - (SA1085)

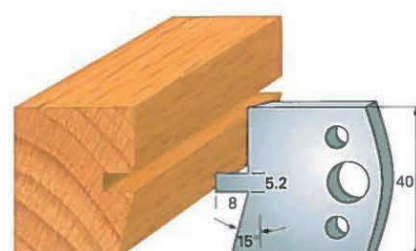

Art. SA0086 - (SA1086)

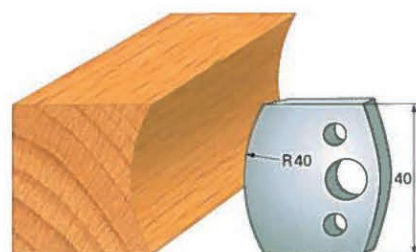

Art. SA0087 - (SA1087)

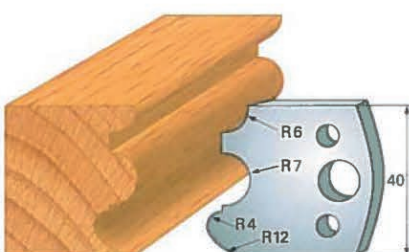

Art. SA0088 - (SA1088)

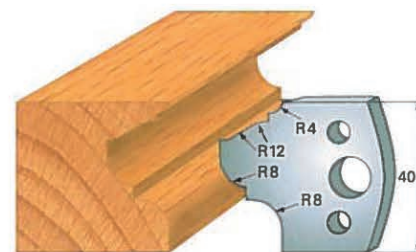

Art. SA0089 - (SA1089)

**STANDARD PROFILE KNIVES IN "SP" STEEL - height 40x4 mm
(RELATING LIMITERS)**

**Example:
Knife SA0..
Limiter (SA1..)**

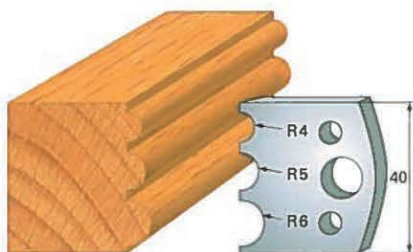

Art. SA0090 - (SA1090)

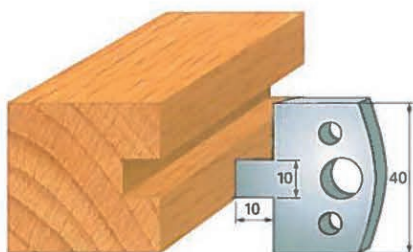

Art. SA0091 - (SA1091)

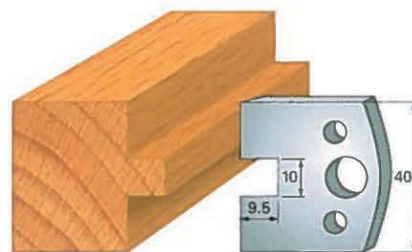

Art. SA0092 - (SA1092)

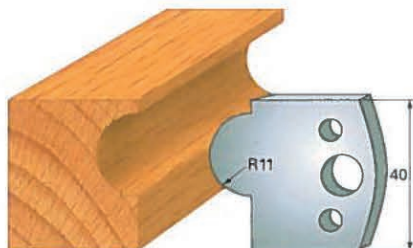

Art. SA0093 - (SA1093)

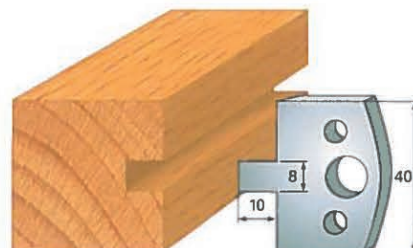

Art. SA0094 - (SA1094)

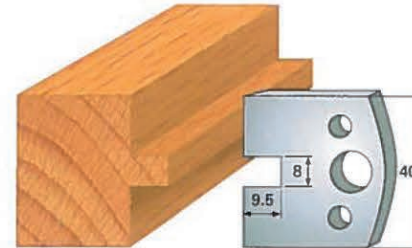

Art. SA0095 - (SA1095)

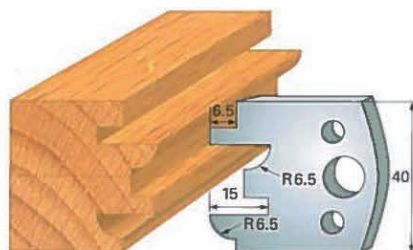

Art. SA0096 - (SA1096)

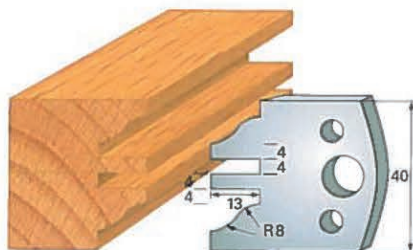

Art. SA0097 - (SA1097)

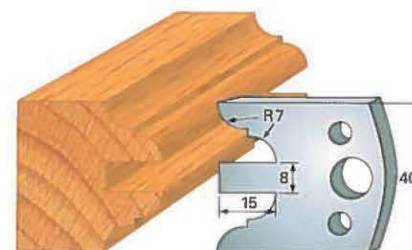

Art. SA0098 - (SA1098)

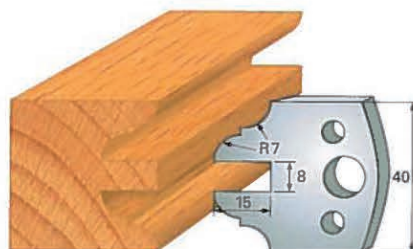

Art. SA0099 - (SA1099)

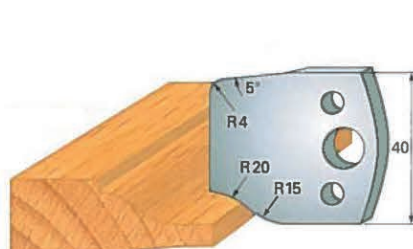

Art. SA0100 - (SA1100)

BLANK KNIVES AND LIMITERS IN "SP" STEEL

ART. SA

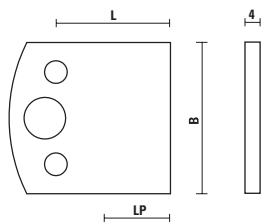

- They have to be sharpened within "LP" dimension
- Sold in pairs
- Full range at page 13.10

Item	B	L	C	LP	Type
SA000X	40	33,5	4	18	Knife
SA100X	38	32,5	4	18	Limiter
SA200X	50	34	4	20	Knife
SA300X	48	33	4	20	Limiter

**STANDARD PROFILE KNIVES IN "SP" STEEL - height 50x4 mm
(RELATING LIMITERS)**

**Example:
Knife SA2..
Limiter (SA3..)**

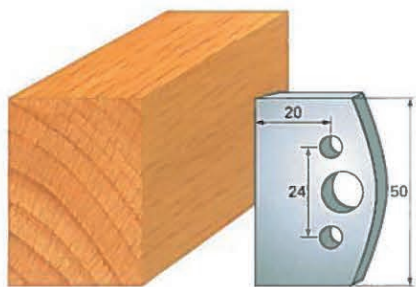

Art. SA2000 - (SA3000)

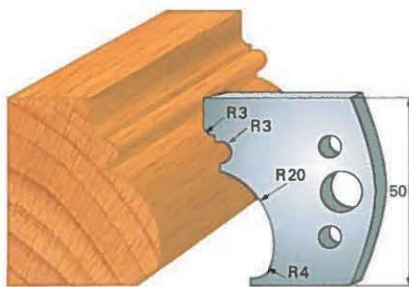

Art. SA2001 - (SA3001)

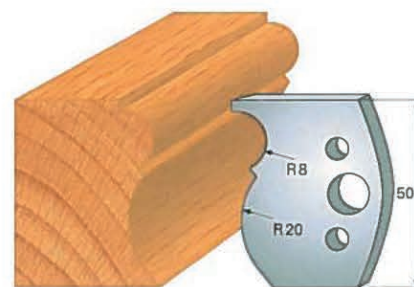

Art. SA2002 - (SA3002)

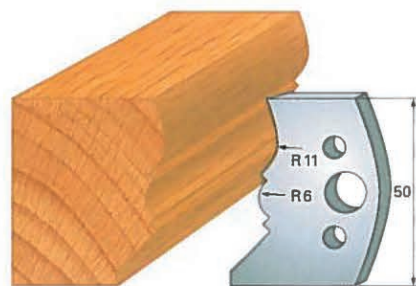

Art. SA2003 - (SA3003)

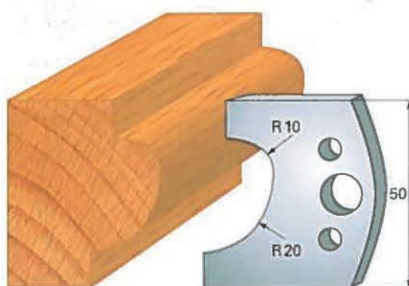

Art. SA2004 - (SA3004)

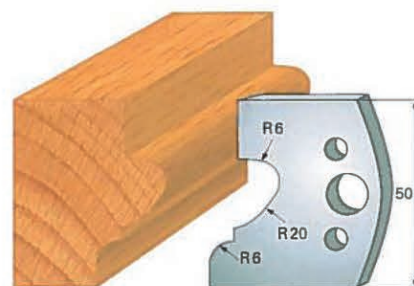

Art. SA2005 - (SA3005)

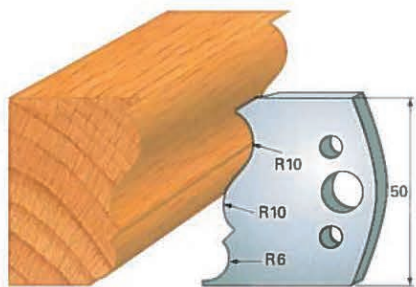

Art. SA2006 - (SA3006)

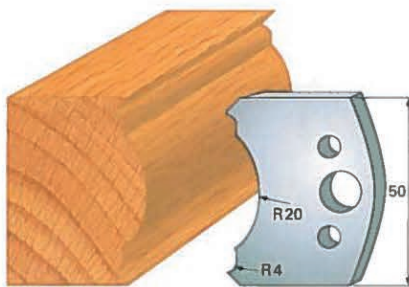

Art. SA2007 - (SA3007)

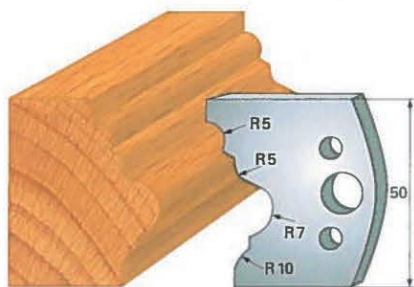

Art. SA2008 - (SA3008)

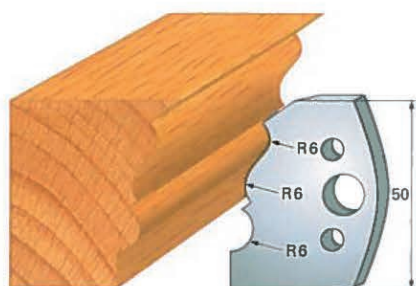

Art. SA2009 - (SA3009)

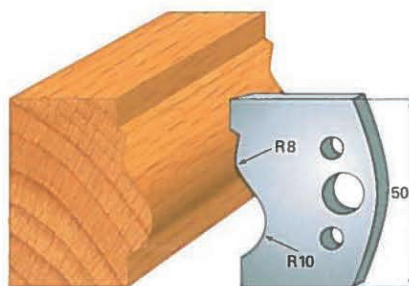

Art. SA2010 - (SA3010)

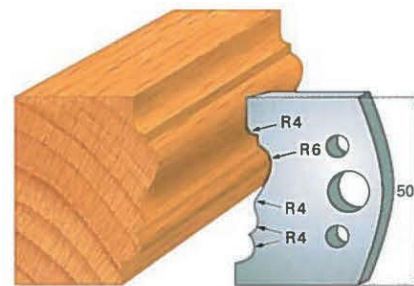

Art. SA2011 - (SA3011)

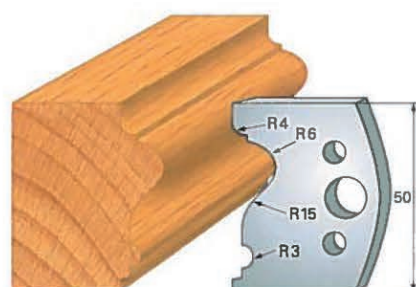

Art. SA2012 - (SA3012)

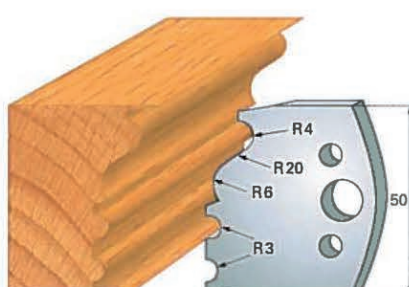

Art. SA2013 - (SA3013)

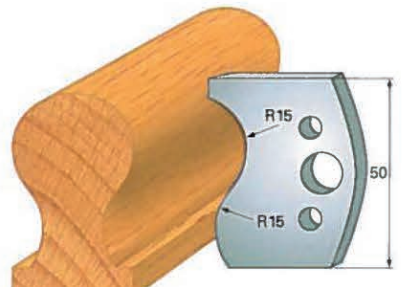

Art. SA2014 - (SA3014)

**STANDARD PROFILE KNIVES IN "SP" STEEL - height 50x4 mm
(RELATING LIMITERS)**

**Example:
Knife SA2..
Limiter (SA3..)**

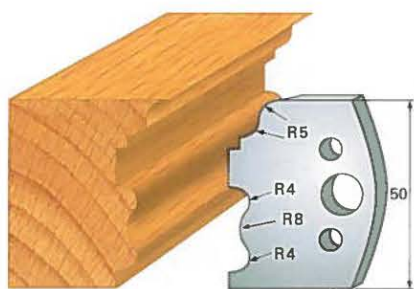

Art. SA2015 - (SA3015)

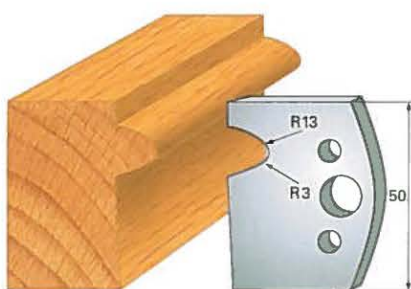

Art. SA2016 - (SA3016)

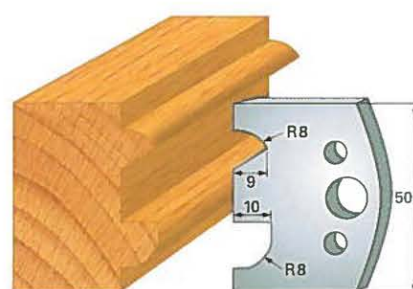

Art. SA2017 - (SA3017)

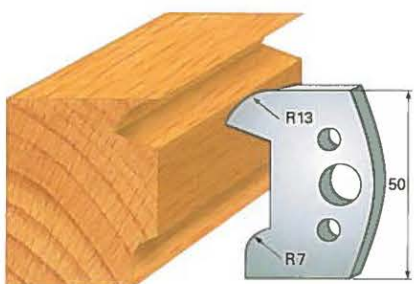

Art. SA2018 - (SA3018)

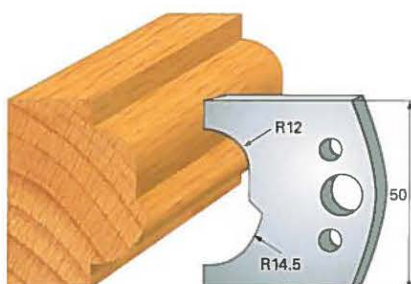

Art. SA2023 - (SA3019)

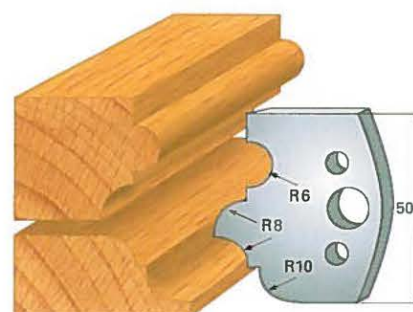

Art. SA2020 - (SA3020)

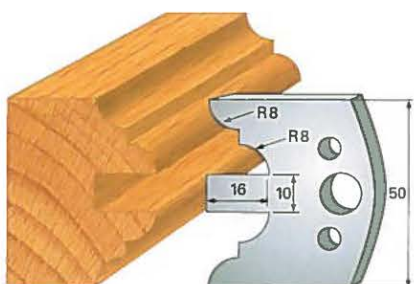

Art. SA2022 - (SA3022)

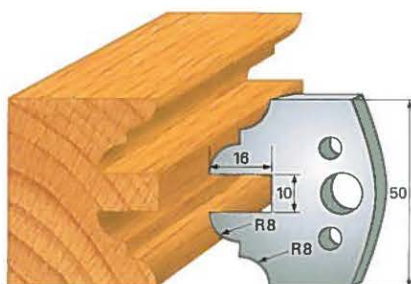

Art. SA2023 - (SA3023)

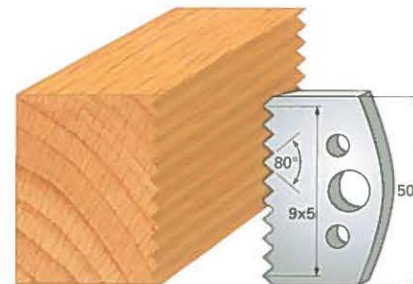

Art. SA2024 - (SA3024)



Art. SA2041 - (SA3041)

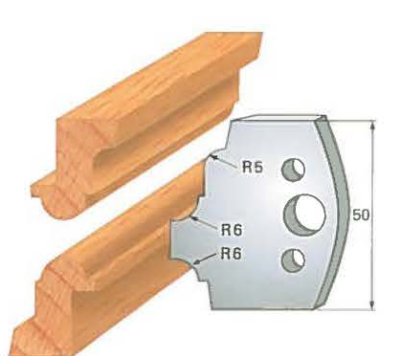

Art. SA2042 - (SA3042)

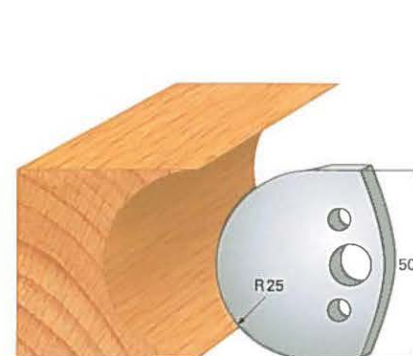

Art. SA2043 - (SA3043)



Art. SA2044 - (SA3044)



Art. SA2045 - (SA3045)

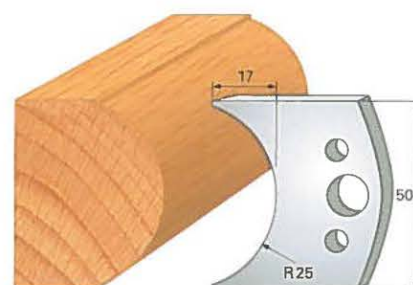

Art. SA2046 - (SA3046)

**STANDARD PROFILE KNIVES IN "SP" STEEL - height 50x4 mm
(RELATING LIMITERS)**

**Example:
Knife SA2..
Limiter (SA3..)**

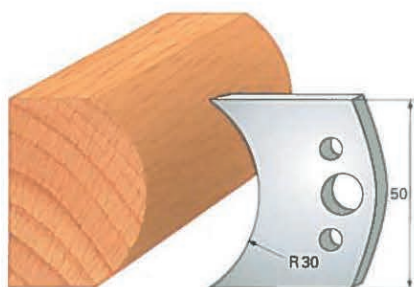

Art. SA2047 - (SA3047)



Art. SA2048 - (SA3048)

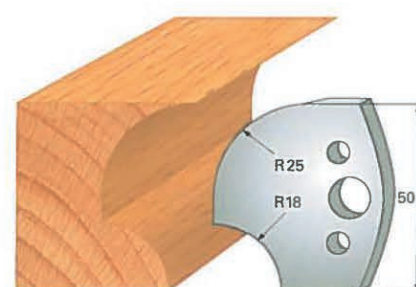

Art. SA2049 - (SA3049)

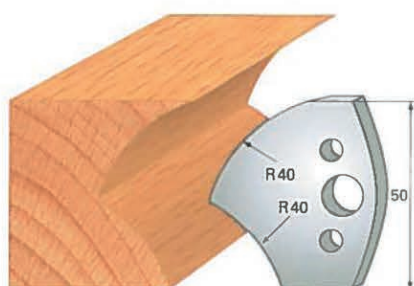

Art. SA2050 - (SA3050)

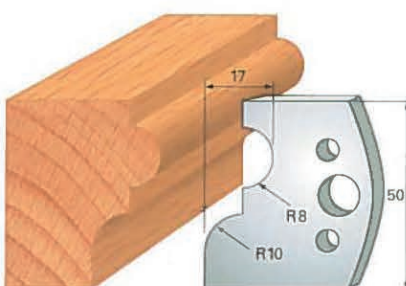

Art. SA2051 - (SA3051)

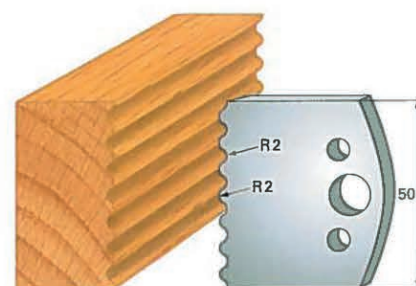

Art. SA2052 - (SA3052)

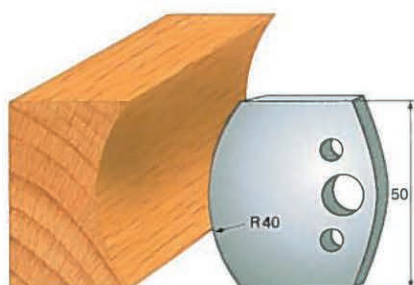

Art. SA2053 - (SA3053)

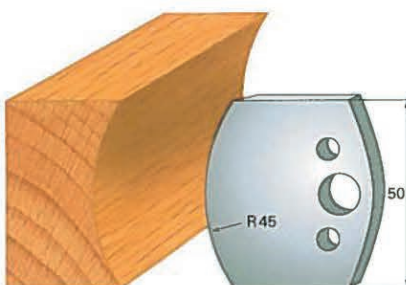

Art. SA2054 - (SA3054)

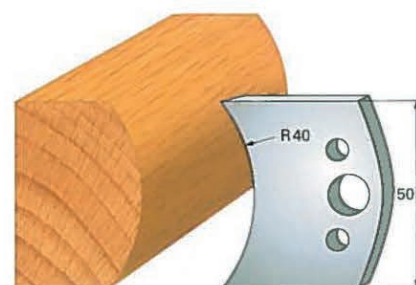

Art. SA2055 - (SA3055)

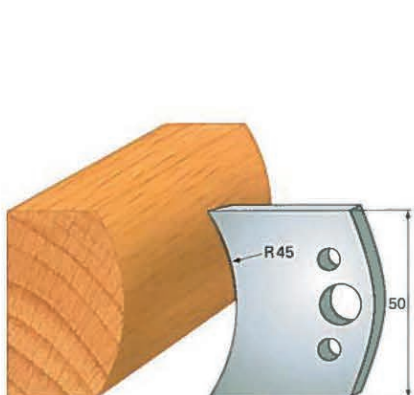

Art. SA2056 - (SA3056)

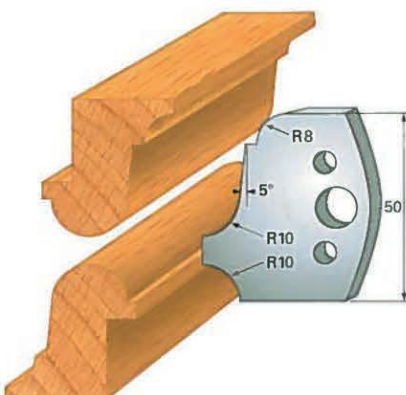

Art. SA2057 - (SA3057)

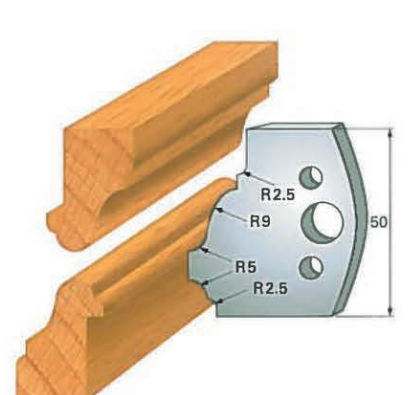

Art. SA2058 - (SA3058)

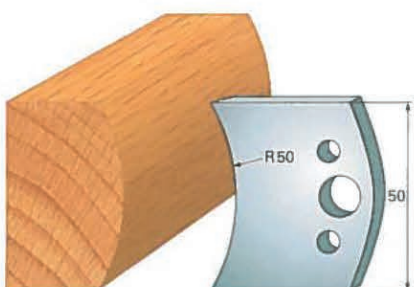

Art. SA2059 - (SA3059)

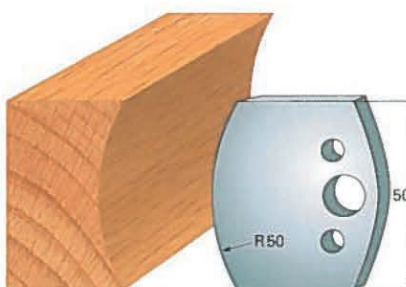

Art. SA2060

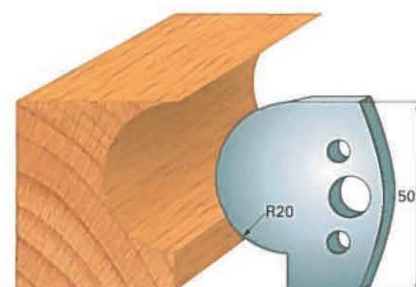

Art. SA2062 - (SA3062)

**STANDARD PROFILE KNIVES IN "SP" STEEL - height 50x4 mm
(RELATING LIMITERS)**

**Example:
Knife SA2..
Limiter (SA3..)**

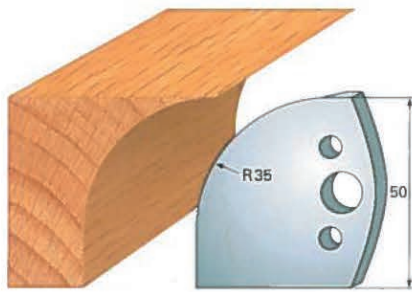

Art. SA2064

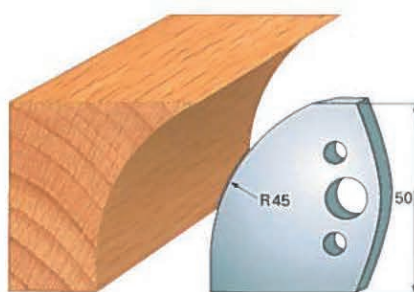

Art. SA2066

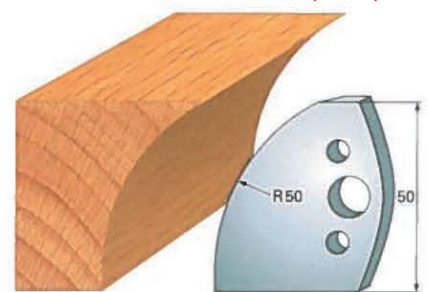

Art. SA2067

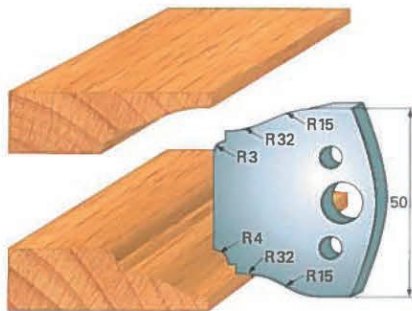

Art. SA2068 - (SA3068)

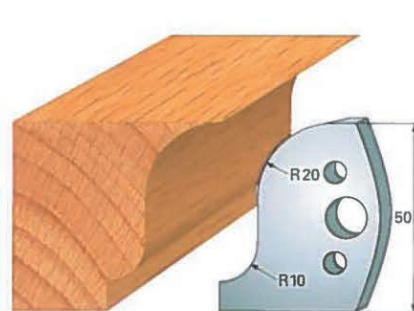

Art. SA2070



Art. SA2072 - (SA3072)

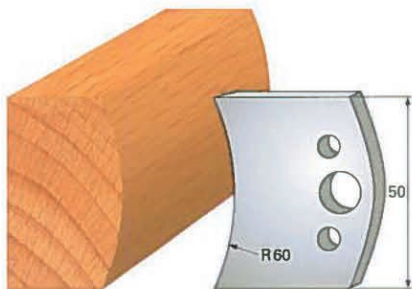

Art. SA2073 - (SA3073)

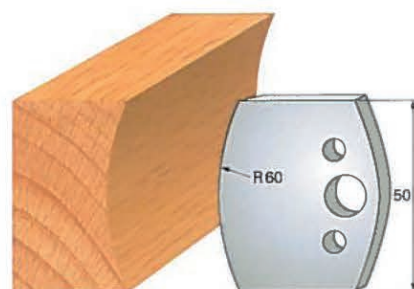

Art. SA2074

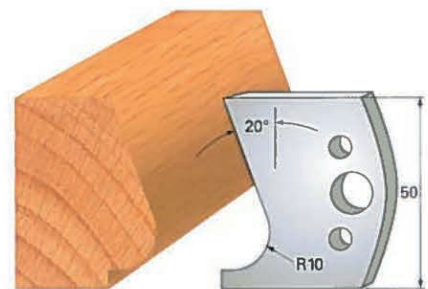

Art. SA2075 - (SA3075)

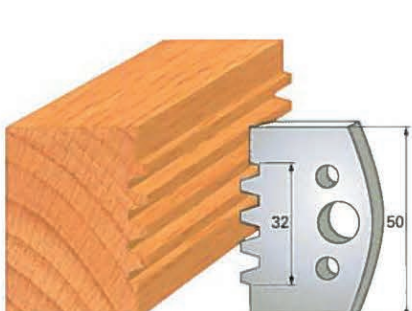

Art. SA2076 - (SA3076)

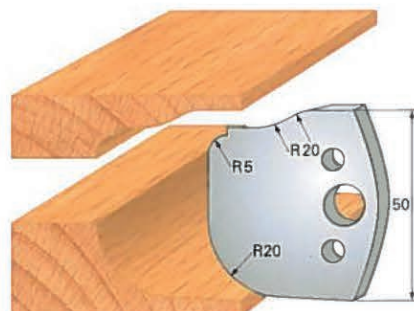

Art. SA2077

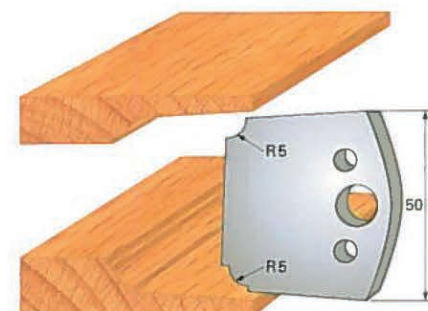

Art. SA2079

BLANK KNIVES AND LIMITERS IN "SP" STEEL

ART. SA

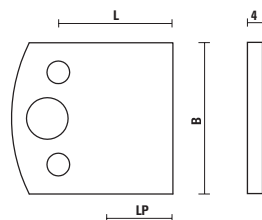

- They have to be sharpened within "LP" dimension
- Sold in pairs
- Full range at page 13.10

Item	B	L	C	LP	Type
SA000X	40	33,5	4	18	Knife
SA100X	38	32,5	4	18	Limiter
SA200X	50	34	4	20	Knife
SA300X	48	33	4	20	Limiter

HW ADJUSTABLE CUTTERHEAD WITH REVERSIBLE KNIVES FOR GROOVES

ART. TA

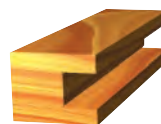
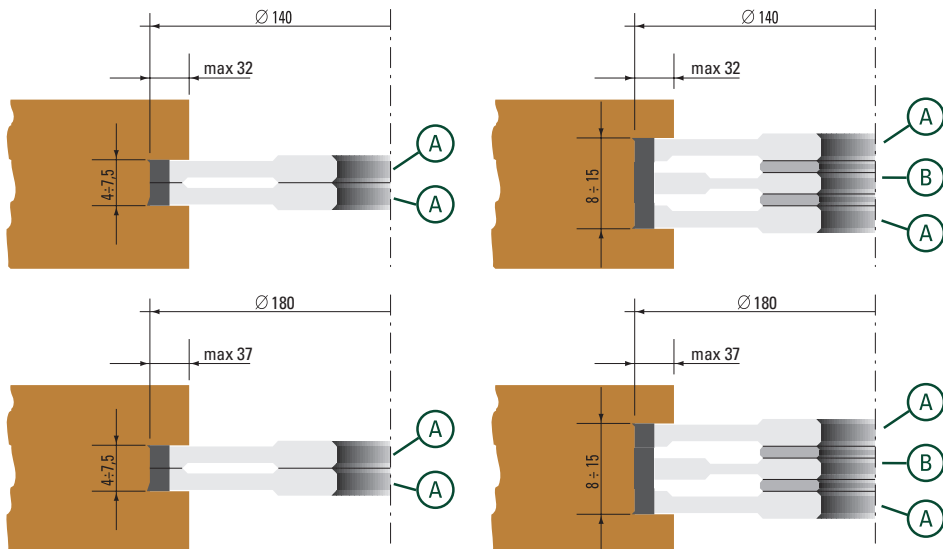

- For precision grooves 4 to 15 mm
- Adjustable by using spacer rings (included)
- Cutterhead in steel with reversible HW knives
- Manual feed (MAN)

Item	D	d	B	Z	V	Emax
TA140.07530 A+A	140	30	4÷7,5	4	4	32
TA140.07535 A+A	140	35	4÷7,5	4	4	32
TA140.07630 B	140	30	7,65	2	-	32
TA140.07635 B	140	35	7,65	2	-	32
TA140.15030 A+B+A	140	30	4÷15	4+2	4	32
TA140.15035 A+B+A	140	35	4÷15	4+2	4	32
TA180.07530 A+A	180	30	4÷7,5	8	4	37
TA180.07535 A+A	180	35	4÷7,5	8	4	37
TA180.07630 B	180	30	7,65	2	-	37
TA180.07635 B	180	35	7,65	2	-	37
TA180.15030 A+B+A	180	30	4÷15	8	4	37
TA180.15035 A+B+A	180	35	4÷15	8	4	37

Spare parts:	TA140.075		TA140.076	
	Dimensions	Item	Dimensions	Item
Knife	18x18x1,95	Z055.020.N	7,6x12x1,5	Z555.000.N
Knife screw	M4x3,2	Z051.700.R		
Threaded ring	12x1,7	Z060.701.R		
Spur	14x14x1,2	Z555.006.N		
Spur screw	M4x3,2	Z051.700.R		
Threaded ring	10x1,65	Z060.700.R		
Wedge	-	-	L=6,8	Z056.700.N
Wedge screw	-	-	M5x18	Z051.800.R

HW CUTTERHEADS WITH REVERSIBLE KNIVES FOR "LAMELLO®"

ART. TAH

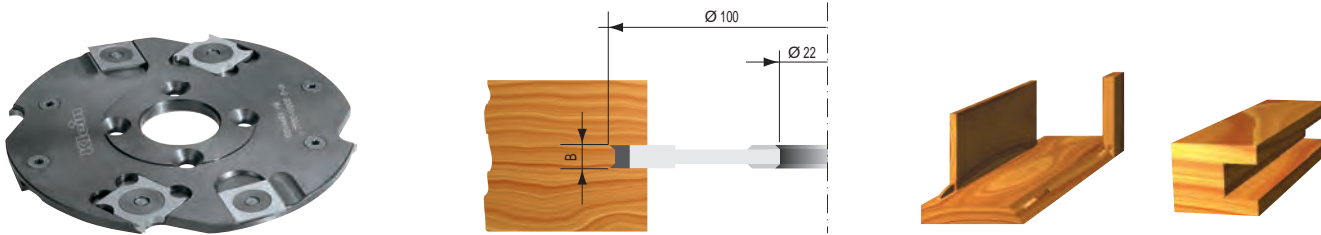

- For "Lamello®" biscuit jointers on any kind of wood
- Cutterhead in steel with reversible HW knives and spurs
- Manual feed (MAN)

Item	D	d	B	Z	V	Pin holes
TAH100.20622	100	22	4	4	4	4/4.3/36

Spare parts:

	Dimensions	Item
Knife	18x18x1,95	Z055.020.N
Knife screw	M4x3,2	Z051.700.R
Threaded ring	12x1,7	Z060.701.R
Spur	14x14x1,2	Z555.006.N
Spur screw	M4x3,2	Z051.700.R
Threaded ring	10x1,65	Z060.700.R

HW ADJUSTABLE CUTTERHEAD WITH REVERSIBLE KNIVES FOR GROOVES

ART. TB

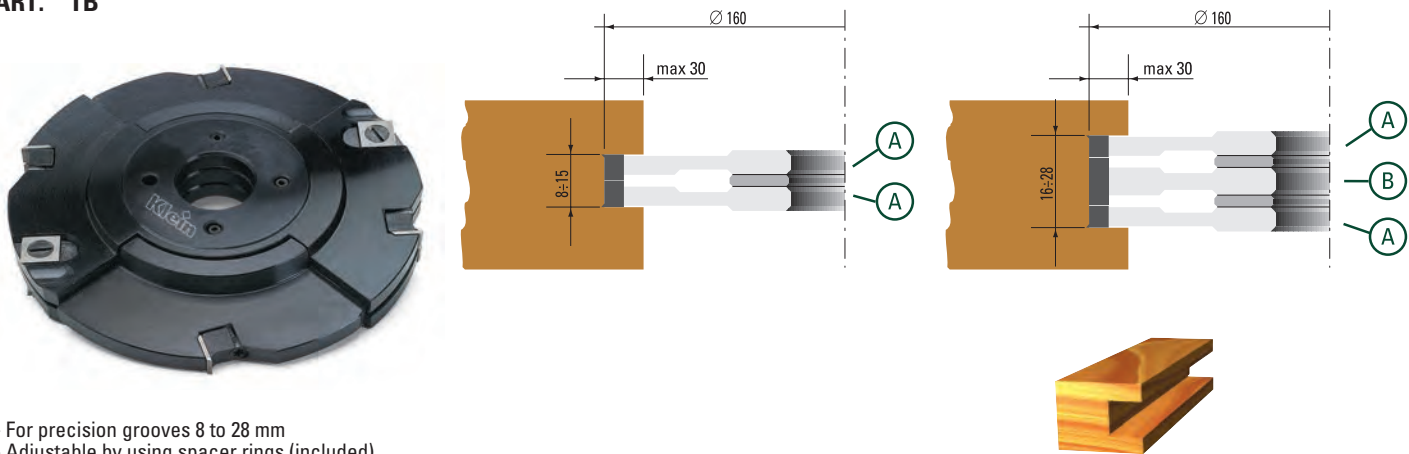

- For precision grooves 8 to 28 mm
- Adjustable by using spacer rings (included)
- Cutterhead in steel with reversible HW knives
- Manual feed (MAN)

Item	D	d	B	Z	V	E _{max}
TB160.15030 A+A	160	30	8÷15	4	4	30
TB160.15035 A+A	160	35	8÷15	4	4	30
TB160.15040 A+A	160	40	8÷15	4	4	30
TB160.15130 B	160	30	15	2	-	30
TB160.15135 B	160	35	15	2	-	30
TB160.15140 B	160	40	15	2	-	30
TB160.28030 A+B+A	160	30	8÷28	4+2	4	30
TB160.28035 A+B+A	160	35	8÷28	4+2	4	30
TB160.28040 A+B+A	160	40	8÷28	4+2	4	30

Spare parts:

	Dimensions	TB160.150	Dimensions	TB160.151
Knife	7,65x12x1,5	Z555.000.N	15x12x1,5	Z555.002.N
Wedge	L=6,8	Z056.700.N	L=14	Z056.701.N
Wedge screw	M5x18	Z051.800.R	M7x21	Z051.801.R
Spur	14x14x2	Z055.007.N		
Spur screw	M5x7	Z051.701.R		

HW ADJUSTABLE GROOVING CUTTERHEAD FOR TENONS

ART. TC

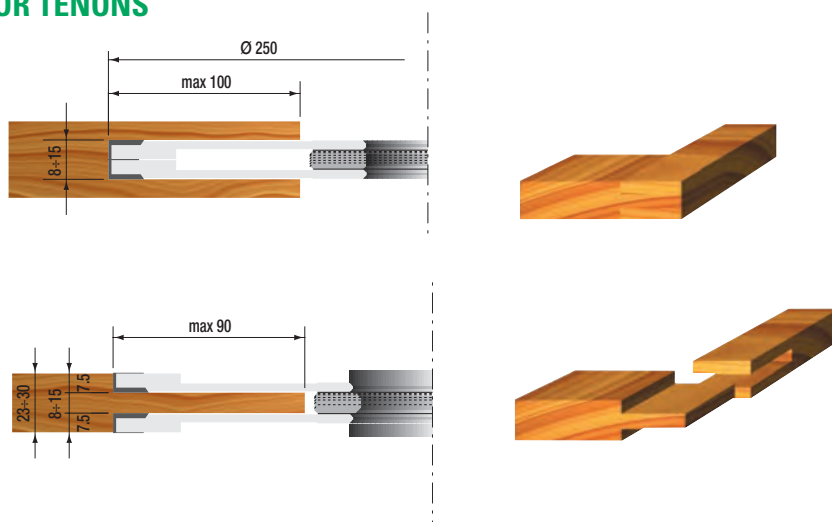

- For precision tenons 8 to 15 mm
- Adjustable by using spacer rings (included)
- Cutterhead in steel with reversible HW knives and spurs
- Manual feed (MAN)

Item	D	d	B	Z	V	Emax
TC250.15030	250	30	8÷15	4	4	100

Spare parts:

	Dimensions	Item
Knife	7,6x12x1,5	Z555.000.N
Wedge	L=6,8	Z056.700.N
Wedge screw	M5x18	Z051.800.R
Spur	14x14x2	Z055.007.N
Spur screw	M5x7	Z051.701.R

HW CUTTERHEAD WITH REVERSIBLE STRAIGHT KNIVES AND SPURS

ART. TEL



- Cutterhead for precision rebating straight cut, shear angle
- Light alloy with reversible HW knives and spurs
- Manual feed (MAN)

Item	D	d	B	Z	V
TEL100.50030	100	30	50	2	4
TEL100.50035	100	35	50	2	4
TEL125.50040	125	40	50	2	4
TEL125.50050	125	50	50	2	4

Spare parts:

	Dimensions	Item
Knife	50x12x1,5	Z055.010.N
Wedge	L=48	Z056.732.N
Wedge screw	M8x16	Z051.810.R
Spur	14x14x2	Z055.007.N
Spur screw	M5x7	Z051.701.R

HW CUTTERHEAD WITH REVERSIBLE STRAIGHT KNIVES AND SPURS

ART. TF

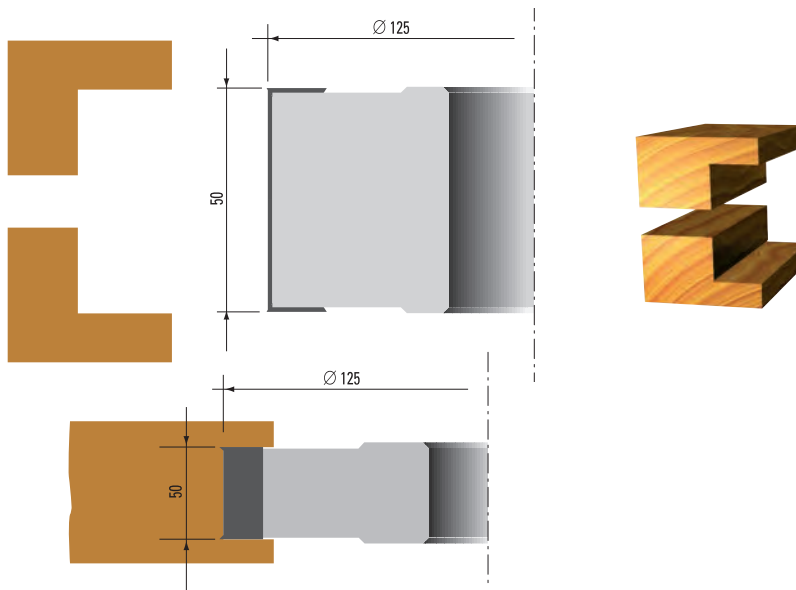

- Cutterhead for precision rebating straight cut, shear angle
- Steel body with reversible HW knives and spurs
- Manual feed (MAN)

Item	D	d	B	Z	V
TF125.50130	125	30	50	4	4
TF125.50135	125	35	50	4	4
TF125.50140	125	40	50	4	4
TF125.50150	125	50	50	4	4

Spare parts:		TF125.300		TF125.500	
	Dimensions	Item	Dimensions	Item	
Knife	30x12x1,5	Z555.008.N.N	50x12x1,5	Z555.010.N	
Wedge	L=26	Z056.703.N	L=46	Z056.702.N	
Wedge screw	M7x21	Z051.801.R	M7x21	Z051.801.R	
Spur	14x14x2	Z555.007.N	14x14x2	Z555.007.N	
Spur screw	M5x7	Z051.701.R	M5x7	Z051.701.R	

HW INSERT RABBETING CUTTER HEADS Z=2+2

ART. TGL

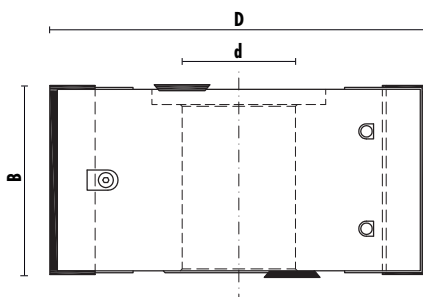

- Cutterhead for precision rebating straight cut, joints and groove
- Light alloy with reversible HW knives and spurs
- Manual feed (MAN)
- Complete with key for wedge and spur

Item	D	d	B	Z	V
TGL100.50030	100	30	50	2	2
TGL120.50030	120	30	50	2	2

Spare parts:		Dimensions	Item
Knife		50x12x1,5	Z055.010.N
Spur		14x14x2	Z555.007.N
Spur screw		M5x7 - T15	Z051.701.R
Wedge		L=48	Z056.728.N
Wedge screw		M8x20	Z051.813.R
Key		T15	Z052.201.N
Key		Hexagon 4	Z052.003.N

HW CUTTERHEAD FOR 45° BEVELS

ART. THL

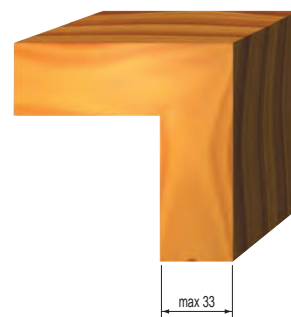
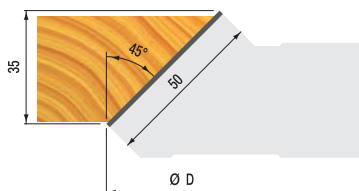

- Light alloy body for extremely accurate 45° bevels
- Reversible HW knives
- Manual feed (MAN)

Item	D	d	B	Z
THL150.36030	150	30	36	2
THL150.36035	150	35	36	2

Spare parts:

	Dimensions	Item
Knife	50x12x1,5	Z055.010.N
Wedge	-	Z056.704.N
Wedge stop	-	Z056.800.N
Screw	M8x21	Z051.802.R

HW ADJUSTABLE BEVEL CUTTERHEAD

ART. TI

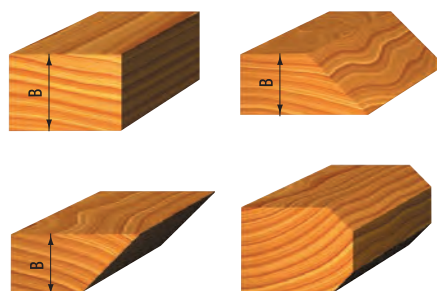
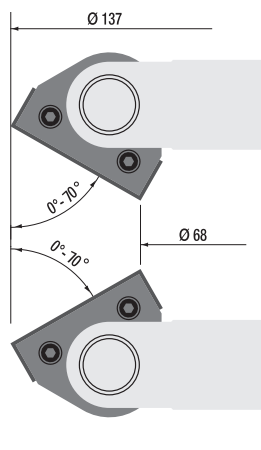

- Bevel cutterhead, adjustable by 1° on a scale
- Adjustment + 70° - 70°
- Steel tool body with HW reversible knives
- Manual feed (MAN)

Item	D	d	B	Z	α
TI160.50030	160	30	50	2	0+70°/0-70°
TI160.50035	160	35	50	2	0+70°/0-70°
TI160.50040	160	40	50	2	0+70°/0-70°
TI170.50050	170	50	50	2	0+70°/0-70°

Spare parts:	T1160.500	
	Dimensions	Item
Knife	50x12x1,5	Z555.010.N
Wedge	L=47	Z056.706.N
Wedge screw	M6x12	Z051.804.R

HW ADJUSTABLE BEVEL CUTTERHEAD

ART. TIL

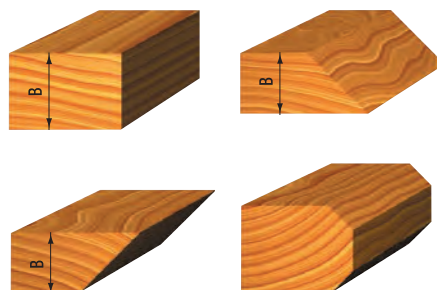
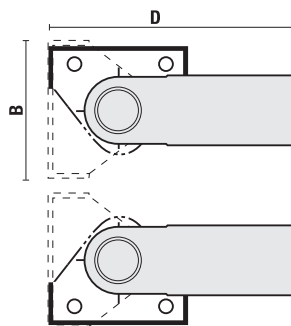

- Inclination between 0° and 90°
- Bevel cutterhead adjustable every 7,5°
- Produced in light alloy complete with HW knives
- Manual feed (MAN)

Item	D	d	B	Z
TIL140.50030	140	30	50	2
TIL140.50035	140	35	50	2
TIL160.50040	160	40	50	2
TIL160.50050	160	50	50	2

Spare parts:	T1160.500	
	Dimensions	Item
Knife	50x12x1,5	Z555.010.N
Wedge screw	M4x10 - Torx T15	Z051.811.R

HW TOOLING SET FOR ROUNDING AND CHAMFERING

ART. TLL

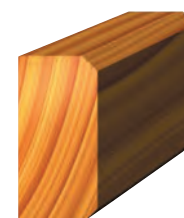
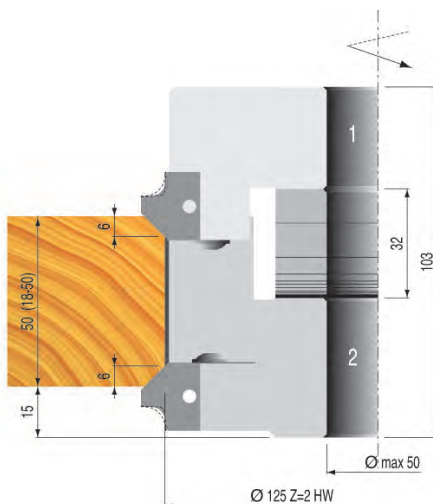
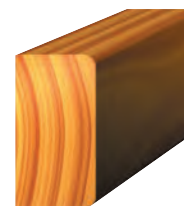
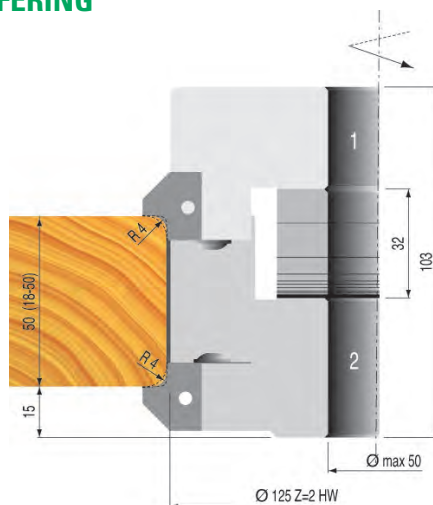

- Set of cutterhead for round profiles (R=2-3-4-5-6) on one side and 45° chamfer on the other
- Produced in light alloy complete with HW replaceable knives, spacing rings and two flanges for manual feeding
- Available also with bore 35/40/50

Item	D	d	B	Z	R	α
TLL139.50230	139	30	15÷50	2	2	45°
TLL139.50330	139	30	15÷50	2	3	45°
TLL139.50430	139	30	15÷50	2	4	45°
TLL139.50530	139	30	15÷50	2	5	45°
TLL139.50630	139	30	15÷50	2	6	45°

TLL139 diameter 139 mm. bore 35 mm. (code number ends with 35 instead of 30)

TLL139 diameter 139 mm. bore 40 mm. (code number ends with 40 instead of 30)

TLL139 diameter 139 mm. bore 50 mm. (code number ends with 50 instead of 30)

Spare parts:

	Dimensions	Item
Knife	50x12x1,5	Z555.010.N
Wedge	-	Z056.707.N
Wedge screw	M8x20	Z051.805.R
Top profile knife	R=2/45°	Z055.800.R
Bottom profile knife	R=2/45°	Z055.800.L
Top profile knife	R=3/45°	Z055.801.R
Bottom profile knife	R=3/45°	Z055.801.L
Top profile knife	R=4/45°	Z055.802.R
Bottom profile knife	R=4/45°	Z055.802.L
Top profile knife	R=5/45°	Z055.803.R
Bottom profile knife	R=5/45°	Z055.803.L
Top profile knife	R=6/45°	Z055.804.R
Bottom profile knife	R=6/45°	Z055.804.L
Wedge	-	Z056.708.N
Wedge screw	M8x20	Z051.805.R

HW MULTIRADIUS SET

ART. TML

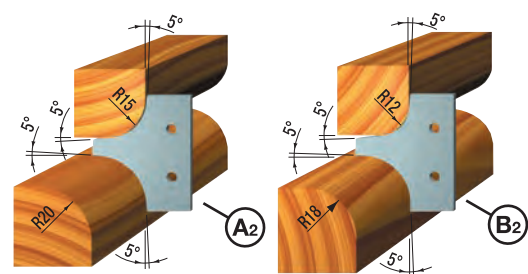
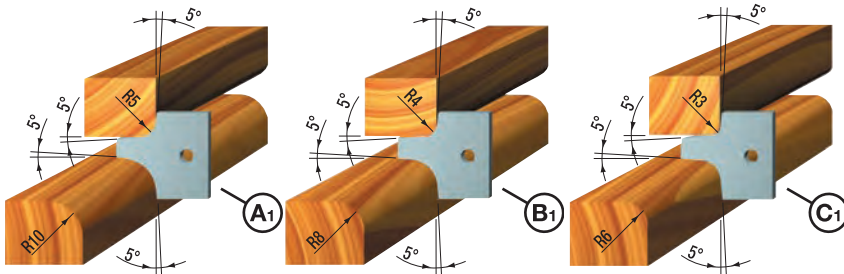
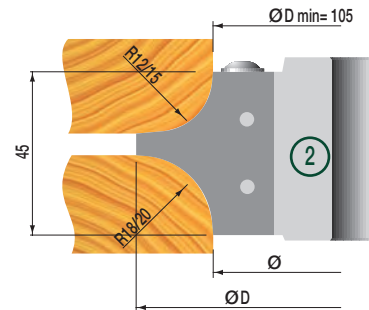
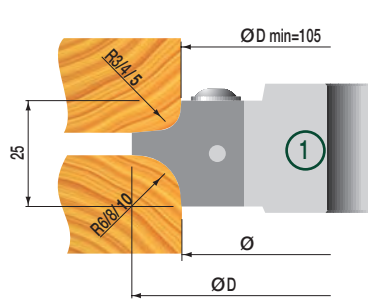

- Cutterhead with two radius knives mounted on the tools
- Produced in light alloy with HW knives
- Manual feed (MAN)
- Available also with bore 35

Item	D	d	B	Z	R
TML113.25330	128	30	25	2	3/6
TML113.25430	128	30	25	2	4/8
TML113.25530	128	30	25	2	5/10

TML113 diameter 128 mm. bore 35 mm. (code number ends with 35 instead of 30)

TML132.45230	147	30	45	2	12/18
TML132.45530	147	30	45	2	15/20

TML132 diameter 147 mm. bore 35 mm. (code number ends with 35 instead of 30)

Spare parts:	TML113.25		TML132.45	
	Dimensions	Item	Dimensions	Item
Profile knife	R= 3/6 C1	Z055.805.R	R= 12/18 B2	Z055.808.R
Profile knife	R= 4/8 B1	Z055.806.R	R= 15/20 A2	Z055.809.R
Profile knife	R= 5/10 A1	Z055.807.R	-	-
Wedge	-	Z056.709.N	-	Z056.710.N
Wedge screw	M8x20	Z051.805.R	M8x20	Z051.805.R



Art. **TX0002** complete with: **TML113.25330** +
2 pcs. Z055.806.R +
2 pcs. Z055.807.R

Art. **TX0003** complete with: **TML132.45230** +
2 pcs. Z055.808.R
2 pcs. Z055.809.R

Available with bore 35

Item	Description
TX0002	Set in plastic box complete with cutterhead + 2 profile knives each R= 3/6 + R= 4/8 + R= 5/10 (bore 35 on request)
TX0003	Set in plastic box complete with cutterhead + 2 profile knives each R= 12/18 + R= 15/20 (bore 35 on request)

HW TOOLING SET FOR CONCAVE AND CONVEX QUARTER ROUNDS

ART. TNL

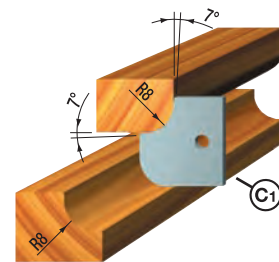
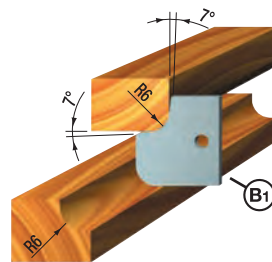
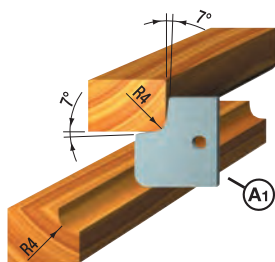
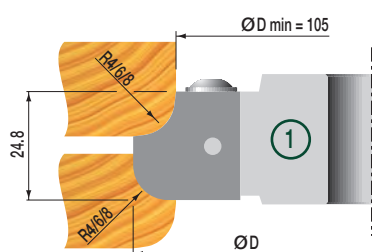

- Cutterhead with two radius knives mounted on the tools
- Produced in light alloy with HW knives
- Manual feed (MAN)
- Available also with bore 35

Item	D	d	B	Z	R
TNL110.25430	123	30	24,8	2	4-4
TNL110.25630	123	30	24,8	2	6-6
TNL110.25830	123	30	24,8	2	8-8

Spare parts: **TNL110.25**

	Dimensions	Item
Profile knife	R= 4/4 A1	Z055.810.R
Profile knife	R= 6/6 B1	Z055.811.R
Profile knife	R= 8/8 C1	Z055.812.R
Wedge	-	Z056.710.N
Wedge screw	M8x20	Z051.805.R



Art. **TX0004** complete with: **TNL110.25430** +
2 pcs. Z055.811.R +
2 pcs. Z055.812.R

Item	Description
TX0004	Set in plastic box complete with cutterhead + 2 profile knives each R= 4/4 + R= 6/6 + R= 8/8 (bore 35 on request)

MULTIPROFILE SET

ART. TX



TO CHECK ALL THE PROFILES

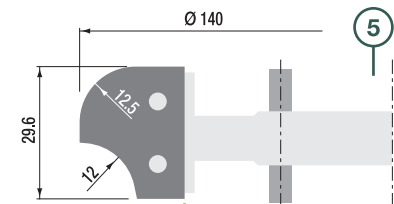
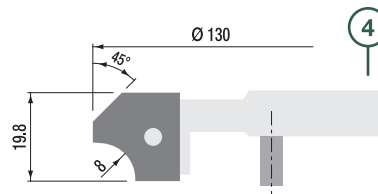
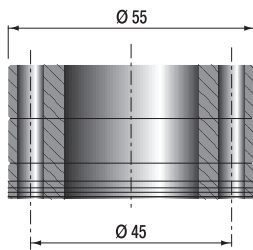
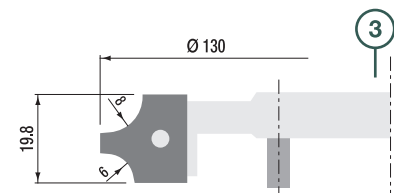
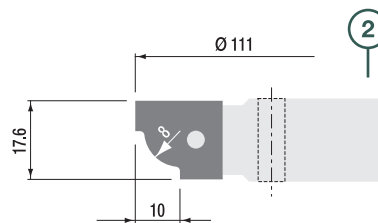
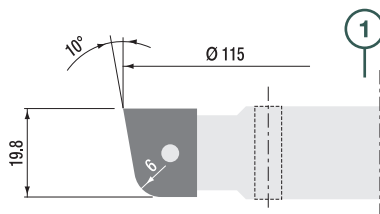

- Set complete with 5 heads in light alloy, Z=2 with HW knives and spacer rings
- For various profiles
- Manual feed (MAN)
- **Available only with bore 30**

Item	
TX0008 selling out	Multiprofile set in plastic box

Spare parts:		
	Dimensions	Item
Profile knife for head "1"	R=6	Z055.822.R
Profile knife for head "3"	R=6/8	Z055.824.R
Profile knife for head "4"	R=8/45°	Z055.825.R
Wedge	-	Z056.713.N
Profile knife for head "2"	R=8	Z055.823.R
Wedge	-	Z056.714.N
Profile knife for head "5"	R=12	Z055.826.R
Wedge	-	Z056.715.N
Wedge screw	M8x20	Z051.805.R

HW MITRE JOINT CUTTERHEAD 45°

ART. TSL

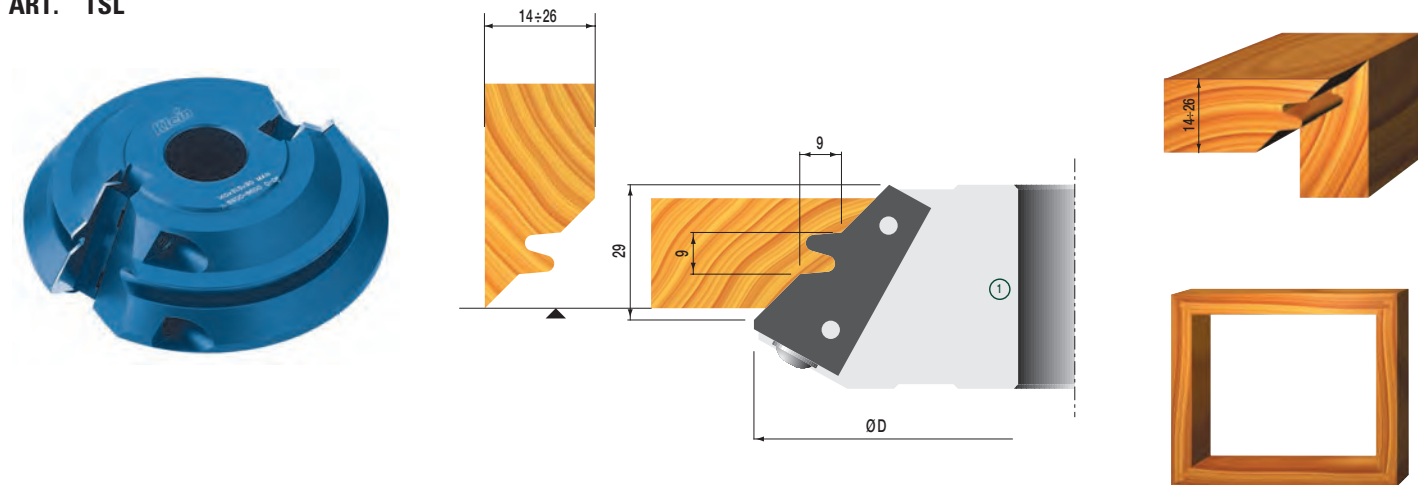

- Produced in light alloy with HW knives
- Manual feed (MAN)

Item	D	d	B	Z
TSL140.32030	140	30	32	2
TSL140.32035	140	35	32	2
TSL140.32040	140	40	32	2

Spare parts:

	Dimensions	Item
Knife	50x22,5x2	Z055.830.R
Wedge	-	Z056.719.N
Wedge stop	-	Z056.800.R
Wedge screw	M8X20	Z051.805.R

HW PROFILE CUTTER

ART. TS

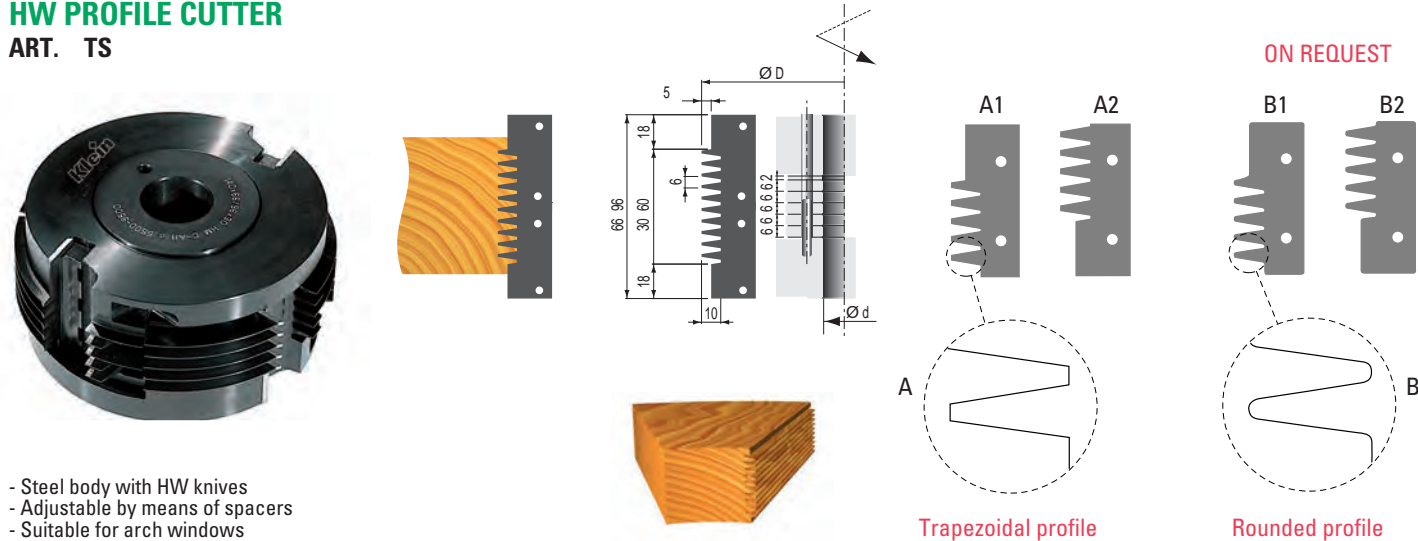

- Steel body with HW knives
- Adjustable by means of spacers
- Suitable for arch windows
- Manual feed (MAN)

Item	D	d	B	Z	Profile
TS140.96030	140	30	66÷96	2+2	A
TS140.96035	140	35	66÷96	2+2	A
TS140.96040	140	40	66÷96	2+2	A

Spare parts:

	Dimensions	Item
Knife "A1"	50x22,5x2	Z055.861.N
Knife "A2"	50x22,5x2	Z055.862.N
Knife "B1"	50x22,5x2	Z055.863.N
Knife "B2"	50x22,5x2	Z055.864.N
Wedge	L= 46	Z056.726.N
Screw	M8X20	Z051.805.R

HW PANEL RAISING SET WITH SIX PROFILES

ART. TTL



- Produced in light alloy with HW knives
- Six knives for working 12 different wood profiles (profiles "A" - "B" - "C" - "D" - "E" - "F")
- Manual feed (MAN)
- Available only with bore 30

Item	D	d	B	Profile	Z
TTL180.22130	180	30	22	D	2
TTL180.22230	180	30	22	E	2
TTL180.22330	180	30	22	F	2
TTL180.23130	180	30	23	A	2
TTL180.23230	180	30	23	B	2
TTL180.23330	180	30	23	C	2

Spare parts:

	Dimensions	Item
Profile knife	Profile "A"	Z055.831.R
Profile knife	Profile "B"	Z055.832.R
Profile knife	Profile "C"	Z055.833.R
Profile knife	Profile "D"	Z055.834.R
Profile knife	Profile "E"	Z055.835.R
Profile knife	Profile "F"	Z055.836.R
Screw	M5x10	Z051.702.R

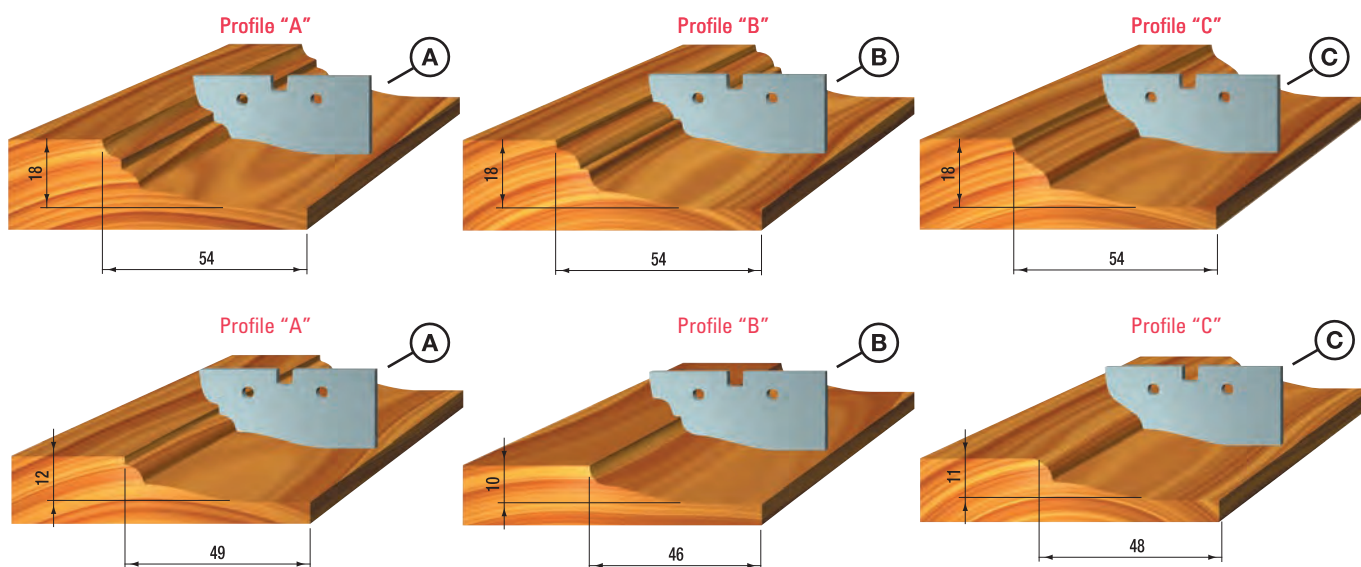

HW PANEL RAISING SET WITH SIX PROFILES

ART. TTL

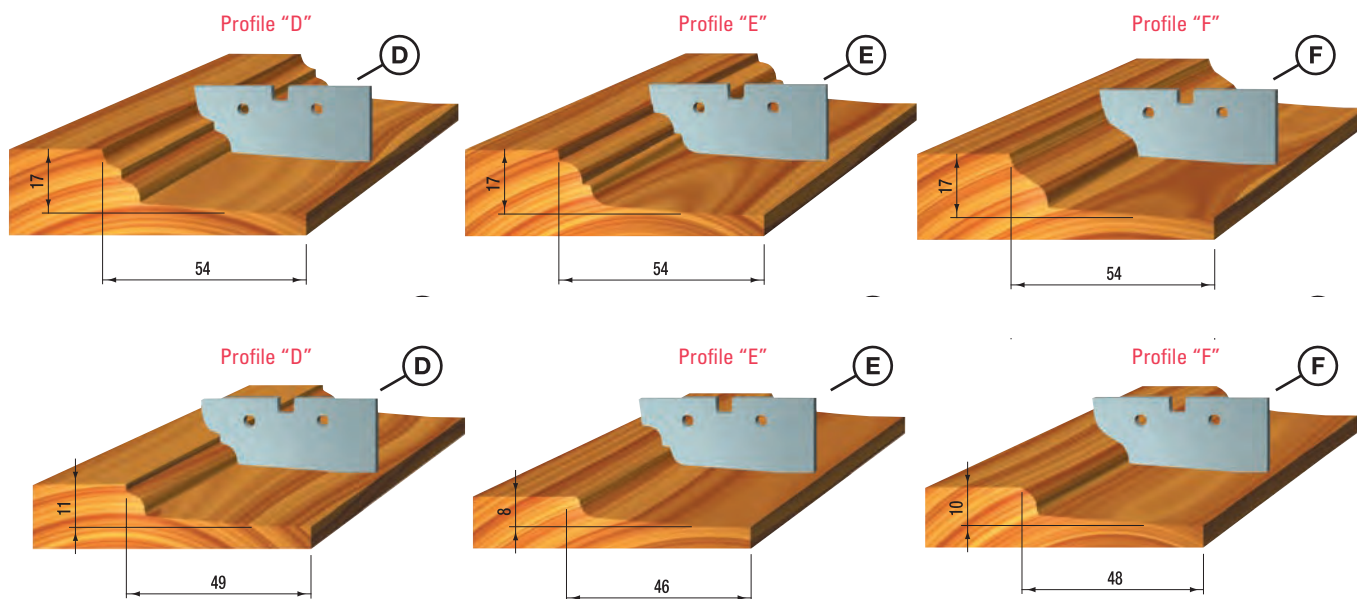

HW PANEL RAISING SET

ART. TX



Art. **TX0010** complete with: **TTL180.22130** +
2 pz. Z055.835.R +
2 pz. Z055.836.R

Art. **TX0011** complete with: **TTL180.23130** +
2 pz. Z055.832.R +
2 pz. Z055.833.R

Available only with bore 30

Item	Description
TX0010	Set in plastic box with cutterhead + 2 profile knives each - Profile D + E + F
TX0011	Set in plastic box with cutterhead + 2 profile knives each - Profile A + B + C

HW PANEL RAISING SET

ART. TWL

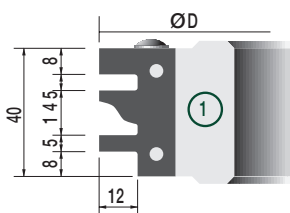
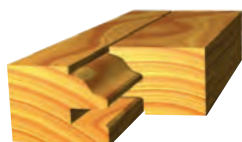

Profile "A"

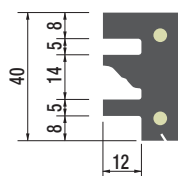

Profile "B"

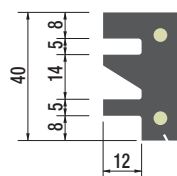

Profile "C"

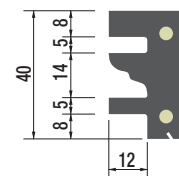

Profile "D"

- Cutterhead for profile and counter profile cutting
- Produced in light alloy with HW knives and shear angle
- The tool body fits 4 different profile knives
- Manual feed (MAN)
- Available also with bore 35/40

Item	D	d	B	Profile	Z
TWL120.40130	120	30	40	A	2
TWL120.40230	120	30	40	B	2
TWL120.40330	120	30	40	C	2
TWL120.40430	120	30	40	D	2

TWL120 diameter 120 mm. bore 35 mm. (code number ends with 35 instead of 30)

TWL120 diameter 120 mm. bore 40 mm. (code number ends with 40 instead of 30)

Spare parts:

	Dimensions	Item
Profile knife	profile "A"	Z055.843.R
Profile knife	profile "B"	Z055.844.R
Profile knife	profile "C"	Z055.845.R
Profile knife	profile "D"	Z055.846.R
Wedge	-	Z056.723.N
Wedge screw	M6X25	Z051.808.R

HW PANEL RAISING SET

ART. TVL

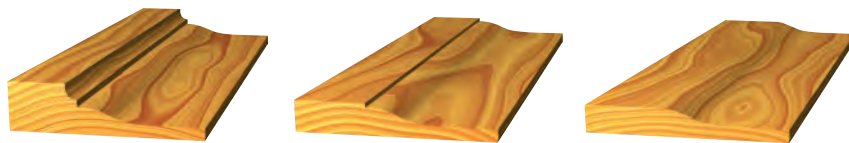
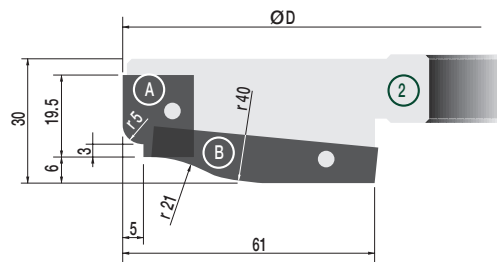

- Produced in light alloy with HW knives
- Manual feed (MAN)

Item	D	d	B	Z
TVL185.30030	185	30	30	2+2
TVL185.30035	185	35	30	2+2

Spare parts:

	Dimensions	Item
Profile knife	profile "A"	Z055.841.R
Wedge	-	Z056.721.N
Wedge screw	M6X25	Z051.808.R
Profile knife	profile "B"	Z055.842.R
Wedge	-	Z056.722.N
Wedge screw	M6X25	Z051.808.R

COUNTERPROFILE-RAISING PANEL SET

ART. TX

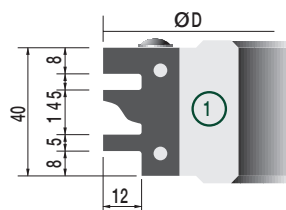
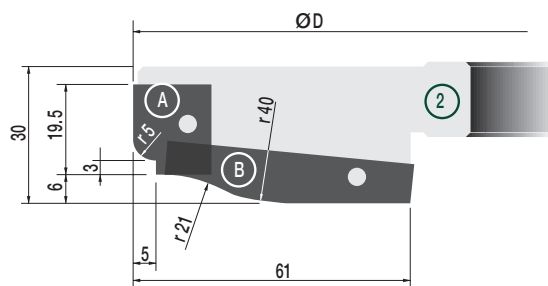

Complete with: **TVL185.30030**
TWL120.40130

Item	
TX0012	Counterprofile-raising panel set in plastic box (on request bore 35/40/50)

HW TOOLING SET FOR PROFILES AND COUNTERPROFILES

ART. TYL

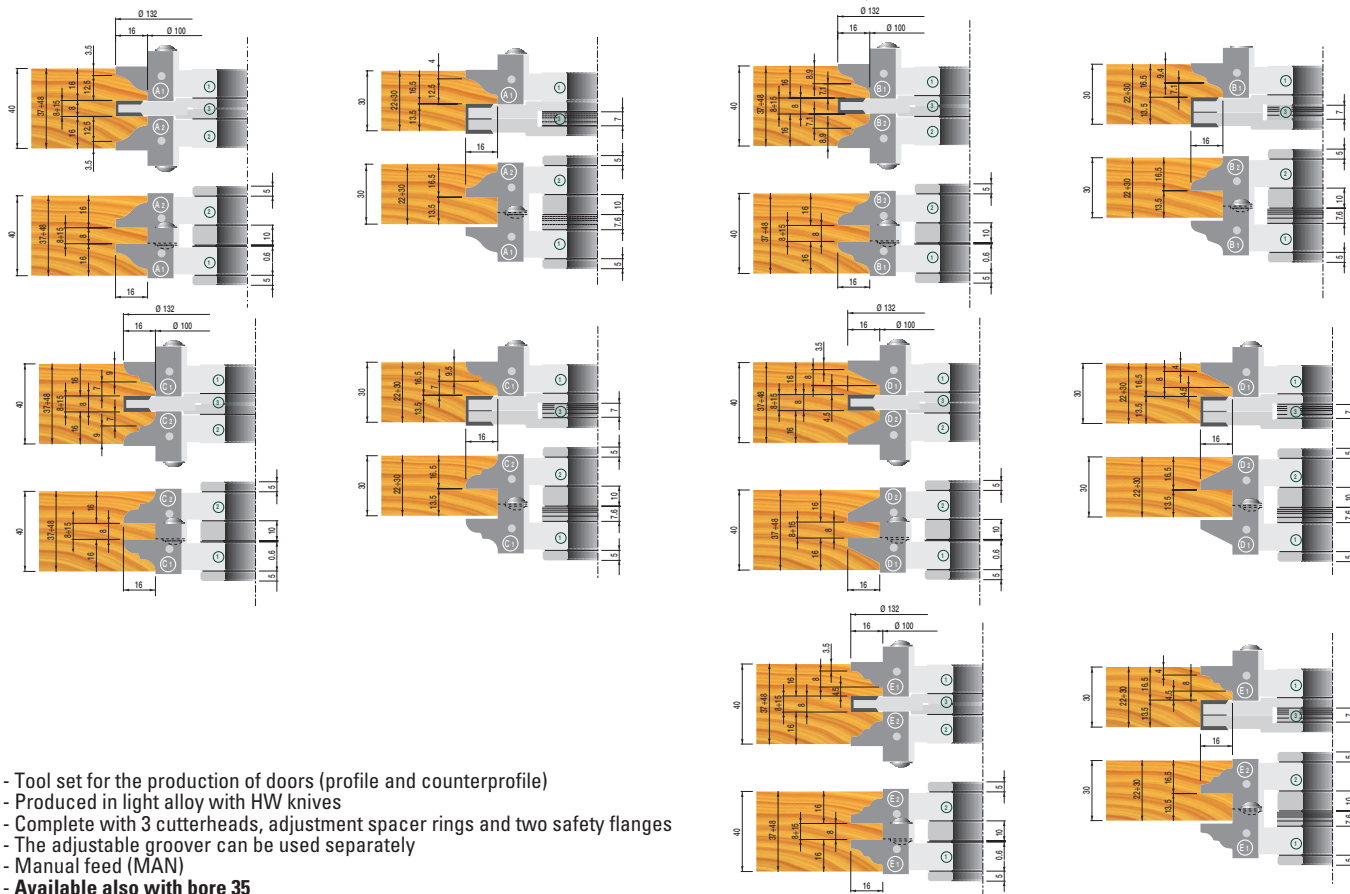
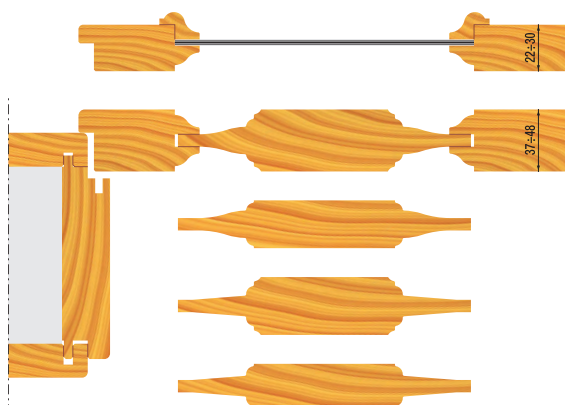

- Tool set for the production of doors (profile and counterprofile)
- Produced in light alloy with HW knives
- Complete with 3 cutterheads, adjustment spacer rings and two safety flanges
- The adjustable groover can be used separately
- Manual feed (MAN)
- Available also with bore 35

Item	D	d	B	Profile	V	Z
TYL132.25130	132	30	50	A1+A2	2	4
TYL132.25230	132	30	50	B1+B2	2	4
TYL132.25330	132	30	50	C1+C2	2	4
TYL132.25430	132	30	50	D1+D2	2	4
TYL132.25530	132	30	50	E1+E2	2	4

TYL132 diameter 132 mm. bore 35 mm. (code number ends with 35 instead of 30)

Spare parts:

	Dimensions	Item
Profile knife	Prof. "A1"	Z055.851.R
Profile knife	Prof. "A2"	Z055.852.R
Profile knife	Prof. "B1"	Z055.853.R
Profile knife	Prof. "B2"	Z055.854.R
Profile knife	Prof. "C1"	Z055.855.R
Profile knife	Prof. "C2"	Z055.856.R
Profile knife	Prof. "D1"	Z055.857.R
Profile knife	Prof. "D2"	Z055.858.R
Profile knife	Prof. "E1"	Z055.859.R
Profile knife	Prof. "E2"	Z055.860.R
Wedge for A1-B1-C1-D1-E1	-	Z056.724.N
Wedge for A2-B2-C2-D2-E2	-	Z056.725.N
Wedge screw	M6X20	Z051.807.R

TONGUE AND GROOVE TOOLING SET

ART. TZL

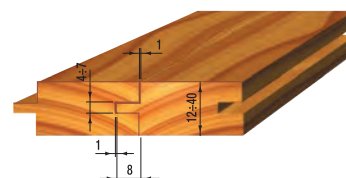
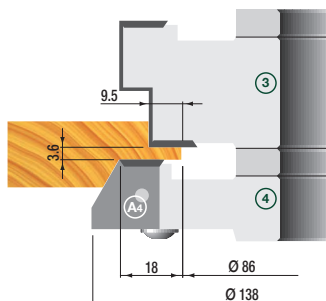
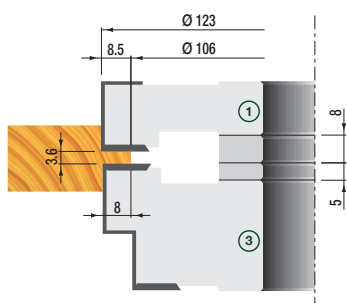
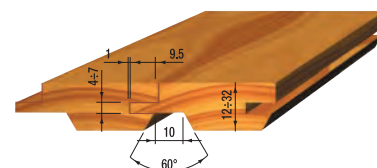
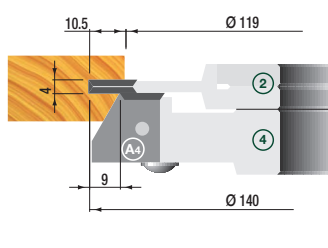
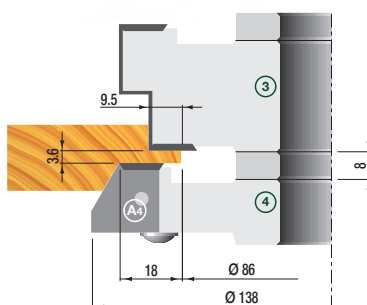
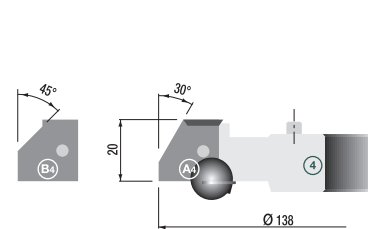
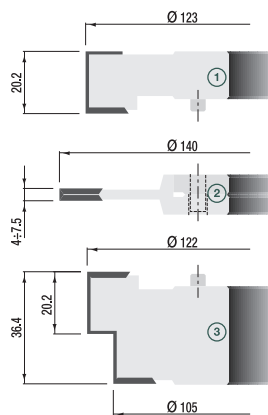
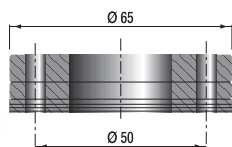

- Tool set for production of wall panels and various types of flooring
- Produced in light alloy with HW knives
- Complete with 4 cutterheads and spacers rings, packed in plastic case
- Manual feed (MAN)

Item	D	d	Bmax	Z	V
TZL138.40030	138	30	40	2	4
TZL138.40035	138	35	40	2	4

Spare parts:

	Dimensions	Item
Knife "1"	20x12x1,5	Z555.003.N
Knife "3"	20x12x1,5	Z555.003.N
Wedge	-	Z056.708.N
Wedge screw	M8x20	Z051.805.R
Spur "1"	14x4x2	Z555.007.N
Spur "3"	14x4x2	Z555.007.N
Spur screw	M5x7	Z051.701.R
Knife "4"	prof. "A4"	Z055.847.R
Knife "4"	prof. "B4"	Z055.848.R
Wedge	-	Z056.708.N
Wedge screw	M8x20	Z051.805.R
Spur "4"	14x4x2	Z555.007.N
Spur screw	M5x7	Z051.701.R

PLANERHEAD

ART. TZA

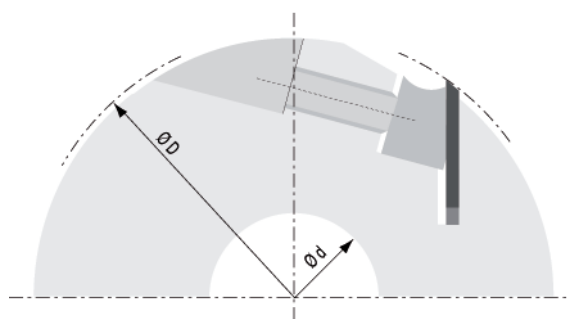

- Produced in light alloy with HS knives (18%W) - 30x3
- Planer knives positioning by means of aligners Art. Y200.125.N (page 11.11)
- Can be equipped with HW knives on request

Item	D	d	B	Z
TZA125.12040	125	40	120	4
TZA125.13040	125	40	130	4
TZA125.15040	125	40	150	4
TZA125.18040	125	40	180	4
TZA125.23040	125	40	230	4

Spare parts:

Item	
Z056.760.N	Wedge L= 120
Z056.761.N	Wedge L= 130
Z056.762.N	Wedge L= 150
Z056.763.N	Wedge L= 180
Z056.764.N	Wedge L= 230
Z051.809.R	Wedge screw M8x18
Z060.100.N	Pressure spring

GUIDE BALL BEARINGS FOR SAWING OUT

ART. Z050

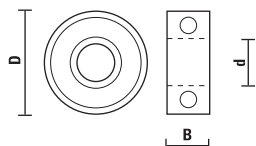

To be used with guide rings Art. Z058

Item	D	d	B
Z050.500.N	62	30	16

GUIDE RINGS FOR BALL BEARING

ART. Z058

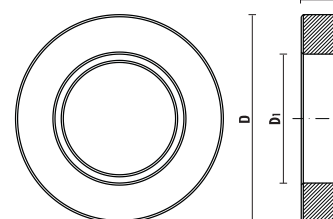

- Guide rings in **light alloy**
- Safety ring in **steel**

Item	D	D1	L	
Z058.501.N	70	62	21,5	
Z058.502.N	75	62	21,5	
Z058.503.N	80	62	21,5	
Z058.504.N	85	62	21,5	
Z058.505.N	90	62	21,5	
Z058.506.N	95	62	21,5	
Z058.507.N	100	62	21,5	
Z058.508.N	105	62	21,5	
Z058.509.N	110	62	21,5	
Z058.510.N	115	62	21,5	
Z058.511.N	120	62	21,5	
Z058.512.N	125	62	21,5	
Z058.900.N	Safety ring	68	30	21,5

REDUCTION RINGS FOR CUTTERHEADS

ART. ZA010

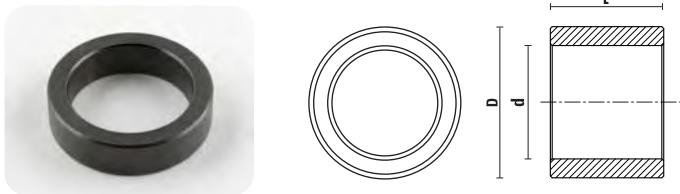

Tolerance:
 D= 0/- 0,02
 d= + 0,02/0
 L= ± 0,02

Item	D	d	L
ZA010.322020	32	20	20
ZA010.353005	35	30	5
ZA010.353010	35	30	10
ZA010.353015	35	30	15
ZA010.353020	35	30	20
ZA010.353025	35	30	25
ZA010.353030	35	30	30
ZA010.353035	35	30	35
ZA010.353040	35	30	40
ZA010.403005	40	30	5
ZA010.403010	40	30	10
ZA010.403015	40	30	15
ZA010.403020	40	30	20
ZA010.403025	40	30	25
ZA010.403030	40	30	30
ZA010.403035	40	30	35
ZA010.403040	40	30	40
ZA010.403505	40	35	5
ZA010.403510	40	35	10
ZA010.403515	40	35	15
ZA010.403520	40	35	20
ZA010.403525	40	35	25
ZA010.403530	40	35	30
ZA010.403535	40	35	35
ZA010.403540	40	35	40

REDUCING BUSHES

ART. ZA011

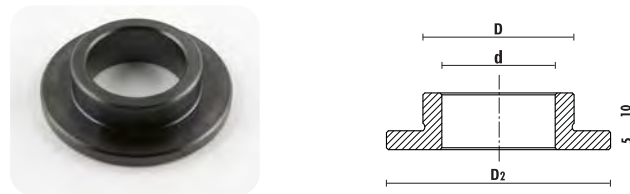

Tolerance:
 D= 0/- 0,02
 d= 0/- 0,02

Item	D	d	D2
ZA011.03530	35	30	55
ZA011.04030	40	30	60
ZA011.04035	40	35	55
ZA011.05030	50	30	70
ZA011.05035	50	35	70
ZA011.05040	50	40	70

VISIT OUR WEBSITE
www.sistemiklein.com



BALL BEARING WITH BUTTING RING SET

ART. TX

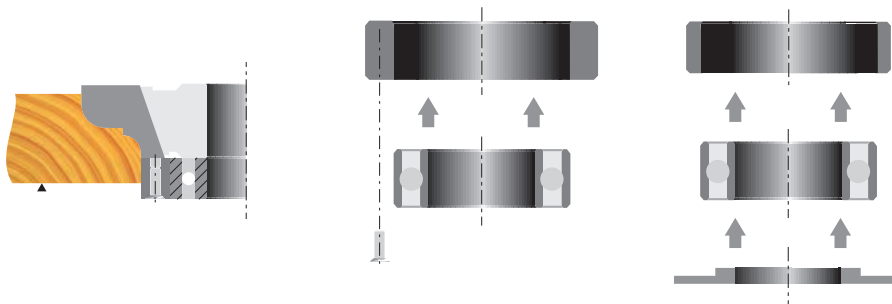

Item

TX0050

Complete with 6 pcs.:

Z050.500.N - 1 ball bearing

Z058.501.N - 1 guide ring D=70

Z058.505.N - 1 guide ring D=90

Z058.507.N - 1 guide ring D=100

Z058.511.N - 1 guide ring D=125

Z058.900.N - 1 safety ring D=68

LUBRICANTS, DIAMOND GRINDING WHEELS AND DIAMOND STONES

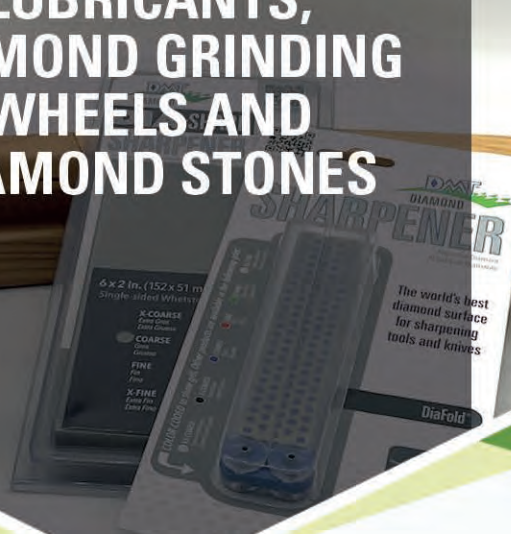

KLEIN TOPUP
Pag. 14.03



KLEIN DRYUP
Pag. 14.03



KLEIN PROTECT
Pag. 14.03



KLEIN CLEANUP
Pag. 14.03



KLEIN WASHER
Pag. 14.03



KLEIN CLEANER
Pag. 14.03



4" DIAMOND WHETSTONE
Pag. 14.04



4" DIAMOND WHETSTONE
Pag. 14.04



MACHINIST POCKET WHETSTONE
Pag. 14.04



MACHINIST POCKET WHETSTONE
Pag. 14.04



MACHINIST POCKET WHETSTONE
Pag. 14.05



DIAFOLD DIAMOND WHETSTONE
Pag. 14.05



DIAFOLD DIAMOND FLAT FILE
Pag. 14.05



DIAFOLD SERRATED KNIFE SHARPENER
Pag. 14.05

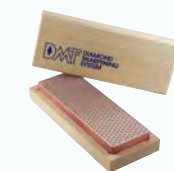

6"/8"/12" DIAMOND WHETSTONE
Pag. 14.06



DEMO-STAND
Pag. 14.06

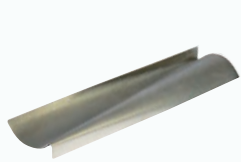

DIAMOND WAVE SHARPENERS FOR RADIUS CUTTERS
Pag. 14.07



8" DIAMOND WHETSTONE WITH BASE
Pag. 14.07



DIAMOND WHETSTONE
Pag. 14.07



DIAMOND WHETSTONE
Pag. 14.07



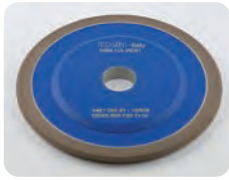

GRINDING WHEEL FOR ROUNDED SPURS
DOWEL DRILLS
Page 14.08



GRINDING WHEEL FOR DOWEL DRILLS
Page 14.08



HIGH PERFORMANCE CUTTING DISC
Pag. 14.09



GRINDING WHEEL FOR HOLLOW PARTS
AND HOLES
Pag. 14.09

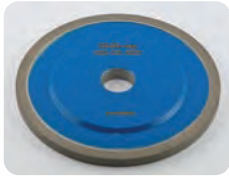

GENERAL PURPOSE STRAIGHT WHEEL
Pag. 14.09



GENERAL PURPOSE STRAIGHT WHEEL
Pag. 14.09



GRINDING WHEEL
FOR HW TIPPED CUTTERS
Pag. 14.09



GRINDING WHEEL
FOR PLANER KNIVES
Pag. 14.09



GRINDING WHEEL
FOR ROUTER CUTTERS
Pag. 14.10

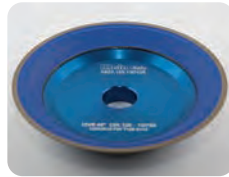

GRINDING WHEEL
FOR ROUTER CUTTERS
Pag. 14.10



GRINDING WHEEL FOR HW TIPPED
SAWBLADES
Pag. 14.10



GRINDING WHEEL FOR HW TIPPED
SAWBLADES
Pag. 14.10

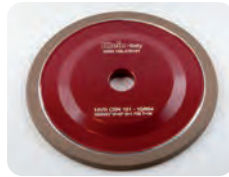

GRINDING WHEEL FOR BAND SAWBLADES
Pag. 14.10

The best for a proper maintenance

KleinTOPUP

Table and tool surface sealant



- Eliminates "hang-ups" on sliding surfaces
- Protects all tools and equipment from rust.
- Up to 30% slicker than paste wax.
- Prevents rust 5 times longer than paste wax or silicone.
- Easier and quicker to apply
- Contains no silicone or petroleum oil.
- Will not stain wood or interfere with glues or finishes.
- Perfect for table saws, drill presses, lathes, planers, band saws, mitres, panel saws and all hand tools.
- Environment-friendly, doesn't contain CFCs or any other ODS.

Item	Description
KLEINTOPUP.400	Spray Can 400 ml.

KleinDRYUP

Blade and bit cutting lubricant



- Prevents resin build-up.
- Reduces blade cleanings.
- Extends overall life of blades and bits by up to 3 times!
- More than doubles time between sharpenings.
- Contains NO silicone or petroleum oil. Will NOT stain wood or interfere with glues or finishes.
- Reduces cutting friction and heat by 30%.
- Prolongs equipments life by reducing saw or drill motor drag by up to 25%.
- Increases productivity by less downtime for saw blade changeovers.
- Works equally well on steel or carbide, stellite and diamond-tipped cutting blades.
- Environment-friendly, doesn't contain CFCs or any other ODS.

Item	Description
KLEINDRYUP.400	Spray Can 400 ml.

KleinPROTECT

Protective lubricant for cutting tools



- Removes easily and rapidly any residues of grease, coolants and synthetic compounds.
- If regularly used, protects and prevents from rust and corrosion
- Displaces moisture and condensation in case of difficult weather conditions.
- Extremely efficient on every metal surface
- Can be applied also on alloys containing copper, magnesium, nickel, steel, stainless steel, titanium and zinc, or polymers and elastomers.
- Can be used on all types of delicate machinery and mechanisms for weapons (according to U.S. Army specifications).

Item	Description
KLEINPROTECT.400	Spray Can 400 ml.
KLEINPROTECT.5000	Liquid – Tank 5 L

KleinCLEANUP

Detergent for cutting tools cleaning



- Water-based detergent for clearing tools
- Recommended for removing resin or sludge from tools
- No corrosive or dulling effect
- Not foaming
- Not flammable, doesn't contain solvents
- Non-toxic, not health-harming
- Biodegradable
- Suitable also for washers
- Can be used on any mechanical parts or tools also mounted on groups for windows

Item	Description
KLEINCLEANUP.1000	Liquid – Bottle 1 L
KLEINCLEANUP.10000	Liquid – Tank 10 L

KleinWASHER

Automatic Tool Washer

- Suitable for washing any metal parts and tools from the industry to the smaller workshop
- For tools of various dimensions, also for tool groups for windows thanks to its rotating tank with an height of 350 mm
- Heated biological operating mode
- To be used only with water-based detergent (see our item **KleinCLEANUP**)

Includes:

- Stainless steel housing
- Rotating tank D=600 mm
- Tank's capacity: 75 L
- Maximum payload: 100 kg
- Maximum height of the tools: 350mm
- Stainless steel upper, under and lateral washing arms
- Timer
- Thermal resistance
- Single-phase 1 hp pump
- Dimensions: 940x790 h930 mm
- Dimensions packing: 1210x1050 h1200 mm
- Weight: 65 kg



Item
KLEINWASHER

See section 16 page 16.16

KleinCLEANER

Manual Tool Washer

- Can wash any type of tools or metal parts
- Easy to be used with water and spray gun
- Heated biological operating mode

Includes:

- Spray gun
- Tool holding grid
- Stainless steel tank with thermal resistance
- Air-operated double diaphragm pump 5 L/min
- Tank dimensions: 600x500 h 250 mm
- Tank capacity: 70L
- Dimensions: 700x560 h1000 mm
- Dimensions packing: 970x670 h1020
- Weight: 30 Kg



Item
KLEINCLEANER

See section 16 page 16.16

DIAMOND WHETSTONE



Grind and spare!
A complete range of diamond stones for any kind of application
JUST DIAMOND CAN GIVE YOU THE EDGE OF PERFECTION!

- FAST** - Hardest material; most efficient sharpening abrasive
- EASY** - Light pressure produces a sharp edge with just a few strokes
- CLEAN** - Use water for lubricant - No oil, no mess!
- VERSATILE** - Hones all hard materials: carbide, steel, etc.
- DURABLE** - Stays flat



- **X-Coarse** Most rapid stock removed for dressing nicked or damaged knives and chisels or sharpening heavy cutting tools such as axes and lawnmower blades.
- **Coarse** Rapidly restores a sharp edge on dull knives and tools. Perfect for honing garden tools, sport knives, scissors and general tools.
- **Fine** Ideal for honing a razor sharp edge on quality cutlery and woodworking tools that are regularly maintained.
- **Extra-Fine** the ultimate edge refinement for the finest quality knives and woodworking tools. Recommended after edge has been sharpened on the grit.

4" DIAMOND WHETSTONE

ART. W4



In leather sheath



Item	Grit sizing
W4E	Extra-fine
W4F	Fine
W4C	Coarse
W4X	X-Coarse



4" DIAMOND WHETSTONE

ART. A4

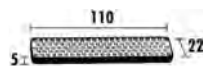

In plastic package



Item	Grit sizing
A4E	Extra-fine
A4F	Fine
A4C	Coarse
A4X	X-Coarse

MACHINIST POCKET WHETSTONE

ART. WM



- In leather sheath
- Ideal for resharpening small size tools



Item	Grit sizing
WMF	Fine
WMC	Coarse

MACHINIST POCKET WHETSTONE

ART. WS7

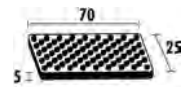
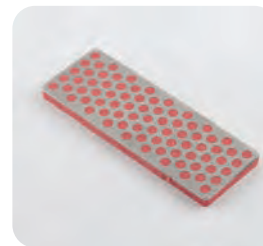

In plastic package



Item	Grit sizing
WS7E	Extra-fine
WS7F	Fine
WS7C	Coarse
WS7X	X-Coarse



MACHINIST POCKET WHETSTONE

ART. F70

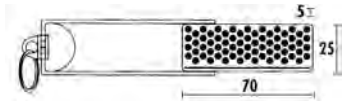

In plastic package



Item	Grit sizing
F70F	Fine
F70C	Coarse

DIAFOLD DIAMOND FLAT FILE

ART. FF

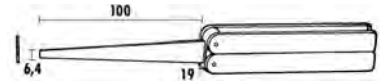

Pocket diafold diamond flat file



Item	Grit sizing
FFF	Fine
FFC	Coarse

DIAFOLD DIAMOND WHETSTONE

ART. FW

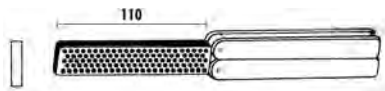
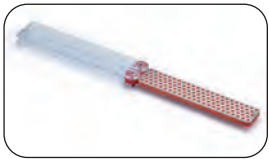

Diafold sharpeners with folding plastic handles



Item	Grit sizing
FWE	Extra-fine
FWF	Fine
FWC	Coarse
FWX	X-Coarse

FWEF	Ex.-fine/fine
FWFC	Fine/Coarse
FWCX	Coarse/X-Coarse



DIAFOLD SERRATED KNIFE SHARPENER

ART. FSK

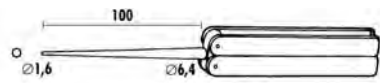
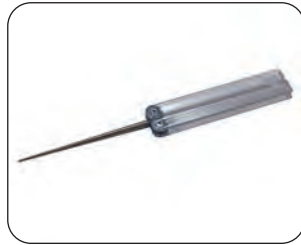

Pocket diafold conical diamond file



Item	Grit sizing
FSKF	Fine
FSKC	Coarse



6"/8"/12" DIAMOND WHETSTONE

ART. W6 - W8 - WT

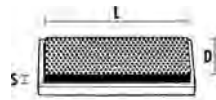
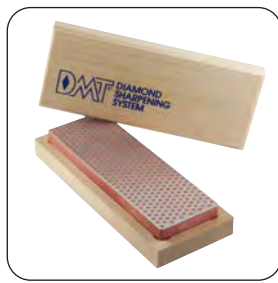

Bench model in hardwood case

Item	Grit sizing	L	D	S
W6E	Extra-fine	152	51	19
W6F	Fine	152	51	19
W6C	Coarse	152	51	19
W6X	X-Coarse	152	51	19
W8E	Extra-fine	205	67	32
W8F	Fine	205	67	32
W8C	Coarse	205	67	32
W8X	X-Coarse	205	67	32
WTF	Fine	305	67	32

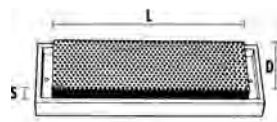
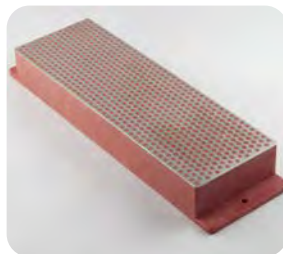

Bench model in plastic case

Item	Grit sizing	L	D	S
W6EP	Extra-fine	152	51	19
W6FP	Fine	152	51	19
W6CP	Coarse	152	51	19
W6XP	X-Coarse	152	51	19
W8ENB	Extra-fine	205	67	32
W8FNB	Fine	205	67	32
W8CNB	Coarse	205	67	32
W8XNB	X-Coarse	205	67	32



DEMO-STAND

ART. PDW6



- Demo stand including a diamond whetstone
- Supplied free of charge when ordering **two pieces** each of the following items

ART. F70F
ART. F70C



ART. W6F
ART. W6C



ART. W4F
ART. W4C



ART. FWF
ART. FWC



Item	Grit sizing	Dimensions
PDW6F	Fine	152x51x19
PDW6C	Coarse	152x51x19

NEW DEALER STARTER KITS

Pcs	Item
1	PDW6C
2	W6FP
2	W6CP
2	F70F
2	F70C
2	FWE
2	FWF
2	FWC
2	FSKC

DIAMOND WAVE SHARPENERS FOR RADIUS CUTTERS

ART. WAVF

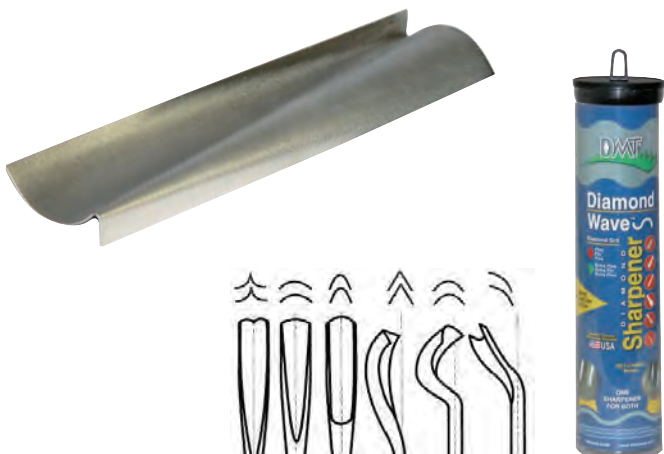

- **DIAMOND WAVE**
- Ideal for resharpening curved tools, like gouges, carving and wood turning tools
- Convex and concave diamond surface in one sharpening tool
- Resharpen tools with radius from min. 1,6 to max. 25 mm.
- Including anti-slippery pad for easier use
- No oil is needed – sharpen dry or with water



Item	Grit sizing	Dimensions
WAVF	Fine	30x250x25

8" DIAMOND WHETSTONE WITH BASE

ART. WM8FC-WB



- **DUOSHARP**
- Double-sided stone:
 - **Coarse grit** to quickly restore a neglected edge
 - **Fine grit** for a razor sharp edge
- Ideal for all craftsmen who need to resharpen straight cutting edges
- Can resharpen a wide range of materials: carbide, steel, ceramic, glas, stone
- Supplied with plastic base



Item	Grit sizing	Dimensions
WM8FC-WB	Coarse/Fine	203x66 mm

Spare parts

WM8FC	Coarse/Fine	203x66 mm
-------	-------------	-----------



NEW DIAMOND SHARPENERS "ECONOMY LINE"



Sharpens, hones & laps: knives, router bits, plane blades, ski edges, fish hooks, garden tools, chisels, scissors, sawblades, lapidary, ceramics, broadheads, climbing equipment, masonry drills, axes, engraving tools, farm tools, mold & dies, planer/jointer knives, speed skates, carbide, glass.



- COARSE (C) - 45 micron**
General use-rapidly restores a dull edge on a tool or knife
- FINE (F) - 25 micron**
Restores a razor edge on well maintained tools and knives
- Ex-FINE (E) - 9 micron**
The ultimate edge refinement after stock removal on coarser diamond

DIAMOND WHETSTONE

ART. D4



In plastic package



Item	Grit sizing	Dimensions
D4E	Extra-fine	110x22x5
D4F	Fine	110x22x5
D4C	Coarse	110x22x5

DIAMOND WHETSTONE

ART. D6



In plastic package



Item	Grit sizing	Dimensions
D6E	Extra-fine	150x50x6
D6F	Fine	150x50x6
D6C	Coarse	150x50x6

GRINDING WHEELS



As a result of long experience in the production of special, high precision tools, **SISTEMI** has developed the Super Diamond **Klein**, which allows performing quicker and more economically efficient abrasive machining operations. Obtained by a process of synthesis to very high pressure and temperature, the diamond used in the grinding wheels **Klein** is artificial and has been tested to provide the best possible result on the machines for regrinding tools for woodworking, while for ferrous materials, such as tools in HSS, CBN (Cubic boron nitride) is used.

The choice of grain size plays also an important role and **SISTEMI** has decided to limit the amount of grains available in its program by choosing those with the best performance of most use.

The grains of diamond or CBN are agglomerated with different binders, classified according to the following characteristics:

- Capacity of particle retention
- Capacity of discharging worn grains
- Dressing capacity
- Thermal resistance
- Thermal conductivity
- Type of material to be processed

The attention to component selection and manufacturing process ensures that **Klein** grinding wheels are products of high precision. Mounting flanges, back-plates or adapters must be absolutely used and kept in good condition. All possible defects in the wheel-arbor coupling must be corrected before starting the wheel.

Furthermore it is important to remember that the use of coolant increases the cutting performance of the grinding wheels, reducing friction, heat generation and jamming of the abrasive surface.

Our Super Diamond **Klein** can be supplied in different shapes or dimensions on request, as well as in other grain sizes or bond types.

GRINDING WHEEL FOR ROUNDED SPURS DOWEL DRILLS

ART. X900

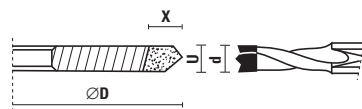

- Type 1A1 SPECIAL
- Abrasive material
- Grain size D91
- Suitable for Art. L114 - L115 - L116 - L117

Item	Tool diam.	ØD	Bore	U	X
X900.125.05D91	3÷7	125	20	5,5	8
X900.125.07D91	8÷10	125	20	7	8

GRINDING WHEEL FOR DOWEL DRILLS

ART. X901

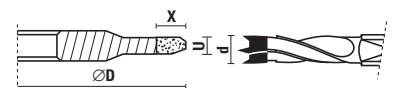
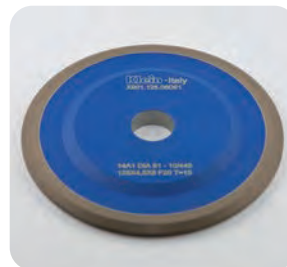

- Type 14A1 SPECIAL
- Abrasive material
- Grain size D91
- Suitable for Art. L101 - L102 - L103 - L104 - L105 - L106 - L107 - L108 - L109 - L110

Item	Tool diam.	ØD	Bore	U	X
X901.125.04D91	4	125	20	4	8
X901.125.05D91	5	125	20	4,5	8
X901.125.06D91	6	125	20	4,5	8
X901.125.08D91	8	125	20	5	8
X901.125.10D91	10	125	20	6	8

HIGH PERFORMANCE CUTTING DISC

ART. X902

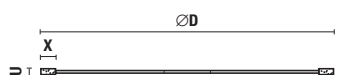

- Type 1A1R
- Abrasive material
- Grain size D181

Item	ØD	Bore	U	X
X902.125.12D181	125	20	1,2	6
X902.150.12D181	150	20	1,2	6

GRINDING WHEEL FOR HOLLOW PARTS AND HOLES

ART. X903

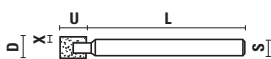

- Type 1A1W
- Abrasive material
- Grain size D126

Item	D	U	X	S	L
X903.006.06D126	6	6	1,5	6	60
X903.008.06D126	8	6	2	6	60
X903.010.06D126	10	6	2	6	60
X903.012.06D126	12	6	2	6	60

GENERAL PURPOSE STRAIGHT WHEEL

ART. X904

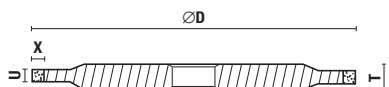
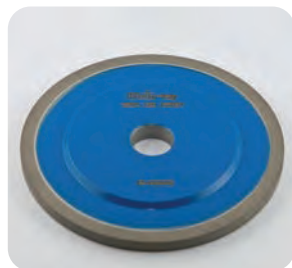

- Type 14A1
- Abrasive material
- Grain size D91

Item	ØD	Bore	U	X	T
X904.075.46D91	75	20	4	6	8
X904.075.66D91	75	20	6	6	10
X904.075.86D91	75	20	8	6	12
X904.100.46D91	100	20	4	6	8
X904.100.66D91	100	20	6	6	10
X904.100.86D91	100	20	8	6	12
X904.125.66D91	125	20	6	6	10
X904.125.86D91	125	20	8	6	12

GENERAL PURPOSE STRAIGHT WHEEL

ART. X905

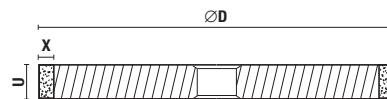

- Type 1A1
- Abrasive material
- Grain size D91

Item	ØD	Bore	U	X
X905.125.10D91	125	20	10	6
X905.125.12D91	125	20	12	6

GRINDING WHEEL FOR HW TIPPED CUTTERS

ART. X920

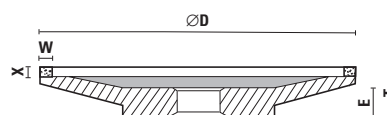

- Type 12A2 20°
- Abrasive material
- Grain size D64

Item	ØD	Bore	W	X	T	E
X920.150.46D64	150	20	6	4	21	9

GRINDING WHEEL FOR PLANER KNIVES

ART. X921

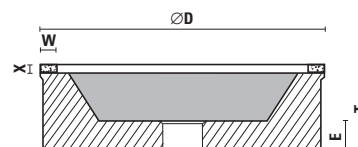

- Type 6A2
- D91 diamond type for HW knives
- Carborundum (CBN) B151 for HS knives

Item	ØD	Bore	W	X	T	E	Grain size	Abrasive
X921.125.45D91	125	16	5	4	40	16	D91	DIA
X921.150.46D91	150	20	6	4	49	15	D91	DIA
X921.175.56D91	175	20	6	5	56	15	D91	DIA
X921.125.45B151	125	16	5	4	40	16	B151	CBN
X921.150.46B151	150	20	6	4	49	15	B151	CBN

GRINDING WHEEL FOR ROUTER CUTTERS

ART. X922

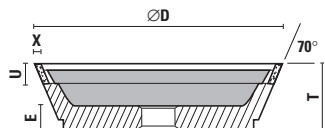

- Type 11V9
- Abrasive material
- Grain size D126
- For tool top and diameter regrinding
- For both HW straight router bits and solid carbide spiral router bits

Item	ØD	Bore	U	X	T	E
X922.075.13D126	75	20	10	3	30	11
X922.100.13D126	100	20	10	3	33	12

GRINDING WHEEL FOR ROUTER CUTTERS

ART. X923

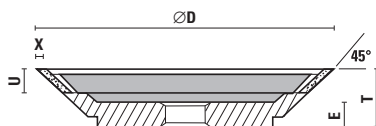

- Type 12V9 45°
- Abrasive material
- Grain size D126
- For tool face grinding on solid carbide spiral router cutters

Item	ØD	Bore	U	X	T	E
X923.075.13D126	75	20	10	3	20	10
X923.100.13D126	100	20	10	3	25	11
X923.125.13D126	125	20	10	3	26	12

GRINDING WHEEL FOR HW TIPPED SAWBLADES

ART. X930

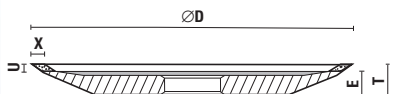

- Type 12V2
- Abrasive material
- Grain size D64
- Tooth face grinding
- Finishing grinding wheel

Item	ØD	Bore	X	U	T	E	Machine type
X930.075.24D64	75	25	4	2	10	8	Grifo AC66
X930.100.33D64	100	25 ch	3	3	11	8	Grifo AC90
X930.125.33D64	125	25 ch	3	3	12	8	Vollmer
X930.126.33D64	125	32	3	3	12	8	Vollmer CHC
X930.150.33D64	150	32	3	3	12	8	Ake
X930.175.33D64	175	50,8+1	3	3	12	12	Finimat
X930.200.33D64	200	32	3	3	12	11	Vollmer CHP

GRINDING WHEEL FOR HW TIPPED SAWBLADES

ART. X940

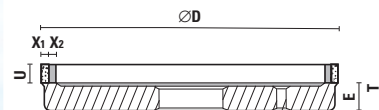
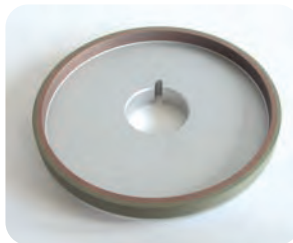

- Type 6AA9
- Abrasive material
- Grain size D126/46
- Tooth top grinding
- Double grain grinding wheel for single pass rough and finishing

Item	ØD	U	X1+X2	T	E	Bore	Machine type
X940.075.62D12646	75	6	2,5+2,5	17	9	25 ch	Grifo AC66
X940.100.82D12646	100	8	2,5+2,5	18	9	25 ch	Grifo AC90
X940.125.82D12646	125	8	2,5+2,5	20	11	32 ch	Voll. CHC - CHP
X940.126.82D12646	125	8	2,5+2,5	20	11	50,8+1	Finimat

GRINDING WHEEL FOR BAND SAWBLADES

ART. X950

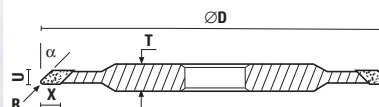

- Type 14VR
- Carborundum (CBN) grinding wheels
- Grain size B181
- For hardened steel and/or stellite

Item	ØD	U	X	T	R	α	Bore
X950.150.47B181	150	4	7	10	1	40°	20

MEASURING INSTRUMENTS



PRE SET PERFORMANCE
Page 15.04 - 15.05



PRE SET LEADER PLUS
Page 15.06 - 15.07



PRE SET UNIKO
Page 15.08 - 15.09



PRE SET PRIME
Page 15.10 - 15.11



PRE SET P368LR
Page 15.12



PRE SET P368XL
Page 15.13



ANGOLFAST
Page 13.14

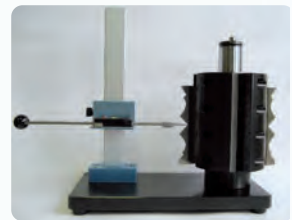

PRE SET P322
Page 13.14



THREE POINT DIGITAL CALIPER FOR CUTTERS Z=3
Page 13.14

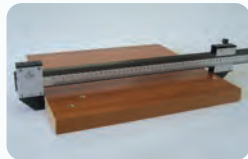

GAUGE FOR LINEAR MEASUREMENTS
Page 15.15

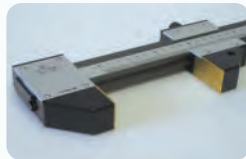

GAUGE FOR LINEAR MEASUREMENTS WITH STEEL PLATES
Page 15.15



GAUGE FOR DISTANCE BETWEEN HOLES
Page 15.16



GAUGE FOR 90° V-FOLD CUTS
Page 15.16

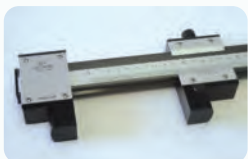

GAUGE FOR INSIDE/OUTSIDE MEASURING
Page 15.17



GAUGE FOR INSIDE/OUTSIDE MEASURING WITH STEEL PLATES
Page 15.17



GAUGE FOR LINEAR MEASUREMENTS AND DISTANCE BETWEEN CENTRES
Page 15.18



GAUGE FOR LINEAR MEASUREMENTS AND DISTANCE BETWEEN CENTRES
Page 15.18



GAUGE FOR LINEAR MEASUREMENTS, DISTANCE FROM THE CENTRES OF THE HOLE TO THE EDGE OF THE PANEL
Page 15.18

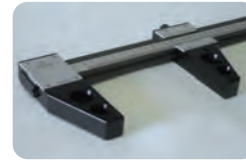

GAUGE FOR LINEAR MEASUREMENTS, WITH LONG JAWS
Page 15.19

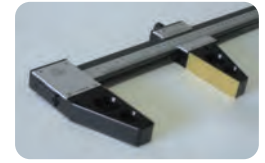

GAUGE FOR LINEAR MEASUREMENTS, WITH LONG JAWS AND STEEL PLATES
Page 15.19



GAUGE FOR 45° CUTS
Page 15.20



GAUGE FOR DIAGONAL AND OUT OF SQUARE MEASUREMENTS
Page 15.20

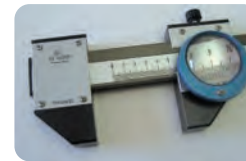

OPTICAL LENS
Page 15.21



CALIBRATION CERTIFICATE
Page 15.21

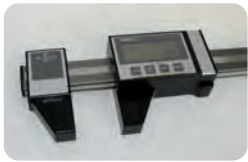

GAUGES FOR LINEAR MEASUREMENTS
Page 15.22



GAUGES FOR LINEAR-INSIDE/OUTSIDE MEASUREMENTS
Page 15.22



GAUGE FOR LINEAR, INSIDE/OUTSIDE, DISTANCE BETWEEN HOLES, OUT OF SQUARE ANGLES MEASUREMENTS
Page 15.23



GAUGE FOR 45° CUTS
Page 15.23



GAUGE FOR LINEAR, INSIDE/OUTSIDE, DISTANCE BETWEEN HOLES, OUT OF SQUARE ANGLES MEASUREMENTS
Page 15.24



GAUGE FOR LINEAR MEASUREMENTS, WITH LONG JAWS AND STEEL PLATES
Page 15.25



GAUGE WITH NONIUS FOR LINEAR-INSIDE/OUTSIDE MEASUREMENTS WITH LONG JAWS AND STEEL PLATES
Page 15.25



GAUGE WITH WIRELESS CONNECTION FOR LINEAR MEASUREMENTS
Page 15.26



GAUGE WITH WIRELESS CONNECTION FOR LINEAR, INSIDE/OUTSIDE, DISTANCE BETWEEN HOLES, OUT OF SQUARE ANGLES MEASUREMENTS
Page 15.26



MAGNETIC STRIP MEASURING SYSTEM
Page 15.27



ELECTRONIC WORK STATION
Page 15.28 - 15.29

OUR RANGE OF PRESETTING

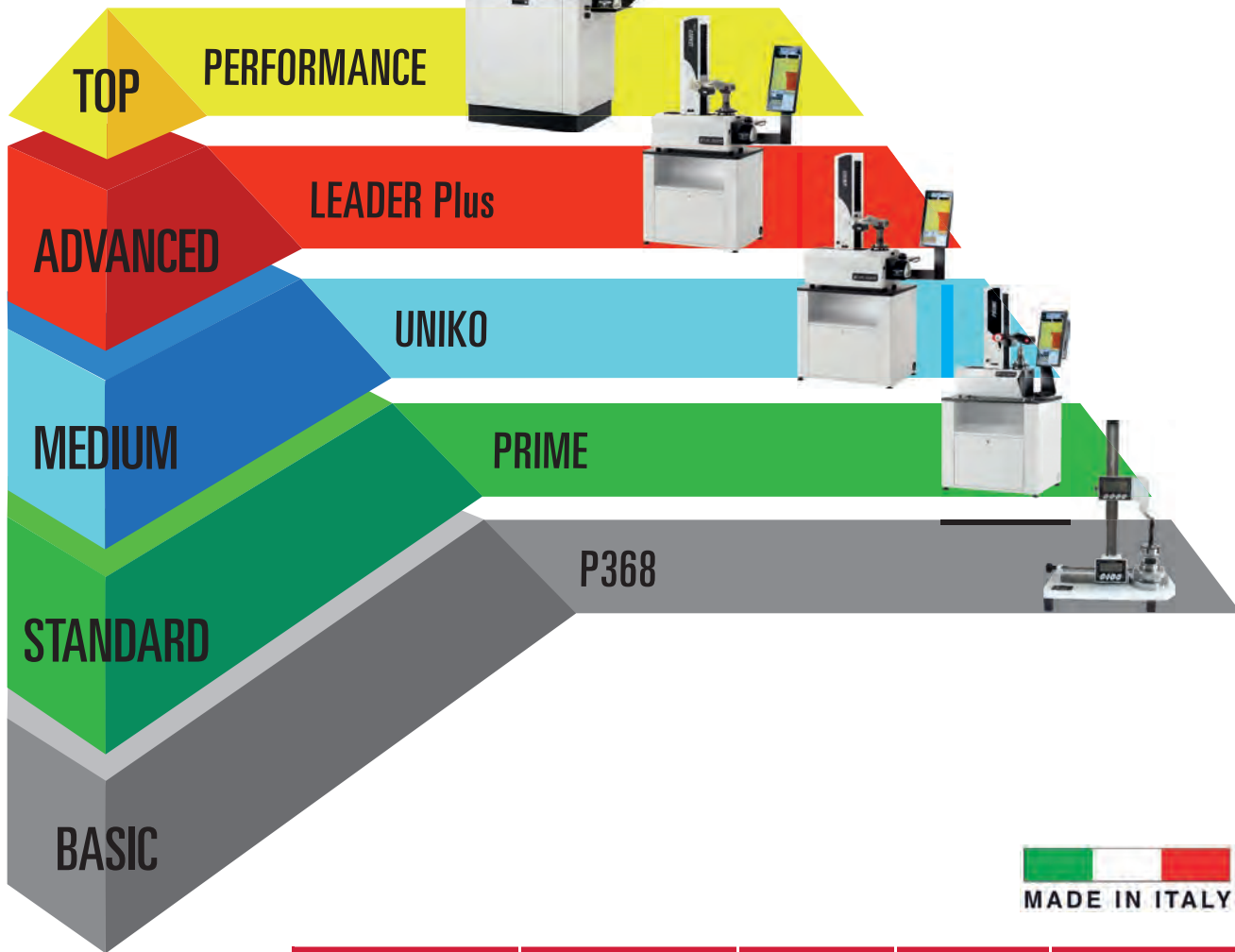

	PERFORMANCE	LEADER PLUS	UNIKO	PRIME	P368
Monitor	24" HD (22" touch screen optional)	22" HD (22" touch screen optional)	19"	19"	2 LCD displays
Tool sleeve rotation brake	Pneumatic	Mechanical	Mechanical	Mechanical	Not available
Axis locking	Pneumatic	Pneumatic	Mechanical	Mechanical	Mechanical
Fine micrometric adjustment	✓	✓	✓	✓	✓
Zero setting	Calibration spheres	Calibration spheres	Calibration spheres	Reference notch	Reference planes
Software	CVS full	CVS full	CVS smart	CVS smart	Not available
DXF software	✓	Optional	Not available	Not available	Not available
Ghost software	✓	✓	Optional	✓	Not available
Led ring illuminator	✓	✓	✓	✓	Not available
Optical zoom magnification	40x	40x	40x	40x	Not available
Field of view	7x7 mm	7x7 mm	5x5 mm	5x5 mm	Not available
Max measurable diameter	Ø 600 mm	Ø 400 mm	Ø 400 mm	Ø 320 mm	Ø 250 (P368LR) Ø 400 (P368XL)
Max measurable height	800 mm	500 mm	500 mm	400 mm	300 mm
USB	7	7	4	3	Not available
Resolution	0,001 mm	0,001 mm	0,001 mm	0,001 mm	0,01 mm

PRE SET PERFORMANCE

The m. conti has been producing presetters for over 30 years. This experience has allowed to understand the importance of ease of use and ergonomics. In m. conti these important factors are held in great importance when designing presetters. Everything is within reach and easy to handle. Designed and developed in the field of tooling manufacture, the **preset PERFORMANCE** are also essential in sharpening centers and production units of furniture or windows, for checking the condition of the tools and their settings before being mounted in the machine. **The preset PERFORMANCE** is supplied with a cone-holder HSK63F.

Item	Measuring range
PRE-SET PERFORMANCE 44	H 400 mm - Ø 400 mm
PRE-SET PERFORMANCE 45	H 500 mm - Ø 400 mm
PRE-SET PERFORMANCE 46	H 600 mm - Ø 400 mm
PRE-SET PERFORMANCE 65	H 500 mm - Ø 600 mm
PRE-SET PERFORMANCE 66	H 600 mm - Ø 600 mm
PRE-SET PERFORMANCE 68	H 800 mm - Ø 600 mm

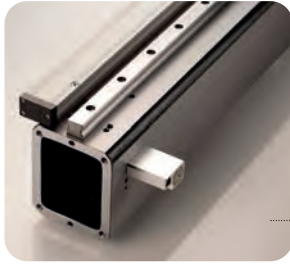

AXIS Z: Oversize, heavy duty, steel column. Thermally stabilized. SP class precision linear guide and preloaded with recirculating bearings. Linearity of movement is guaranteed by **1 guide with four-row linear recirculating ball bearing** with preloaded slides. It is equipped with glass optical scale with **micrometric resolution (0,001)** and supplied with their inspection certificate.



AXIS X: Stabilized steel plate, ground to a ± 2 planarity. Guides are directly fixed to the steel base of the presetter to guarantee constant geometry alignment. Linearity of movement is guaranteed by **2 parallel guides with four-row linear recirculating ball bearing** with preloaded slides. Guides are directly fixed to the steel base of the presetter to guarantee constant geometry alignment. It is equipped with glass optical scale with **micrometric resolution (0,001)** and supplied with their inspection certificate.



Monitor full HD 24"

Interchangeable tool sleeves are made in tempered steel with high precision (internal cone run-out $\pm 2\mu$). **Calibration spheres** integrated in the tool sleeve for fast and precise zero setting.



I - TECH SOFTWARE C.V.S. - FULL (Conti Vision System)
Software is the interface between the presetter and the user. The software is based on a high performance PC with last generation Windows® operating system.



Model	Dimensions	Weight	Power
44	A 1167-P 600-H 1757 mm	260 kg	230 V (optional 110V)
45	A 1167-P 600-H 1857 mm	265 kg	
46	A 1167-P 600-H 1957 mm	270 kg	
65	A 1267-P 600-H 1857 mm	295 kg	
66	A 1267-P 600-H 1957 mm	300 kg	
68	A 1267-P 600-H 1957 mm	310 kg	

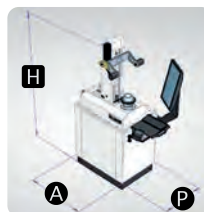

CRATE



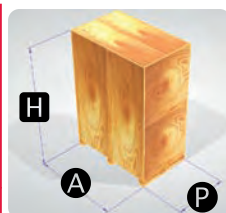









Model	Dimensions	Weight
44	A 1420-P 880-H 2000 mm	350 kg
45	A 1420-P 880-H 2100 mm	355 kg
46	A 1420-P 880-H 2200 mm	365 kg
65	A 1520-P 880-H 2100 mm	390 kg
66	A 1520-P 880-H 2200 mm	395 kg
68	A 1520-P 880-H 2200 mm	405 kg



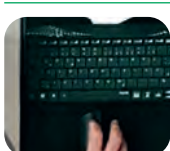

SPARE CONE-HOLDERS

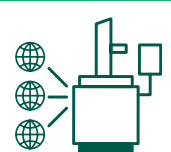
Item	Description
PRE-SET BL.ISO 30	for tool holders ISO 30
PRE-SET BL.ISO 40	for tool holders ISO 40
PRE-SET BL.ISO 50	for tool holders ISO 50
PRE-SET BL.HSK 63F	for tool holders HSK 63F/D/B
PRE-SET BL.HSK 63A	for tool holders HSK 63A/C/E
PRE-SET BL.HSK 80A	for tool holders HSK 80
PRE-SET BL.30x130	with arbor L=130, for tools with bore d= 30
PRE-SET BL.30x300	with arbor L=300, for tools with bore d= 30
PRE-SET BL.35x130	with arbor L=130, for tools with bore d= 35
PRE-SET BL.35x300	with arbor L=300, for tools with bore d= 35
PRE-SET BL.40x130	with arbor L=130, for tools with bore d= 40
PRE-SET BL.40x300	with arbor L=300, for tools with bore d= 40
PRE-SET BL.50x130	with arbor L=130, for tools with bore d= 50
PRE-SET BL.50x300	with arbor L=300, for tools with bore d= 50
PRE-SET BL.HS.HSK63	Cone holder for mechanical locking

PRODUCT FEATURES

 <p>The PERFORMANCE range is equipped, as a standard, with Interlock System. The system is flexible and can be used with the vast majority of standard pull studs. Tool sleeve rotation brake is also a standard feature.</p>	 <p>Pneumatic axis movement allows fast and precise positioning of the camera thanks to a button on the ergonomic handle.</p>	 <p>Two manual wheels allows micrometric movement of both Z and X axis for best precision and accuracy.</p>
 <p>Camera is a high-resolution CMOS camera with telecentric lenses. It offers a field of view of 7x7 mm (0,27"x0,27") in both Profile View and Real View mode and 40x enlargement.</p>	 <p>High Performance dust guards maintain the presetter guides and sliders in perfect shape at all times. The presetter can work in difficult conditions.</p>	 <p>LED ring cold light for the frontal illumination of tool surface. Light intensity regulation is possible.</p>
 <p>A height adjustable support tray holds the wireless mouse and keyboard becoming an efficient work station.</p>	 <p>A label printer supplied in order to print relevant tool data.</p>	 <p>PC with last generation Microsoft® operating system. Data saved to SSD hard drive.</p>
 <p>LAN connection to transfer data through a company network directly to machine tools.</p>	 <p>Connection to other tool data transmission systems such as BALLUFF® is also possible as well as Teleservice diagnostics.</p>	 <p>A big service cabinet has been created below the Preset. Easy to access it is an easy way to have equipment protected but all within reach.</p>

OPTIONAL

 <p>Item PRE-SET BL.HS.HSK63 Cone holder HSK63 for mechanical locking with Interlock System.</p>	 <p>Item PRESET 105 22" touch screen (To be included at the time of order and replace the standard)</p>
--	--

SOFTWARE - CONTI VISION SYSTEM

ALL DATA IN ONE VIEW

Simple, multi-language and intuitive the CONTI VISION SYSTEM software is easy for everyone. All functions are visualized, with easy to understand icons. It is possible to create up to 200 machine origins and memorize 200 tools for each machine. The tool measuring interface works like a real CAD and **any tool measure can be acquired**. The new **DXF function** allows the user to compare tool profiles against imported files or to scan and acquire a tool geometry. The new **GHOST function** permits to measure the maximum diameter and profile simply rotating the tool. **Real view tool inspection mode** clear, 40x enlargement, view of tool surface.

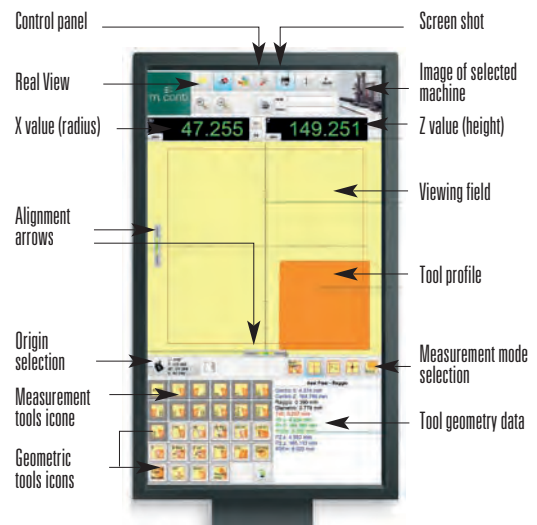
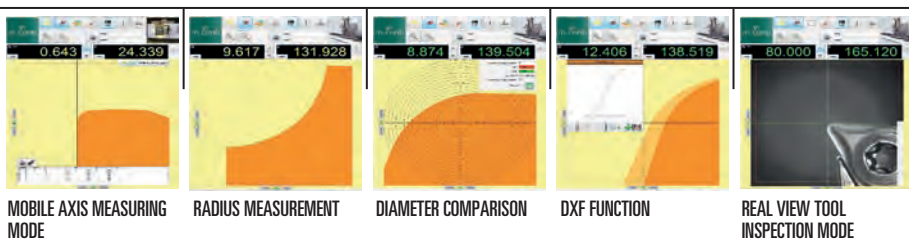

CONNECTIVITY

LAN connection to transfer data through a company network directly to machine tools. Connection to other tool data transmission systems such as BALLUFF® is also possible as well as Teleservice diagnostics.

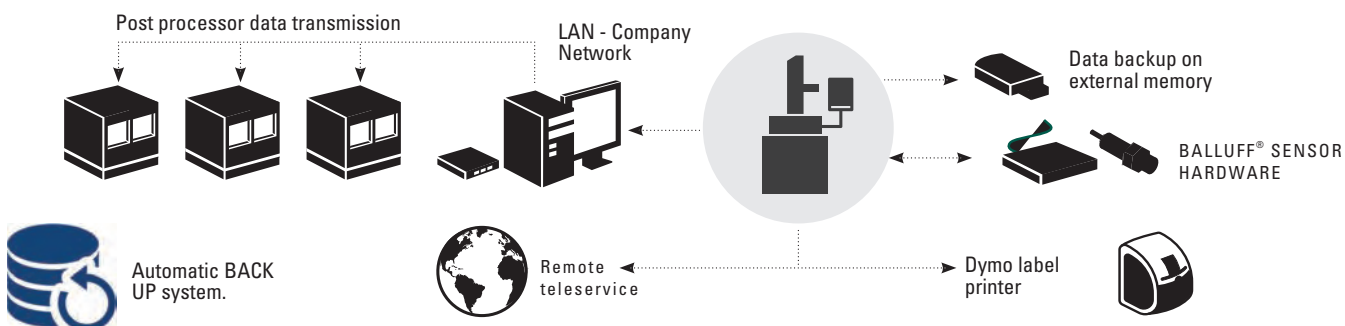

PRE SET LEADER PLUS

Preset LEADER Plus are high precision instruments performing high technology operations. Their structure is guaranteed by best quality components along with an interface very simple and intuitive to use. Designed and developed in the field of tooling manufacture, the **preset LEADER Plus** are also essential in sharpening centers and production units of furniture or windows, for checking the condition of the tools and their settings before being mounted in the machine. In recent years the family of the **preset LEADER Plus** has increased thanks to additional models with new combinations of diameter and height, satisfying most of the needs of market operators. **The preset LEADER Plus** is supplied with a cone-holder HSK63F.



The **structure** is entirely made in steel and ensures greater strength and hardness as well as extreme size accuracy and straightness. It is normalized for improved strength and dimensional stability in time.



Linearity of movement is guaranteed by **2 parallel linear guides on the X Axis** with four-row linear recirculating ball bearing with preloaded slides. **1 guide is used on the Z axis.** Guides are directly fixed to the steel base of the presetter to guarantee constant geometry alignment. Both X and Z axis are equipped with glass optical scales with a resolution (0,001) and supplied with their inspection certificate

Item	Measuring range
PRE-SET LEADER Plus 44	H 400 mm - Ø 400 mm
PRE-SET LEADER Plus 45	H 500 mm - Ø 400 mm
PRE-SET LEADER Plus 46	H 600 mm - Ø 400 mm



Monitor full HD da 22"

Interchangeable tool sleeves are made in tempered steel with high precision (internal cone run-out $\pm 2\mu$). **Calibration spheres integrated** in the tool sleeve for fast and precise zero setting.



SPARE CONE-HOLDERS

Item	Description
PRE-SET BL.ISO 30	for tool holders ISO 30
PRE-SET BL.ISO 40	for tool holders ISO 40
PRE-SET BL.ISO 50	for tool holders ISO 50
PRE-SET BL.HSK 63F	for tool holders HSK 63F/D/B
PRE-SET BL.HSK 63A	for tool holders HSK 63A/C/E
PRE-SET BL.HSK 80A	for tool holders HSK 80
PRE-SET BL.30x130	with arbor L=130, for tools with bore d= 30
PRE-SET BL.30x300	with arbor L=300, for tools with bore d= 30
PRE-SET BL.35x130	with arbor L=130, for tools with bore d= 35
PRE-SET BL.35x300	with arbor L=300, for tools with bore d= 35
PRE-SET BL.40x130	with arbor L=130, for tools with bore d= 40
PRE-SET BL.40x300	with arbor L=300, for tools with bore d= 40
PRE-SET BL.50x130	with arbor L=130, for tools with bore d= 50
PRE-SET BL.50x300	with arbor L=300, for tools with bore d= 50
PRE-SET BL.HS.HSK63	Cone holder for mechanical locking

Leader Plus	Dimensions	Weight	Power
44	A 1080-P 626-H 950 mm	136 kg	230 V (optional 110V)
45	A 1080-P 626-H 1050 mm	142 kg	
46	A 1080-P 626-H 1150 mm	148 kg	

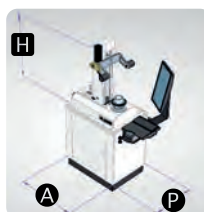

CRATE

Leader Plus	Dimensions	Weight
44	A 1180-P 820-H 1210 mm	182 kg
45	A 1180-P 820-H 1310 mm	189 kg
46	A 1180-P 820-H 1410 mm	196 kg

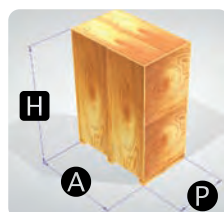

PRODUCT FEATURES



Camera is a high-resolution C-MOS camera with telecentric lenses. It offers a **field of view of 7x7 mm (0,27"x0,27")** in both Profile View and Real View mode and 40x enlargement.



Pneumatic axis movement allows fast and precise positioning of the camera thanks to a button on the ergonomic handle, whereas two manual wheels allow **micrometric movement** of both Z and X axis for best precision and accuracy.



Cold light LED ring illuminator. Light intensity regulation is possible.

OPTIONAL

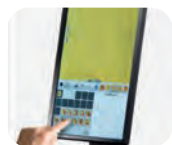

Item **PRESET 105**
22" touch screen
(To be included at the time of order and replace the standard).



Item **PRESET 099**
Holding cart,
dimensions 810x560xH720 cm



Item **PRESET 103**
Labor printer Dymo 450



Item **PRESET 101**
Interlock System
(no ISO 30)

Item **PRESET 102**
Interlock retaining pawls



Item **PRE-SET BL.HS.HSK63**
Cone holder HSK63 for
mechanical locking with
Interlock System.



Item **PRESET 100**
DXF Software
Allow to import/export create
and compare a DXF drawing.

SOFTWARE - CONTI VISION SYSTEM

ALL DATA IN ONE VIEW

Simple, multi-language and intuitive the CONTI VISION SYSTEM software is easy for everyone. All functions are visualized, with easy to understand icons. It is possible to create up to 200 machine origins and memorize 200 tools for each machine. The tool measuring interface works like a real CAD and **any tool measure can be acquired**. The new **DXF function (optional)** allows the user to compare tool profiles against imported files or to scan and acquire a tool geometry. The new **GHOST function** permits to measure the maximum diameter and profile simply rotating the tool. **Real view tool inspection mode** clear, 40x enlargement, view of tool surface.

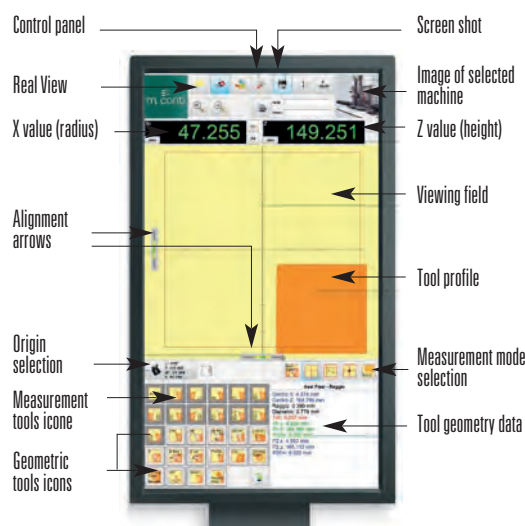
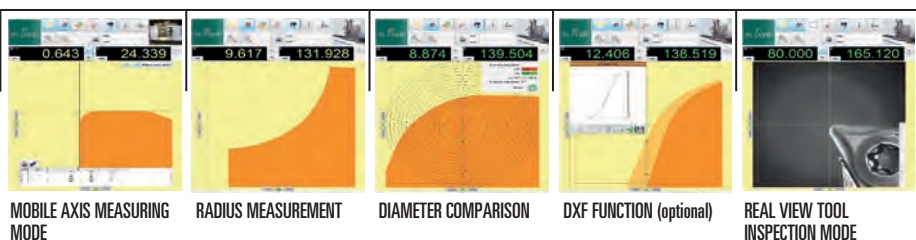

CONNECTIVITY

LAN tools connectivity to company network for tool data transmission using Post Processor. Possibility of TELESERVICE. Connection to other data transmission systems, such as BALLUFF® (optional) for example, is also possible.

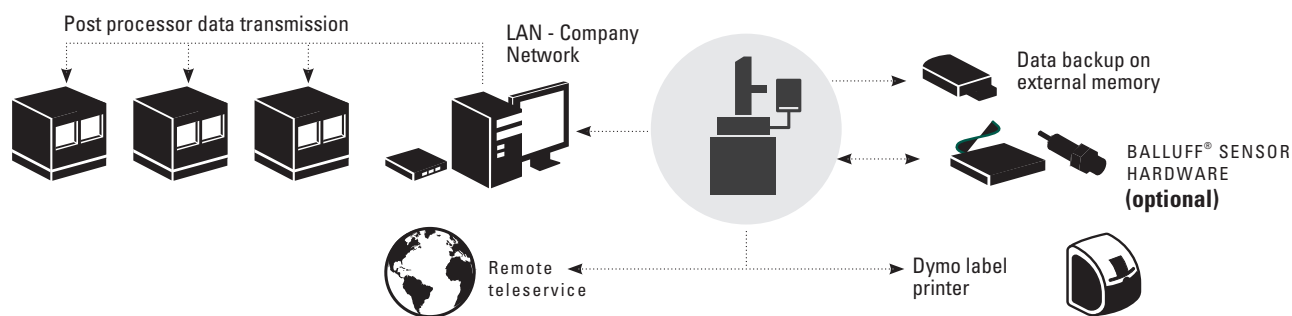

A project must also consider the customer's need for safety and easy of use. This is why our presetter are equipped with removable transport handles which make any necessary movement easy and safe.

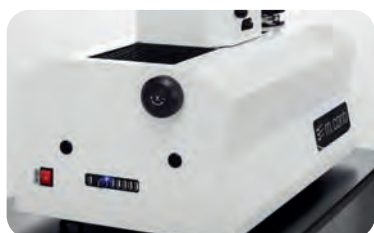

PRE SET UNIKO

Fully equipped, sturdy and extremely easy to use. Entering the world of camera presetting is easy with this user friendly presetter. Designed and developed in the field of tooling manufacture, the **preset UNIKO** are also essential in sharpening centers and production units of furniture or windows, for checking the condition of the tools and their settings before being mounted in the machine. Powerful Post Processor to easily integrate in any working condition. **The preset UNIKO** is supplied with a cone-holder HSK63F.



The **structure** is entirely made in steel and ensures greater strength and hardness as well as extreme size accuracy and straightness. It is normalized for improved strength and dimensional stability in time.



Linearity of movement is guaranteed by **2 parallel linear guides on the X Axis** with four-row linear recirculating ball bearing with preloaded slides. **1 guide is used on the Z axis.** Guides are directly fixed to the steel base of the presetter to guarantee constant geometry alignment. Both X and Z axis are equipped with glass optical scales with a resolution (0,001) and supplied with their inspection certificate

Item	Measuring range
PRE-SET UNIKO 44	H 400 mm - Ø 400 mm
PRE-SET UNIKO 45	H 500 mm - Ø 400 mm



Interchangeable tool sleeves are made in tempered steel with high precision (internal cone run-out $\pm 2\mu$). **Calibration spheres** integrated in the tool sleeve for fast and precise zero setting.



Uniko	Dimensions	Weight	Power
44	A 1080-P 626-H 950 mm	136 kg	230 V
45	A 1080-P 626-H 1050 mm	142 kg	(optional 110V)

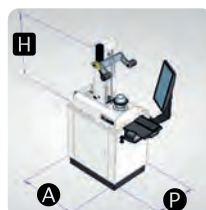

CRATE

Uniko	Dimensions	Weight
44	A 1180-P 820-H 1210 mm	182 kg
45	A 1180-P 820-H 1310 mm	189 kg

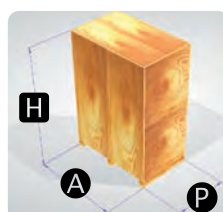

SPARE CONE-HOLDERS

Item	Description
PRE-SET BL.ISO 30	for tool holders ISO 30
PRE-SET BL.ISO 40	for tool holders ISO 40
PRE-SET BL.ISO 50	for tool holders ISO 50
PRE-SET BL.HSK 63F	for tool holders HSK 63F/D/B
PRE-SET BL.HSK 63A	for tool holders HSK 63A/C/E
PRE-SET BL.HSK 80A	for tool holders HSK 80
PRE-SET BL.30x130	with arbor L=130, for tools with bore d= 30
PRE-SET BL.30x300	with arbor L=300, for tools with bore d= 30
PRE-SET BL.35x130	with arbor L=130, for tools with bore d= 35
PRE-SET BL.35x300	with arbor L=300, for tools with bore d= 35
PRE-SET BL.40x130	with arbor L=130, for tools with bore d= 40
PRE-SET BL.40x300	with arbor L=300, for tools with bore d= 40
PRE-SET BL.50x130	with arbor L=130, for tools with bore d= 50
PRE-SET BL.50x300	with arbor L=300, for tools with bore d= 50

PRODUCT FEATURES



Camera is a high-resolution C-MOS camera with telecentric lenses. It offers a **field of view of 5x5mm** (0,20" x 0,20") in both Profile View and Real View mode and 40x enlargement.



Axis movement is manual and allows fast and precise positioning of the camera with two possibilities: fast movement and micrometric movement.



Two manual wheels allows **micrometric movement** of both Z and X axis for best precision and accuracy.



Cold light LED ring illuminator.

OPTIONAL



Item **PRESET 099**
Holding cart, dimensions 810x560xH720 cm



Item **PRESET 103**
Laser printer Dymo 450

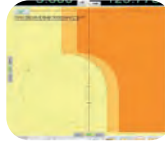

Item **PRESET 106**
Tool Pack additional software package

SOFTWARE - CONTI VISION SYSTEM

ALL DATA IN ONE VIEW

Simple, multi-language and intuitive the CONTI VISION SYSTEM software is easy for everyone. All functions are visualized, with easy to understand icons. It is possible to create up to 200 machine origins and memorize 200 tools for each machine. The tool measuring interface works like a real CAD and **any tool measure can be acquired**. The new **GHOST function available with our Tool Pack (optional)** permits to measure the maximum diameter and profile simply rotating the tool. **Real view tool inspection mode** clear, 40x enlargement, view of tool surface.

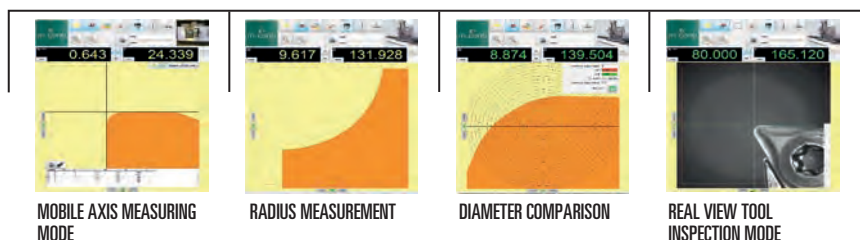
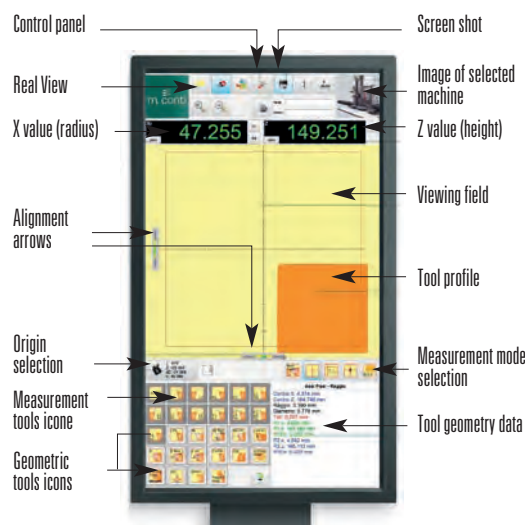

CONNECTIVITY

LAN connectivity to company network for tool data transmission using Post Processor. Possibility of TELESERVICE.

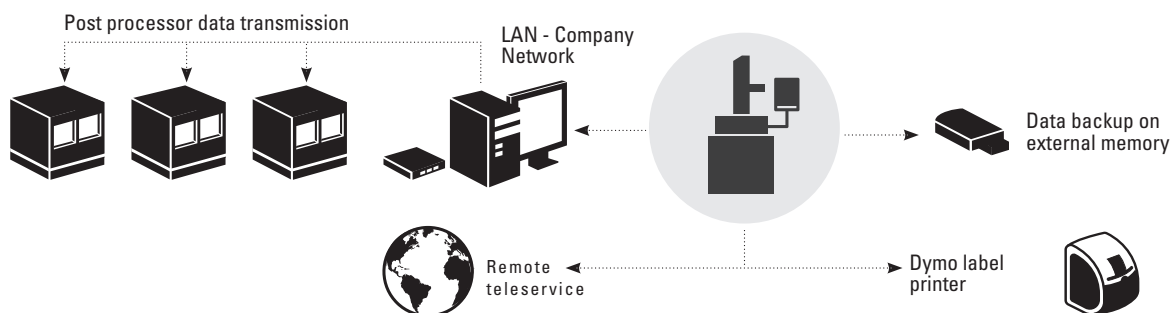

A project must also consider the customer's need for safety and easy of use. This is why our presetter are equipped with removable transport handles which make any necessary movement easy and safe.

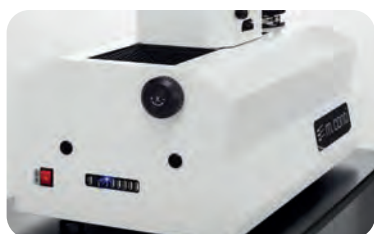

PRE SET PRIME

Fully equipped, sturdy and easy to use. The world of camera presetting is within reach with this user friendly presetter. Checking tool geometry is easy and intuitive. **The preset PRIME** is supplied with a cone-holder HSK63F.



The **structure** is entirely made in steel and ensures greater strength and hardness as well as extreme size accuracy and straightness. It is normalized for improved strength and dimensional stability in time.

Item	Measuring range
PRE-SET PRIME 32/40	H 400 mm - Ø 320 mm



Interchangeable tool sleeves with reference notch ISO-BT / HSK / CAPTO (no reference shafts required)

LCD Monitor 19"



Prime	Dimensions	Weight	Power
32/40	A 870-P 516-H 880 mm	90 kg	230 V/110V)

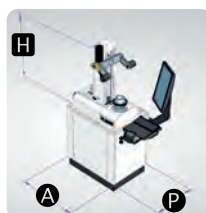

CRATE

Prime	Dimensions	Weight
32/40	A 1020-P 720-H 1080 mm	131 kg

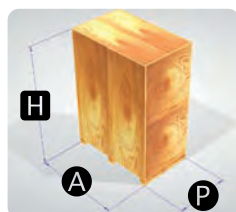

SPARE CONE-HOLDERS

Item	Description
PRE-SET BL.ISO 30	for tool holders ISO 30
PRE-SET BL.ISO 40	for tool holders ISO 40
PRE-SET BL.ISO 50	for tool holders ISO 50
PRE-SET BL.HSK 63F	for tool holders HSK 63F/D/B
PRE-SET BL.HSK 63A	for tool holders HSK 63A/C/E
PRE-SET BL.HSK 80A	for tool holders HSK 80
PRE-SET BL.30x130	with arbor L=130, for tools with bore d= 30
PRE-SET BL.30x300	with arbor L=300, for tools with bore d= 30
PRE-SET BL.35x130	with arbor L=130, for tools with bore d= 35
PRE-SET BL.35x300	with arbor L=300, for tools with bore d= 35
PRE-SET BL.40x130	with arbor L=130, for tools with bore d= 40
PRE-SET BL.40x300	with arbor L=300, for tools with bore d= 40
PRE-SET BL.50x130	with arbor L=130, for tools with bore d= 50
PRE-SET BL.50x300	with arbor L=300, for tools with bore d= 50

PRODUCT FEATURES



Camera is a high-resolution C-MOS camera with telecentric lenses. It offers a **field of view of 5x5mm** (0,20" x 0,20") in both Profile View and Real View mode and 40x enlargement.



Perfect balance of the support column allows smooth, effortless movement. The handle is comfortable and easy to grip. Manual axis movement.



LED lighting system for tool inspection.



Two big manual wheels allows micrometric movement of both Z and X axis for best precision and accuracy.

OPTIONAL



Item **PRESET 099.2**
Holding cart,
dimensions
810x560xH920 cm



Item **PRESET 103**
Label printer
Dymo 450

SOFTWARE - CONTI VISION SYSTEM

ALL DATA IN ONE VIEW

Simple, multi-language and intuitive the CONTI VISION SYSTEM software is easy for everyone. All functions are visualized, with easy to understand icons. Uploading a picture of a machine tool, creating up to 50 machine origins and memorizing 100 tools for each machine has never been so fast and easy. The tool measuring interface works like a real CAD and **any tool measure can be acquired**.

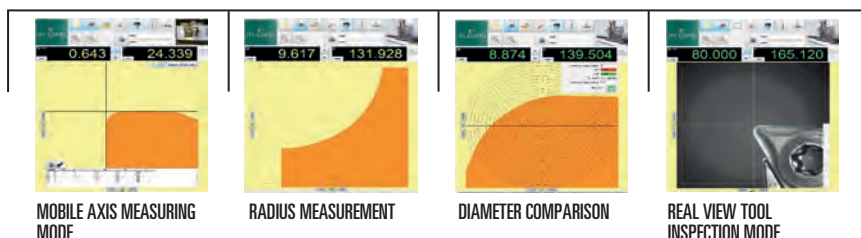
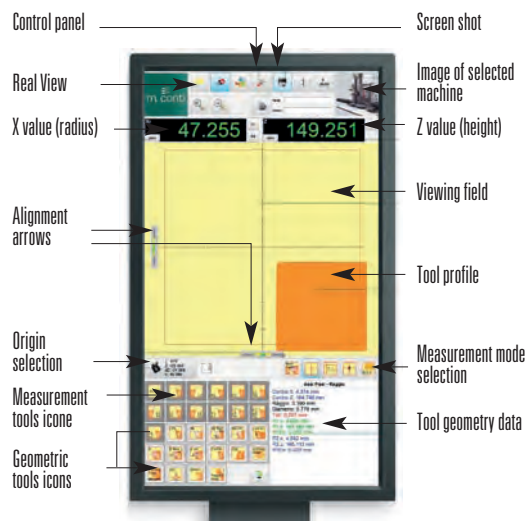

CONNECTIVITY

The Connectivity Pack (**optional**) is a powerful software with tool list compiling capabilities. A library of over 50 Post Processor allow the creation of CNC tool update files.

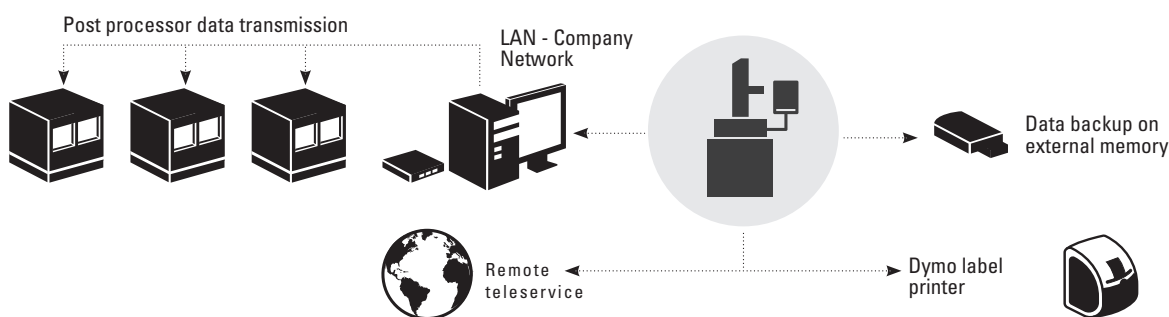

A project must also consider the customer's need for safety and easy of use. This is why our presetter are equipped with removable transport handles which make any necessary movement easy and safe.



PRE SET P368LR

The **Preset P368LR** is a precision tool setting instrument, easy and quick to use, especially designed to meet the requirements of the NC machine operators. It is mainly used in the wood, metal and glass working field where there is a constant need to set or adjust the tools. The **Preset P368LR** measures both the radius/diameter and the length/height of the tools. Working with different tool holders or various machines can be possible by setting up to 4 origins. The measures shown in the display can be set directly in the machine and the production quickly starts again.

Item	Measuring range
PRE-SET P368LR	H 300 mm - Ø 250 mm
PRE-SET P368LR/HSK63F	H 300 mm - Ø 250 mm

Axis Z
Slide guide in anti-friction material.

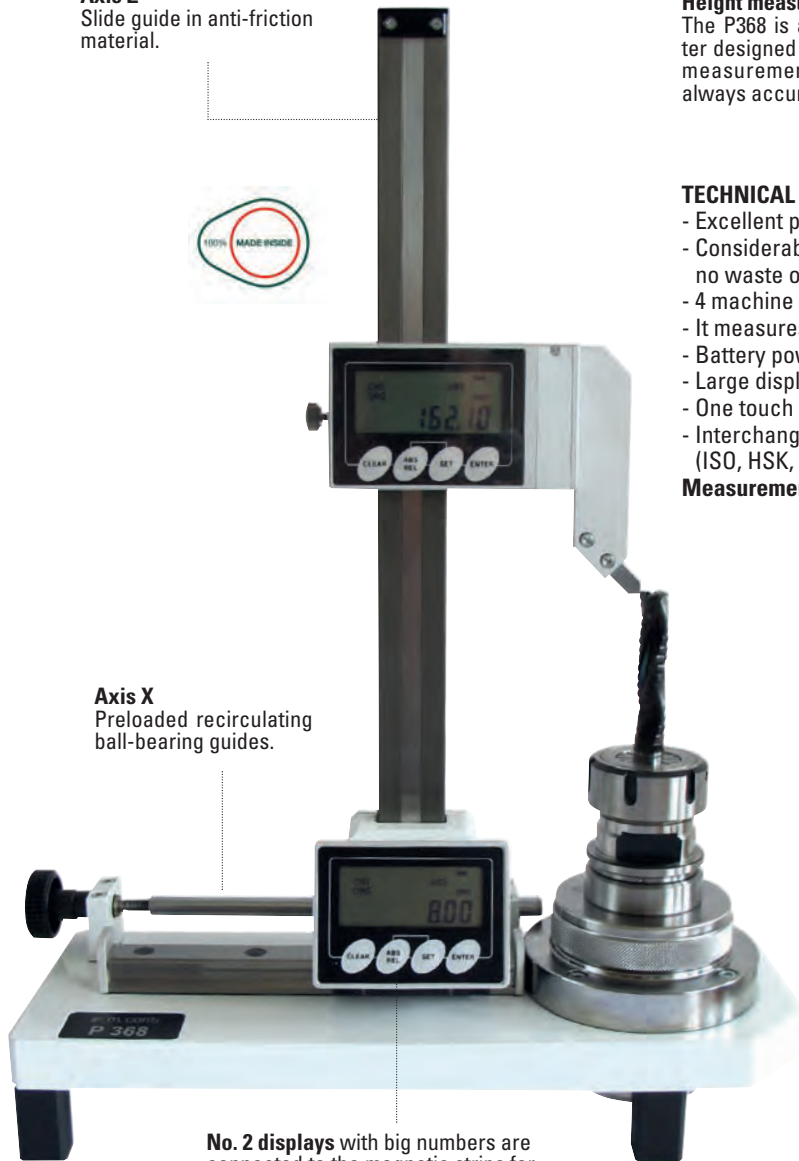

Axis X
Preloaded recirculating ball-bearing guides.

No. 2 displays with big numbers are connected to the magnetic strips for measurements detection of axis X and Z.



Height measurement
The P368 is a very solid presetter designed to make tool height measurement very simple and always accurate.



Diameter measurement
The P368 has a solid base and provides smooth and accurate linear movements. The tool radius/diameter is always precise.

TECHNICAL FEATURES

- Excellent price/quality relationship
- Considerable cutback of tooling-up times, no waste of material
- 4 machine origins
- It measures all types of tools
- Battery powered – no need of electrical plug
- Large display easy to read
- One touch conversion mm/inch
- Interchangeable cone holders (ISO, HSK, VDI, arbors)

Measurement detection: Precision magnetic strip

Item
T. SFERA-P368



Spherical feeler for shaped cutters (Optional)



SPARE CONE-HOLDERS

The **preset P368LR** is supplied with a cone-holder (ISO30, ISO40, ISO50) on your choice. The **Preset P368LR/HSK63F** is supplied with an HSK63F cone holder included. Other cone-holders can also be purchased later.

Item	Description
PRE-SET B.ISO 30	for tool holders ISO 30
PRE-SET B.ISO 40	for tool holders ISO 40
PRE-SET B.ISO 50	for tool holders ISO 50
PRE-SET B.HSK 63F	for tool holders HSK 63F/D/B
PRE-SET B.HSK 63A	for tool holders HSK 63A/C/E
PRE-SET B.HSK 80A	for tool holders HSK 80
PRE-SET B.30x130	with arbor L=130, for tools with bore d= 30
PRE-SET B.30x300	with arbor L=300, for tools with bore d= 30
PRE-SET B.35x130	with arbor L=130, for tools with bore d= 35
PRE-SET B.35x300	with arbor L=300, for tools with bore d= 35
PRE-SET B.40x130	with arbor L=130, for tools with bore d= 40
PRE-SET B.40x300	with arbor L=300, for tools with bore d= 40
PRE-SET B.50x130	with arbor L=130, for tools with bore d= 50
PRE-SET B.50x300	with arbor L=300, for tools with bore d= 50

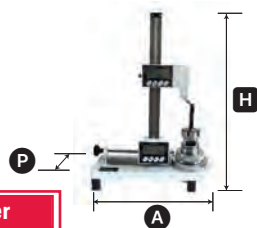

P368	Dimensions	Weight	Power
LR	A 410-P 150-H 540 mm	12 kg	2 AA Batteries each display (included)

CRATE

P368	Dimensions	Weight
LR	A 610-P 485-H 210 mm	15,3 kg

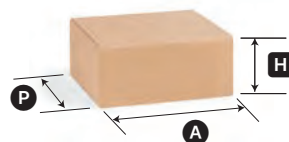

PRE SET P368XL

The **Preset P368XL** is a precise instrument, easy and quick to use: these characteristics have been especially designed to meet the requirements of the NC machine operator. It is used in the wood, metal and glass machining industries where the tools must be pre-set or adjusted. The **Preset P368XL**, can be used for both measuring lengths and radius of the tools. The **Preset P368XL** is necessary when working with tools with diameter up to 400 mm.

Item	Measuring range
PRE-SET P368XL	H 300 mm - Ø 400 mm



Height measurement
The P368 is a very solid presetter designed to make tool height measurement very simple and always accurate.



Diameter measurement
The P368 has a solid base and provides smooth and accurate linear movements. The tool radius/diameter is always precise.

Axis Z
Slide guide in anti-friction material.



TECHNICAL FEATURES

- Excellent price/quality relationship
- Considerable cutback of tooling-up times, no waste of material
- 4 machine origins
- It measures all types of tools
- Battery powered – no need of electrical plug
- Large display easy to read
- One touch conversion mm/inch
- Interchangeable cone holders (ISO, HSK, VDI, arbors)

Measurement detection: Precision magnetic strip

Item
T. SFERA-P368



Spherical feeler for shaped cutters (Optional)

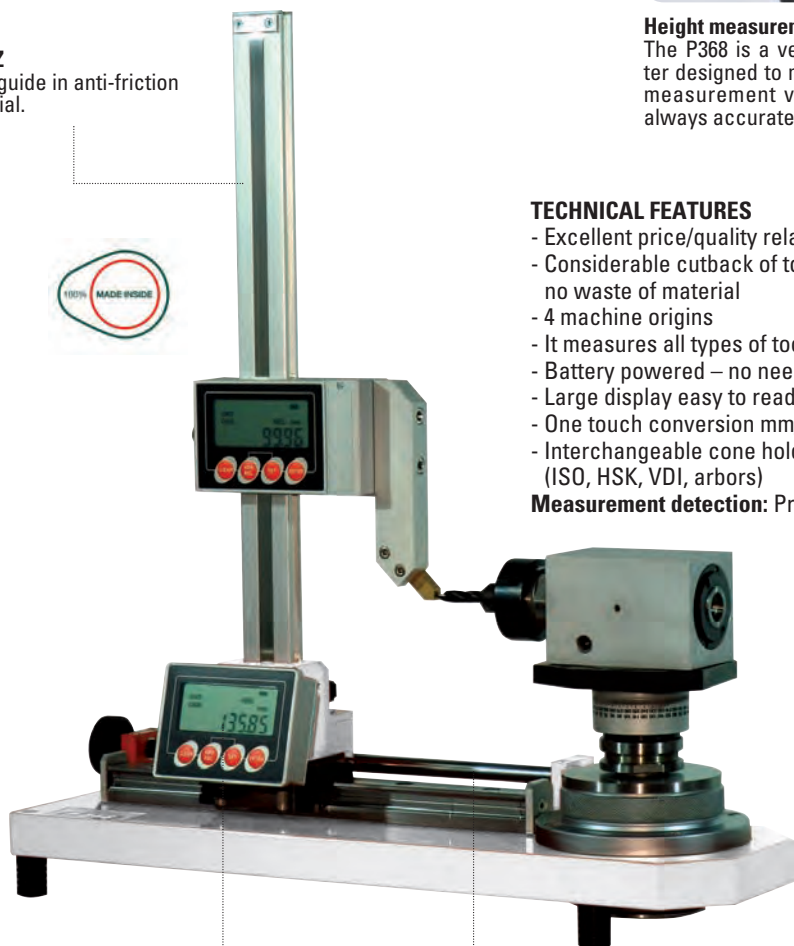

No. 2 displays with big numbers are connected to the magnetic strips for measurements detection of axis X and Z.

Axis X
Preloaded recirculating ball-bearing guides.



The preset **P368XL** is supplied with a cone-holder (ISO30, ISO40, ISO50) on your choice. Other cone-holders can also be purchased later.

SPARE CONE-HOLDERS

Item	Description
PRE-SET B.ISO 30	for tool holders ISO 30
PRE-SET B.ISO 40	for tool holders ISO 40
PRE-SET B.ISO 50	for tool holders ISO 50
PRE-SET B.HSK 63F	for tool holders HSK 63F/D/B
PRE-SET B.HSK 63A	for tool holders HSK 63A/C/E
PRE-SET B.HSK 80A	for tool holders HSK 80
PRE-SET B.30x130	with arbor L=130, for tools with bore d= 30
PRE-SET B.30x300	with arbor L=300, for tools with bore d= 30
PRE-SET B.35x130	with arbor L=130, for tools with bore d= 35
PRE-SET B.35x300	with arbor L=300, for tools with bore d= 35
PRE-SET B.40x130	with arbor L=130, for tools with bore d= 40
PRE-SET B.40x300	with arbor L=300, for tools with bore d= 40
PRE-SET B.50x130	with arbor L=130, for tools with bore d= 50
PRE-SET B.50x300	with arbor L=300, for tools with bore d= 50

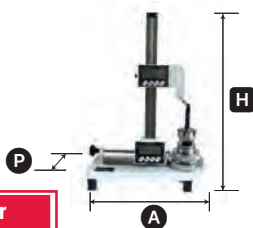

P368	Dimensions	Weight	Power
XL	A 490-P 200-H 580 mm	33 kg	2 AA Batteries each display (included)

CRATE

P368	Dimensions	Weight
XL	A 700-P 570-H 380 mm	40 kg

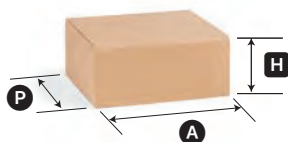

ANGOLFAST - The right instruments for measuring angles



Angolfast is made of anodized aluminium, so it is very sturdy but at the same time light and easy to use. It features a shockproof spirit-level and can measure inner angles between 20-135°.

Item	Dimension
ANGOLFAST 45	450 mm
ANGOLFAST 70	700 mm

ANGOLFAST 70S	700 mm with reference shoulder
	Angolfast 70S with reference shoulder for easier outlining



These in brief are the characteristics of this instrument, useful for:
INTERIOR DECORATORS - KITCHEN UNIT MANUFACTURERS - FRAME INSTALLERS
BRICKLAYERS - CARPENTERS - SMITHS - SURVEYORS - ARCHITECTS

**PRECISE
STURDY
VERSATILE
LIGHT
HANDY
SIMPLE**



PRE SET P322 - The radius measuring stand is a precision device of simple and quick use, suitable to measure the radius of profiled cutterheads. Before mounting the tools in a machine it is absolutely important to know the correct dimensions of the cutter and set them in order to start the production without any additional concerns. The **Preset P322** was designed and developed in collaboration with technicians who work daily with these type of tools, having troubles with setting operations. The result is an optimization of the production and a good saving of time. The **Preset P322** is the best accessory beside a moulding or a CNC machine.

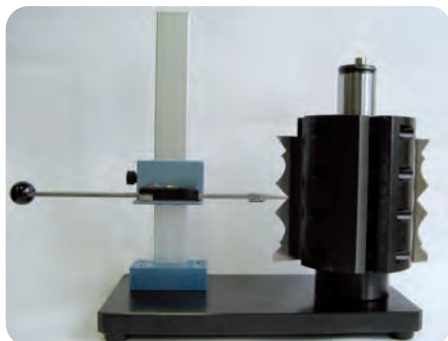

Main features
 Arbor height: 230 mm
 R max (cutterhead radius): 120 mm

Item	Ø Arbor	Height	R max
PRE-SET P322/30	30	230	120
PRE-SET P322/35	35	230	120
PRE-SET P322/40	40	230	120
PRE-SET P322/32	1" 1/4"	230	120
PRE-SET P322/38	1" 1/2"	230	120
PRE-SET P322/46	1" 13/16"	230	120



Digital readout:
 - Resolution: 0,01 mm
 - Readout in mm/inches
 - Battery-power (SR44)
 - Operating temperature range: 0/+40°
 - Storage temperature range: -10/+60°
 - Umidity: ≤ 80%

THREE POINT DIGITAL CALIPER FOR CUTTERS Z=3

ART. C.DIGIT.Z3

Caliper for measuring the diameter of router bits with three cutting edges (our items T143/T144, T153/T154 and any cutter Z=3)

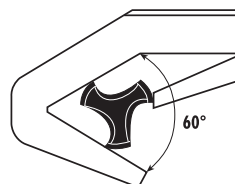

- Measuring range: 4 mm ÷ 40,00 mm / 0,16" ÷ 1,73"
 - Resolution: 0,01 mm/0,0005"
 - Accuracy: ± 0,05 mm/± 0,002"
 - Repeatability: 0,01 mm/0,0005"
 - Maximum measurement speed: 1,5 m/s - 60 in/s

- Operating temperature: 0°C÷40°C
 - Storage temperature: -10°C÷60°C
 - Power: 1,5V SR44 (silver oxide cell) - 1 battery
 - Battery life: 1 year continuous usage/
 3 years under normal operation

Item	Measuring range
C.DIGIT.Z3	4÷40 mm

GAUGES

Modern panel working production technologies have made indispensable the use of appropriate measuring instruments sufficiently precise to achieve high quality standards. The line of gauges shown below has been designed to meet all woodworking measurement needs and these gauges are commonly used even in the working of **aluminium, glass** and **sheet metals**. All the gauges are made of chromium-plate steel with inscribed scale and coloured black; **PRECISION** of **0,1 mm**.

GAUGE FOR LINEAR MEASUREMENTS

ART. C.LIN

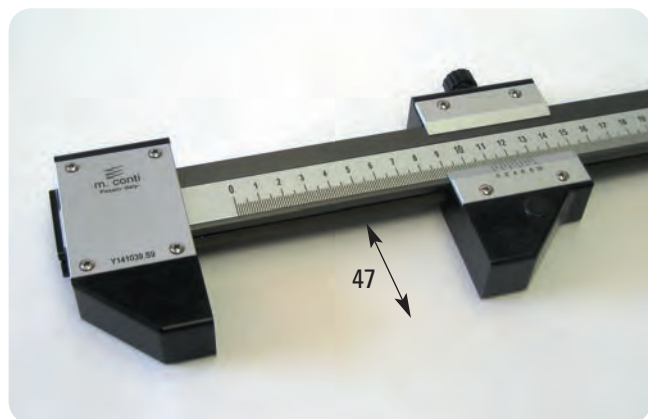

Suitable for measuring wood panel widths and lengths, but also for glass, aluminium profiles and sheet metal.



Item	Measuring range
C.LIN.0500	0÷500
C.LIN.0750	0÷750
C.LIN.1000	0÷1000
C.LIN.1500	0÷1500
C.LIN.2000	0÷2000
C.LIN.2500	0÷2500
C.LIN.3200	0÷3200

GAUGE FOR LINEAR MEASUREMENTS WITH STEEL PLATES

ART. C.LIN.PA

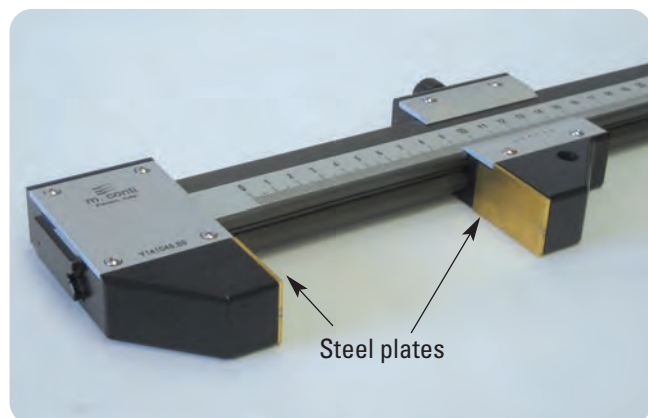

Suitable for measuring widths and lengths in glass, aluminium and sheet metal items.

Plates in TIN coated high resistance steel.

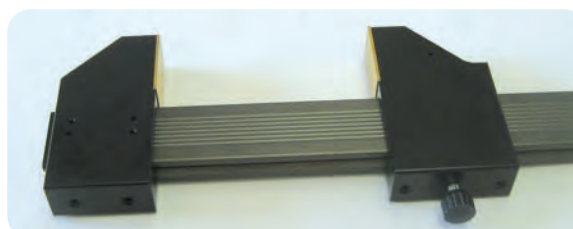

Item	Measuring range
C.LIN.PA0500	0÷500
C.LIN.PA0750	0÷750
C.LIN.PA1000	0÷1000
C.LIN.PA1500	0÷1500
C.LIN.PA2000	0÷2000
C.LIN.PA2500	0÷2500
C.LIN.PA3200	0÷3200

GAUGE FOR DISTANCE BETWEEN HOLES

ART. C.INT

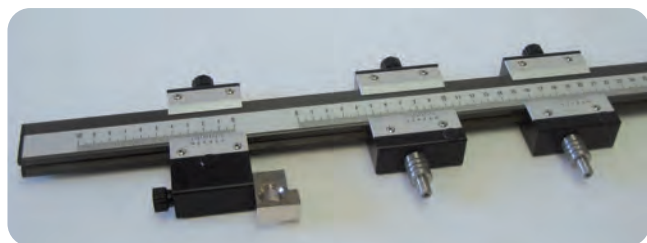





Practically indispensable for correctly measuring the distance from the edge of the panel to the centre of holes or the centre distance between one hole and another.
Supplied with one semi-fixed slider and two moving sliders with dia. 8 pin.



Item	Measuring range
C.INT0500	0÷500
C.INT0750	0÷750
C.INT1000	0÷1000
C.INT1500	0÷1500
C.INT2000	0÷2000
C.INT2500	0÷2500
C.INT3200	0÷3200

Spare parts

C.CORS.PER	Spare slider complete with pin	
C.PER.0415	Conical pin for dia. 4 - dia. 15 holes	
C.PERNO.03	For hole Ø 3	
C.PERNO.04	For hole Ø 4	
C.PERNO.05	For hole Ø 5	
C.PERNO.06	For hole Ø 6	
C.PERNO.07	For hole Ø 7	
C.PERNO.08	For hole Ø 8	
C.PERNO.09	For hole Ø 9	
C.PERNO.10	For hole Ø 10	
C.PERNO.12	For hole Ø 12	
C.PERNO.14	For hole Ø 14	
C.PERNO.15	For hole Ø 15	
C.PERNO.16	For hole Ø 16	
C.PERNO.18	For hole Ø 18	
C.PERNO.20	For hole Ø 20	
C.PERNO.25	For hole Ø 25	
C.PERNO.26	For hole Ø 26	
C.PERNO.30	For hole Ø 30	
C.PERNO.35	For hole Ø 35	

GAUGE FOR 90° V-FOLD CUTS

ART. C.INV

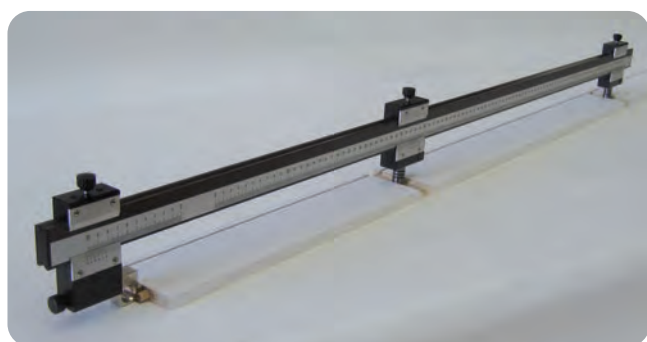

Suitable for the production of drawers, it features a semi-fixed slider and two moving sliders with V-90° pin.

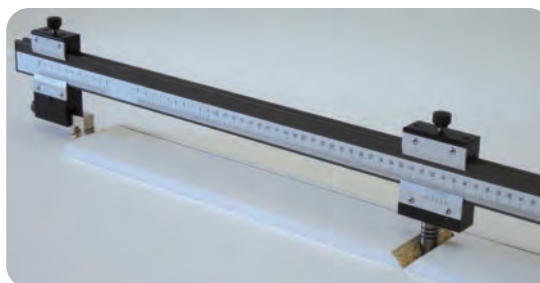

Item	Measuring range
C.INV1000	550÷0÷1000
C.INV1500	550÷0÷1500
C.INV2000	550÷0÷2000

Spare parts

C.CORS.V90°	Spare slider complete with pin
C.PERS.V90°	V-90° pin

GAUGE FOR INSIDE/OUTSIDE MEASURING

ART. C.LIE

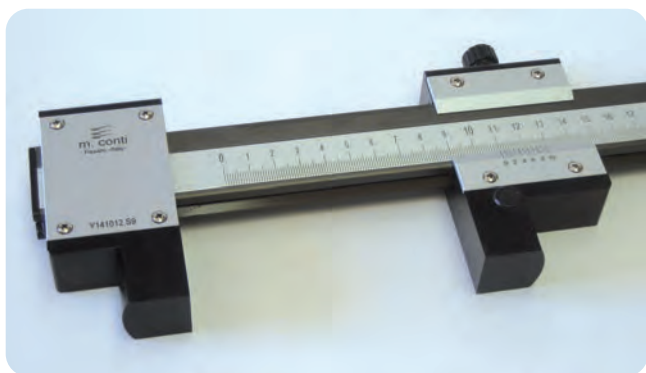

Suitable for measuring big dimension openings (min. 50 mm) on wood panels and frames. For inside measurings mm 50 is to be added.

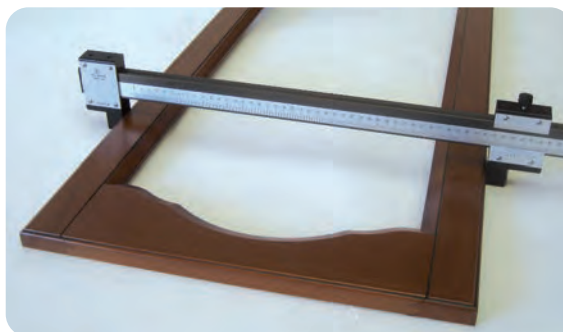
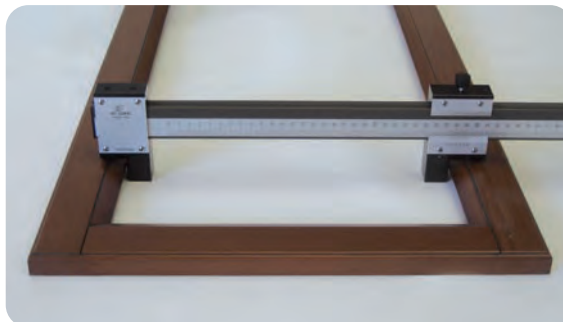

Item	Measuring range
C.LIE0500	0÷500
C.LIE0750	0÷750
C.LIE1000	0÷1000
C.LIE1500	0÷1500
C.LIE2000	0÷2000
C.LIE2500	0÷2500
C.LIE3200	0÷3200

GAUGE FOR INSIDE/OUTSIDE MEASURING WITH STEEL PLATES

ART. C.LIE.PA

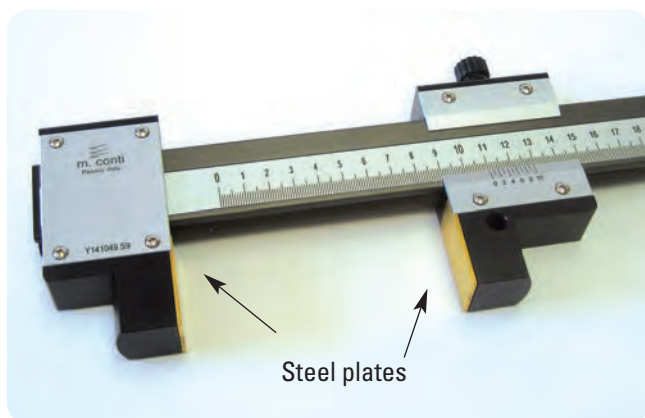

Suitable for measuring big dimension openings (min. 50 mm) on glass, alu, metal and PVC items.

Plates in TIN coated high resistance steel.

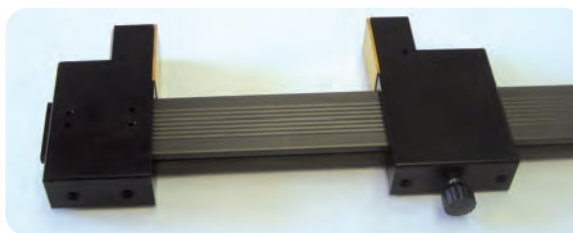

Item	Measuring range
C.LIE.PA0500	0÷500
C.LIE.PA0750	0÷750
C.LIE.PA1000	0÷1000
C.LIE.PA1500	0÷1500
C.LIE.PA2000	0÷2000
C.LIE.PA2500	0÷2500
C.LIE.PA3200	0÷3200

GAUGE FOR LINEAR MEASUREMENTS AND DISTANCE BETWEEN CENTRES

ART. C.LIN.PI

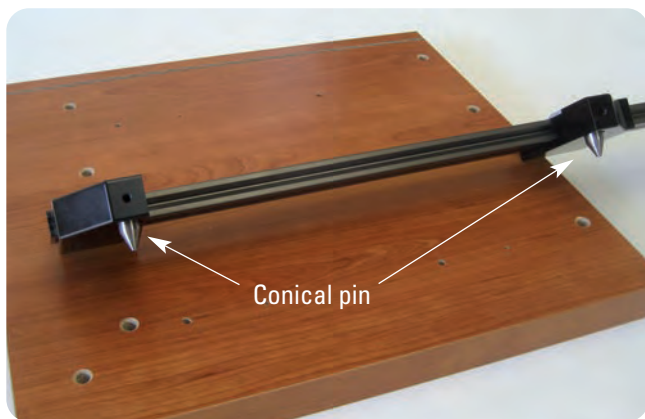

The length is read directly on the graduated scale, the hole distance is obtained by adding 20 mm to the value read on the scale. Two tapered pins are supplied as standard $\varnothing 4/\varnothing 15$ mm.



Item	Measuring range
C.LIN.PI0500	0÷500
C.LIN.PI0750	0÷750
C.LIN.PI1000	0÷1000
C.LIN.PI1500	0÷1500
C.LIN.PI2000	0÷2000
C.LIN.PI2500	0÷2500
C.LIN.PI3200	0÷3200

Spare parts

C.PER.1415	Conical pin for dia. 4 ÷ 15 holes
------------	-----------------------------------

GAUGE FOR LINEAR MEASUREMENTS, DISTANCE FROM THE CENTRES OF THE HOLE TO THE EDGE OF THE PANEL

ART. C.LIN.PB

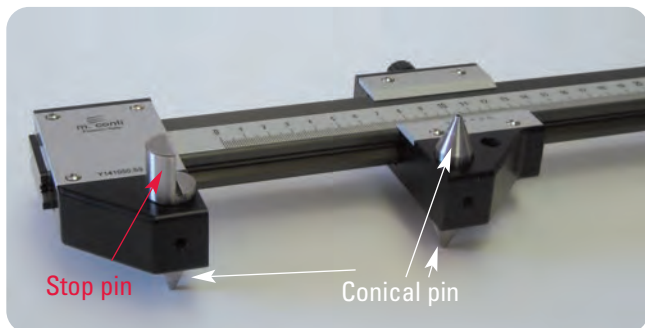

The length is read directly on the graduated scale, the hole distance is obtained by adding 20 mm to the value read on the scale.

Two pins are supplied as standard (one tapered of $\varnothing 4/\varnothing 15$ mm and one as stop). With the left pin the distance between the edge of the panel and the centre of the hole can be measured.



Measuring of the distance of panel edge to the hole centres

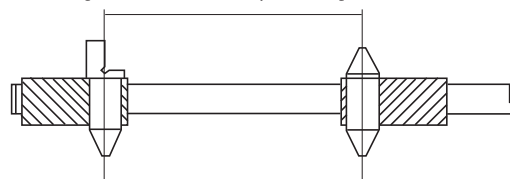

Measuring of distance between hole centres

Item	Measuring range
C.LIN.PB0500	0÷500
C.LIN.PB0750	0÷750
C.LIN.PB1000	0÷1000
C.LIN.PB1500	0÷1500
C.LIN.PB2000	0÷2000
C.LIN.PB2500	0÷2500
C.LIN.PB3200	0÷3200

Spare parts

C.PER.1415	Conical pin for dia. 4 ÷ 15 holes	
------------	-----------------------------------	--

C.PER.B12	Stop pin	
-----------	----------	---

GAUGE FOR LINEAR MEASUREMENTS, WITH LONG JAWS

ART. C.LIN.L

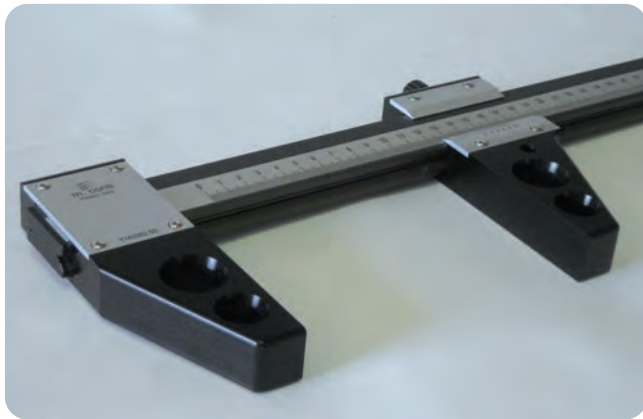

Suitable for measuring width and length of wood panel
JAW LENGTH 97 mm.

Item	Measuring range
C.LIN.L0500	0÷500
C.LIN.L0750	0÷750
C.LIN.L1000	0÷1000
C.LIN.L1500	0÷1500
C.LIN.L2000	0÷2000
C.LIN.L2500	0÷2500
C.LIN.L3200	0÷3200

GAUGE FOR LINEAR MEASUREMENTS, WITH LONG JAWS AND STEEL PLATES

ART. C.LIN.L.PA

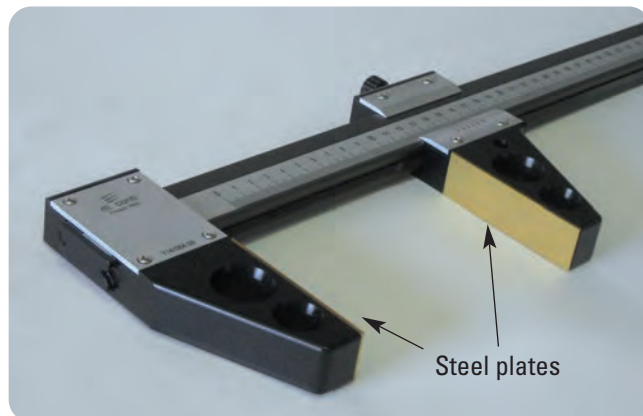

Suitable for measuring the width and length of glass and aluminium items and when cutting sheet metal.

JAW LENGTH 97 mm.

Plates in TIN coated high resistance steel.

Item	Measuring range
C.LIN.L.PA0500	0÷500
C.LIN.L.PA0750	0÷750
C.LIN.L.PA1000	0÷1000
C.LIN.L.PA1500	0÷1500
C.LIN.L.PA2000	0÷2000
C.LIN.L.PA2500	0÷2500
C.LIN.L.PA3200	0÷3200

GAUGE FOR 45° CUTS

ART. C.L45



Suitable for the production of frames, sashes and other components with 45° angles.
Minimum measurable length - 80mm.



Item	Measuring range
C.L45.0500	80÷500
C.L45.0750	80÷750
C.L45.1000	80÷1000
C.L45.1500	80÷1500
C.L45.2000	80÷2000
C.L45.2500	80÷2500
C.L45.3200	80÷3200

GAUGE FOR DIAGONAL AND OUT OF SQUARE MEASUREMENTS

ART. C.LIN.D

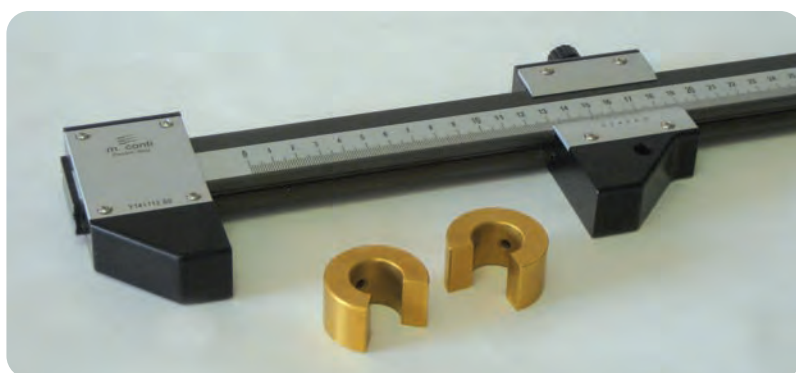

Suitable for measuring the out of square of a panel or any diagonal line



2 reference steel discs included

Item	Measuring range
C.LIN.D.0500	0÷500
C.LIN.D.0750	0÷750
C.LIN.D.1000	0÷1000
C.LIN.D.1500	0÷1500
C.LIN.D.2000	0÷2000
C.LIN.D.2500	0÷2500
C.LIN.D.3200	0÷3200

Spare parts

C.DIS.040	D=40 - 90° cut - Reference steel disc
-----------	---------------------------------------

OPTICAL LENS

ART. C.LETTORE

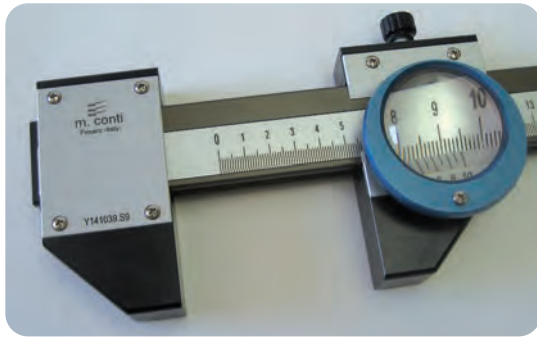

Magnifying glass used to improve the evaluation of the scale in case of reading from a distance.
Made of anodized aluminium dia. 50 mm, it can be used with any gauge.

Item	Dimensions
C.LETTORE	Ø 50

CALIBRATION CERTIFICATE

ART. CERT.



On request, all gauges can be supplied with our calibration certificate which certifies the accuracy every 100 mm.
The gauges are tested using certified gauge blocks.

Item	Gauge measuring range
CERT.0500	500
CERT.0750	750
CERT.1000	1000
CERT.1500	1500
CERT.2000	2000
CERT.2500	2500
CERT.3200	3200

GAUGES DIGIT +

The **Digit +** digital gauges have been designed and developed to meet the need to take as quickly as possible the measurements of the dimensions of the panels in the production units.

Thanks to digital technology and to the large and easy to use display, the subjectivity of the operator is bypassed and the maximum precision is ensured.

All **Digit +** can be supplied on request with centesimal resolution (0.01 mm) and / or serial output.

GAUGES FOR LINEAR MEASUREMENTS

ART. DIGIT950



- Resolution 0,1 mm
- Light, precise and easy to use
- Battery powered (1 battery 1,5 V type AA)
- Measuring system by magnetic strip our production
- Display functions:
 - absolute/relative
 - selection of measuring mode
 - programmable automatic shutdown
 - mm/inches conversion
 - large display for easy reading
- Bars and jaws are made of anodized aluminium with 500 HV hardness on the surface

Item	Measuring range
DIGIT950.0500	0÷500
DIGIT950.0750	0÷750
DIGIT950.1000	0÷1000
DIGIT950.1500	0÷1500
DIGIT950.2000	0÷2000
DIGIT950.2500	0÷2500
DIGIT950.3100	0÷3100

GAUGES FOR LINEAR-INSIDE/OUTSIDE MEASUREMENTS

ART. DIGIT955

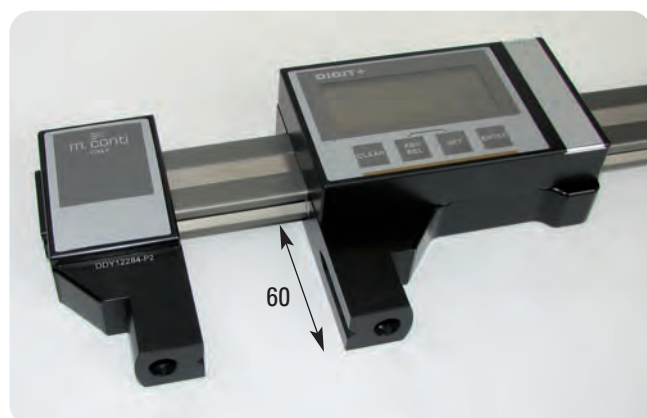

- Resolution 0,1 mm
- Light, precise and easy to use
- Battery powered (1 battery 1,5 V type AA)
- Measuring system by magnetic strip our production
- Display functions:
 - absolute/relative
 - selection of measuring mode
 - programmable automatic shutdown
 - mm/inches conversion
 - large display for easy reading
- Bars and jaws are made of anodized aluminium with 500 HV hardness on the surface

Optional kit: two pins (Ø4-15) for measuring distance between holes + reference jig for measuring distance between hole and edge of the panel.

Item	Measuring range
DIGIT955.0500	0÷500
DIGIT955.0750	0÷750
DIGIT955.1000	0÷1000
DIGIT955.1500	0÷1500
DIGIT955.2000	0÷2000
DIGIT955.2500	0÷2500
DIGIT955.3100	0÷3100

GAUGE FOR LINEAR, INSIDE/OUTSIDE, DISTANCE BETWEEN HOLES, OUT OF SQUARE ANGLES MEASUREMENTS

ART. DIGIT990



- Resolution 0,1 mm
- Light, precise and easy to use
- Battery powered (1 battery 1,5 V type AA)
- Measuring system by magnetic strip our production
- Display functions:
 - absolute/relative
 - selection of measuring mode
 - programmable automatic shutdown
 - mm/inches conversion
 - large display for easy reading
- Bars and jaws are made of anodized aluminium with 500 HV hardness on the surface

Complete with no° two pins (Ø4-15) for measuring distance between holes + reference jig for measuring distance between hole and edge of the panel.

Item	Measuring range
DIGIT990.0500	0÷500
DIGIT990.0750	0÷750
DIGIT990.1000	0÷1000
DIGIT990.1500	0÷1500
DIGIT990.2000	0÷2000
DIGIT990.2500	0÷2500
DIGIT990.3100	0÷3100

Spare parts

C.PER.1415 Conical pin for dia. 4 ÷ 15 holes



GAUGE FOR 45° CUTS

ART. DIGIT991



- Resolution 0,1 mm
- Light, precise and easy to use
- Battery powered (1 battery 1,5 V type AA)
- Measuring system by magnetic strip our production
- Display functions:
 - absolute/relative
 - selection of measuring mode
 - programmable automatic shutdown
 - mm/inches conversion
 - large display for easy reading
- Bars and jaws are made of anodized aluminium with 500 HV hardness on the surface

Suitable for the production of frames, sashes and other components with 45° angles.
Minimum measurable length - 80mm.

Item	Measuring range
DIGIT991.0750	0÷750
DIGIT991.1000	0÷1000
DIGIT991.1500	0÷1500
DIGIT991.2000	0÷2000
DIGIT991.2500	0÷2500
DIGIT991.3100	0÷3100

**GAUGE FOR LINEAR, INSIDE/OUTSIDE, DISTANCE BETWEEN HOLES, OUT OF SQUARE ANGLES MEASUREMENTS
DIGIT992**



- Resolution 0,1 mm
- Light, precise and easy to use
- Battery powered (1 battery 1,5 V type AA)
- Measuring system by magnetic strip our production
- Display functions:
 - absolute/relative
 - selection of measuring mode
 - programmable automatic shutdown
 - mm/inches conversion
 - large display for easy reading



2 reference steel discs included

Item	Measuring range
DIGIT992.1000	0÷1000
DIGIT992.1500	0÷1500
DIGIT992.2000	0÷2000
DIGIT992.2500	0÷2500
DIGIT992.3100	0÷3100

Spare parts

C.DIS.040	D=40 - 90° cut - Reference steel disc (included)
C.PER.1415	Conical pin for dia. 4 ÷ 15 holes (not included)



VISIT OUR WEBSITE
www.sistemiklein.com



GAUGE FOR LINEAR MEASUREMENTS WITH LONG JAWS AND STEEL PLATES

ART. DIGIT980/985/986/987

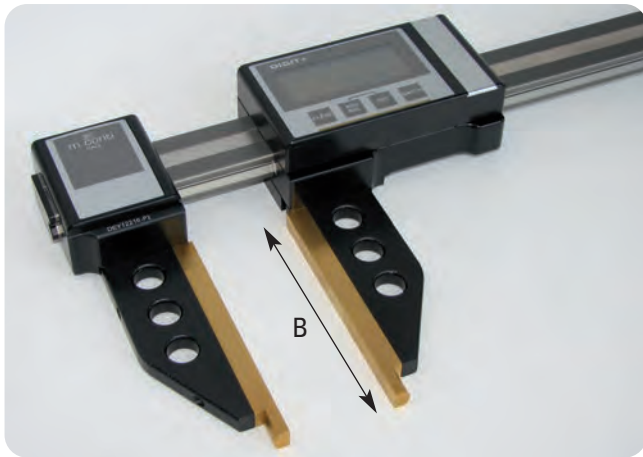

- Resolution 0,1 mm
- Light-weight but at the same time rigid and accurate
- Battery-powered (nr. 1 Battery 1,5 type AA)
- Measuring system by magnetic strip our production
- Main display features: absolute/relative measuring, selection of measuring mode, programmable automatic shutdown, mm/inch conversion, large numbers display for easy reading.

- **STEEL PLATES**
- **JAWS WITH LIGHTENING HOLES**

Item	Measuring range	B	Item	Measuring range	B
DIGIT980.1000	0÷1000	100	DIGIT986.1000	0÷1000	200
DIGIT980.1500	0÷1500	100	DIGIT986.1500	0÷1500	200
DIGIT980.2000	0÷2000	100	DIGIT986.2000	0÷2000	200
DIGIT980.2500	0÷2500	100	DIGIT986.2500	0÷2500	200
DIGIT980.3100	0÷3100	100	DIGIT986.3100	0÷3100	200
DIGIT985.1000	0÷1000	150	DIGIT987.1000	0÷1000	300
DIGIT985.1500	0÷1500	150	DIGIT987.1500	0÷1500	300
DIGIT985.2000	0÷2000	150	DIGIT987.2000	0÷2000	300
DIGIT985.2500	0÷2500	150	DIGIT987.2500	0÷2500	300
DIGIT985.3100	0÷3100	150	DIGIT987.3100	0÷3100	300

GAUGE WITH NONIUS FOR LINEAR-INSIDE/OUTSIDE MEASUREMENTS WITH LONG JAWS AND STEEL PLATES

ART. C.LIE.L.PA

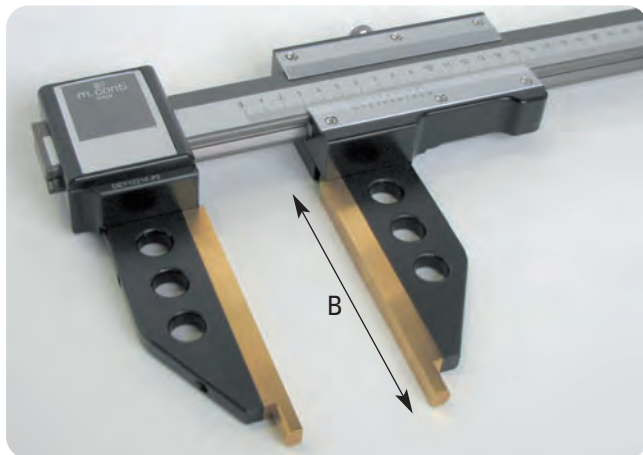

- Resolution 0,1 mm
- Light, precise and easy to use
- Suitable for measuring glass , aluminum, metal or PVC items
- Also fit for measuring parts in the metalworking industry

- **STEEL PLATES**
- **JAWS WITH LIGHTENING HOLES**

Item	Measuring range	B	Item	Measuring range	B
C.LIE.L.PA.1000.100	0÷1000	100	C.LIE.L.PA.1000.200	0÷1000	200
C.LIE.L.PA.1500.100	0÷1500	100	C.LIE.L.PA.1500.200	0÷1500	200
C.LIE.L.PA.2000.100	0÷2000	100	C.LIE.L.PA.2000.200	0÷2000	200
C.LIE.L.PA.2500.100	0÷2500	100	C.LIE.L.PA.2500.200	0÷2500	200
C.LIE.L.PA.3100.100	0÷3100	100	C.LIE.L.PA.3100.200	0÷3100	200
C.LIE.L.PA.1000.150	0÷1000	150	C.LIE.L.PA.1000.300	0÷1000	300
C.LIE.L.PA.1500.150	0÷1500	150	C.LIE.L.PA.1500.300	0÷1500	300
C.LIE.L.PA.2000.150	0÷2000	150	C.LIE.L.PA.2000.300	0÷2000	300
C.LIE.L.PA.2500.150	0÷2500	150	C.LIE.L.PA.2500.300	0÷2500	300
C.LIE.L.PA.3100.150	0÷3100	150	C.LIE.L.PA.3100.300	0÷3100	300

GAUGE WITH WIRELESS CONNECTION FOR LINEAR MEASUREMENTS

ART. DIGIT950



The DIGIT+ RF have a sender integrated in the caliper and a separate Master for receiving the data appearing on the display of the digital caliper and sent via **radio frequency**.

The Receiver must be connected to a Computer or any device able to process an ASCII string via RS232. In open space the transmission distance is apprx. **50 meters**.

Item	Measuring range
DIGIT950.1000RF	0÷1000
DIGIT950.1500RF	0÷1500
DIGIT950.2000RF	0÷2000
DIGIT950.2500RF	0÷2500
DIGIT950.3100RF	0÷3100

GAUGE WITH WIRELESS CONNECTION FOR LINEAR, INSIDE/OUTSIDE, DISTANCE BETWEEN HOLES, OUT OF SQUARE ANGLES MEASUREMENTS

ART. DIGIT990



The DIGIT+ RF have a sender integrated in the caliper and a separate Master for receiving the data appearing on the display of the digital caliper and sent via **radio frequency**.

The Receiver must be connected to a Computer or any device able to process an ASCII string via RS232. In open space the transmission distance is apprx. **50 meters**.

Item	Measuring range
DIGIT990.1000RF	0÷1000
DIGIT990.1500RF	0÷1500
DIGIT990.2000RF	0÷2000
DIGIT990.2500RF	0÷2500
DIGIT990.3100RF	0÷3100

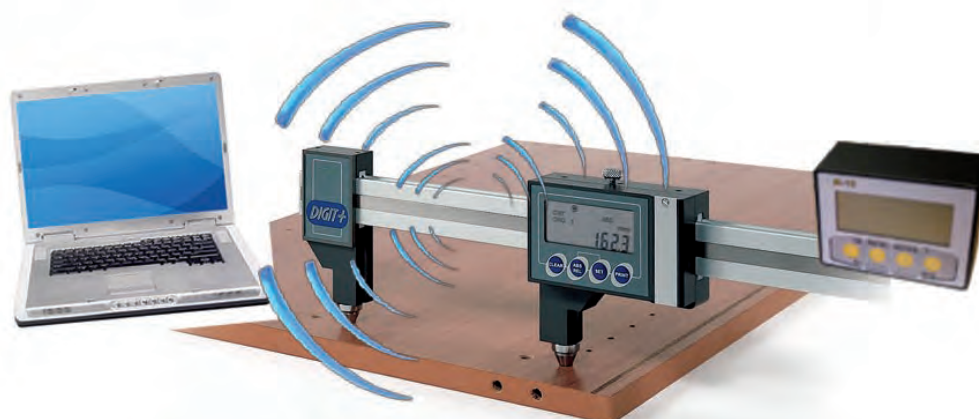

MAGNETIC STRIP MEASURING SYSTEM

A fast and accurate system which allows reading of measurements directly on the M10 display. It is extremely easy to apply – just fix the magnetic strip on a suitable surface of the machine with double-sided adhesive tape and fit the display with the sensor on the movable part. When movement is made, the display indicates the position with respect to a machine reference. The measuring system can be used on PANEL SIZING MACHINES, ROLLER BEDS FOR MITRE SAWS, BORING MACHINES, CIRCULAR SAWS etc.



Item	Dimension
K.M.1000	Magnetic strip length 1000 mm
K.M.1500	Magnetic strip length 1500 mm
K.M.2000	Magnetic strip length 2000 mm
K.M.3000	Magnetic strip length 3000 mm
K.M.4500	Magnetic strip length 4500 mm

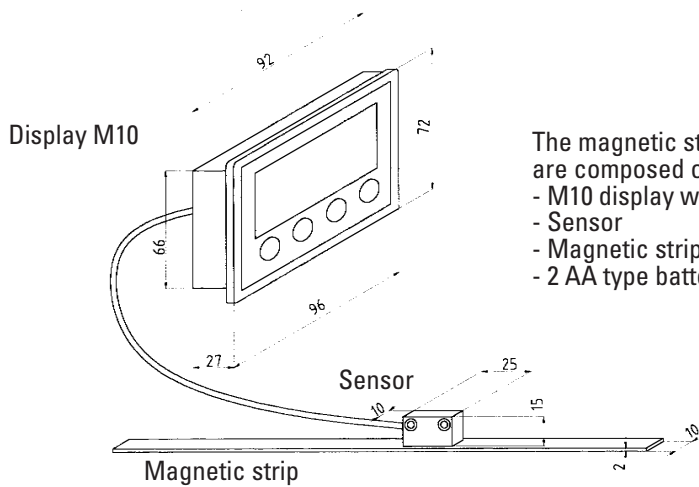

The magnetic strip measuring system is supplied in kits, they are composed of:

- M10 display with 0.5 m cable
- Sensor
- Magnetic strip (with double-sided tape)
- 2 AA type batteries



Application on panel sizing machines for squaring cuts

MAIN CHARACTERISTICS

- M10 display dimensions: 96x72x27 mm
- battery-powered with 1.5V AA type battery with a 12-month life
- system accuracy: 0.1 mm
- 5 incremental counting
- 5 programmable offsets
- programmable zero point
- battery check
- self diagnostic in real-time
- wide installation tolerances
- parameters stored in permanent memory
- battery voltage control shown on the display
- multifunction LCD display
- 4-key display keypad
- operating temperature: 5° - 60°C
- storage temperature: -20° - 70°C
- max. humidity: 95% (condensation not permitted)
- magnetic strip: 10x2 mm
- type of magnetic strip: MT500
- distance between magnetic strip and sensor: max. 2.5 mm

ELECTRONIC WORK STATION

For modern panel production for the furniture industry, adequate quality control is indispensable. During the production, to set up the manufacturing machines, at the end of the work shift for quality control, on acceptance of semi-finished products from third parties and for product certification, the electronic work station ensures the quality of your products and cuts machine stops and the time taken for assembly, thereby increasing productivity.



Item	Description
BCE 25 Y10-R	dimensions 2.500 mm x 1.000 mm - panel thickness 55 mm - precision 0,1 mm with 6-position revolver



Execution with 6-position revolver to speed up feeler pin change

THANKS TO THIS WORK STATION YOU CAN CHECK

- Panel dimensions
- Out of square angles
- Distances between hole centres
- Parallelism and orthogonality between holes
- Depth of vertical and horizontal holes
- Dimension of grooves on panels
- Profiles on shaped panels
- Possibility of zero-setting to left and right



WATCH VIDEO



Blocking system by means of 2 vacuum units
Useful when small panels are measured (optional)

The electronic workstation is a real "quality control station" able to check almost all dimensions on the length, width and thickness of the panel. **The tolerance of max. 0,1mm** mistake on the whole device surface is guaranteed. **First quality components** as well as highly automated processing cycle ensure the extreme precision of the workstation. Last production step consists in the complete and **scrupulous inspection effected** also using certified block gauges. The electronic workstation can also operate in dusty environment.

SOFTWARE (optional)

For a rational use of the electronic workstation , a special software program has been developed to suit the requirements of modern furniture production and semi-finished products.

Completely worked out at **M.Conti** in collaboration with expert computer engineers and advise from important manufacturing companies, the software has been developed considering and trying to solve all producers' requirements.

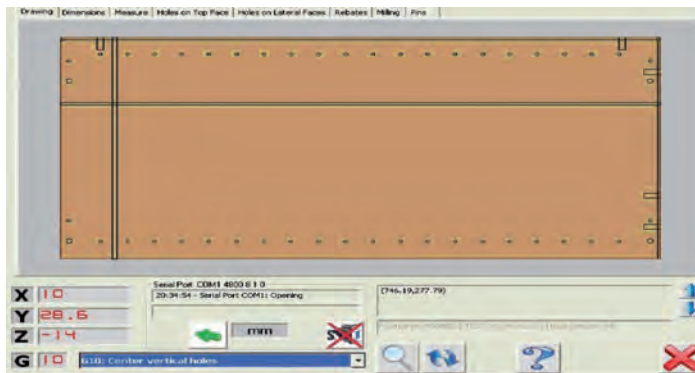
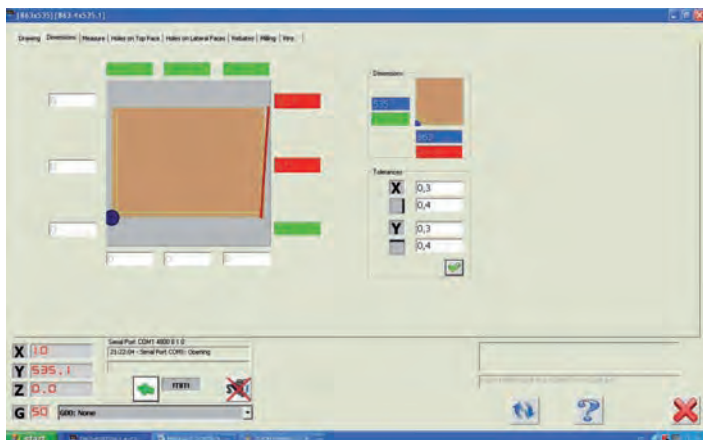

SOFTWARE SPECIFICATION

1) To **check and compare** a finished piece, or a CAD execution of the piece.

The elements which can be measured are:

1. Panel squaring
2. Vertical holes
3. Horizontal holes
4. Cuts
5. Relative distances

Using the software program we can visualize the measuring taken on the display and compare them with those requested thus detecting any mistake in production or out of tolerance dimension

A final report showing the measures taken can be printed, stored or attached to the production batch.

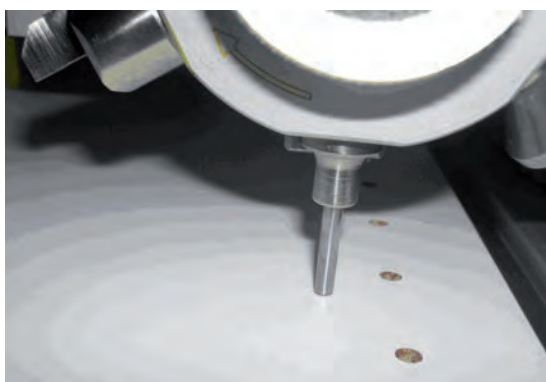
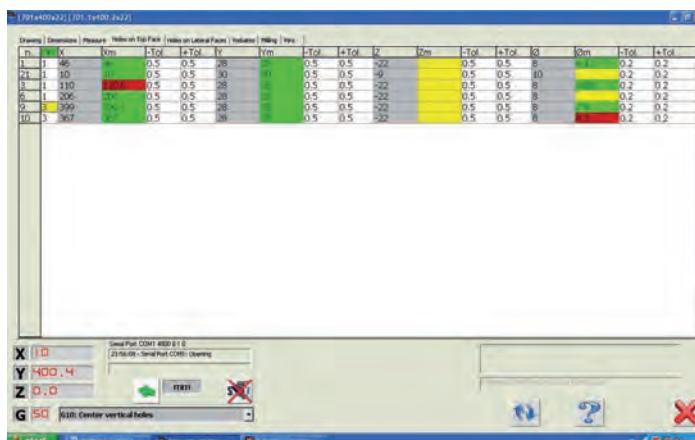

2) Graphic mode:

To **digitise a sample piece** and create a DXF file.

Necessary if you need to check the dimensions of a sample curves panel and save them in a DXF file in order to modify it with every CAD program

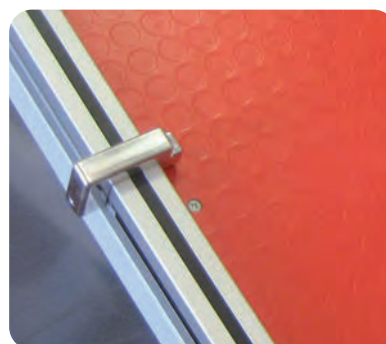

Side stop, longer execution (optional)



OPTIONAL FEATURES

Item	Description
AS1500201	software program
SPP040077	Z-axis
SPP040079	panel hold down system
SPP040107	additional vacuum unit
SPP040080	6 adapters revolver
AS1500224	higher side stop

SPECIAL DEVICES



“ARKADE+ZINKEL+ELLIX”
Page 16.03



TRIMATIC FOR HINGES
Page 16.04 - 16.05



TRIMATIC 32
Page 16.06



DRILLING JIG FOR CREMONE BOLTS
Page 16.07



SPECIAL DEVICES FOR ANGULAR
HINGES INSERTING
Page 16.08



TRIMATIC 22.4 FOR “LAMELLO® CABINEO®”
Page 16.09



DRILLING JIG FOR MAKING HOLES
FOR HINGE INSERTING
Page 16.10 - 16.11



DRILLING OF WOOD AND PVC WINDOW
FRAME TO FIT CREMONE BOLT
Page 16.11



TRIMATIC SUPER 22.4 FOR “LAMELLO®
CABINEO®”
Page 16.12



DRILLING JIG FOR MAKING HOLES
FOR HINGE INSERTING - 32/90°
Page 16.12



ECCENTRIC CLAMP
Page 16.13



DRIVER FOR CURVES
Page 16.13



LIFTING CLAMP
Page 16.13



EDGE CLAMP
Page 16.14



CARPENTER'S CLAMP
Page 16.14



DOOR LIFTER
Page 16.14





**HORIZONTAL TYPE WITH
HORIZONTAL CLAMPING**
Page 16.15



**HORIZONTAL TYPE WITH
VERTICAL CLAMPING**
Page 16.15



PNEUMATIC TYPE
Page 16.15



PUSHER TYPE
Page 16.15



SPARE ENDPINS
Page 16.15



KLEIN WASHER
Page 16.16



KLEIN CLEANER
Page 16.16



SHRINK FIT UNIT
Page 16.16



COOLING UNIT WITH AIR FLOW
Page 16.16



**ANGLE HEADS FOR
CNC ROUTING MACHINES**
Page 16.17 - 16.19

"ARKADE+ZINKEL+ELLIX" - The complete routing system for arches

The building techniques of the ancient Greeks and Egyptians had not contemplated the joining of wall openings by the use of arches. Roman times brought great technological progress. Thanks to archlinking they were able to create wider openings and so this technique became increasingly popular. The greatest development and the most gracious examples of arch construction came during the middle ages and continued through the years until more modern times when other building methods largely replaced the use of arches. Modern day building construction has rediscovered the charm, aesthetic taste and practical aspects of archlinking and because of this our technical department has developed and patented "ARKADE + ZINKEL". This is the only equipment on the market today capable of drawing and producing wooden, double-radius arch frames with practically no size restriction, quickly and with unmatched quality results.

"ARKADE" equipment can produce round and/or flat arches with minimum diameter 27 cm and maximum diameter 6m. If the "ARKADE" is complemented by "ZINKEL" equipment, it is also possible to make double-radius arches with a smaller radius between 13.5 and 80 cm and a larger radius of 3 m; and with particular accessories, even greater dimensions can be achieved. With "ELLIX" and some parts from "ARKADE" a perfect geometrical ellipses can be obtained.

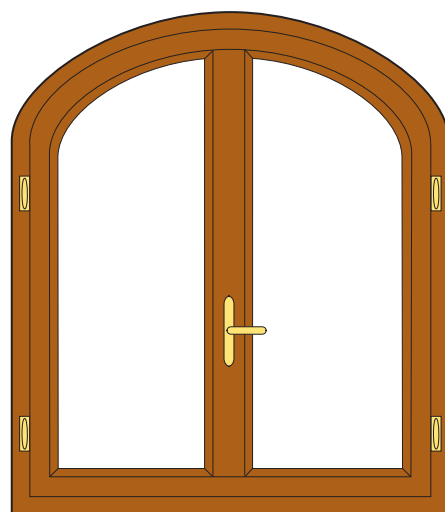

PATENT nr. AN93A000054



Item

ARKADE
"ARKADE" complete with tracer unit and goniometer



Item

ZINKEL
"ZINKEL" articulate accessory for double-radii arches



Item

ELLIX
"ELLIX" the equipment for perfect geometrical ellipse for customers already using "ARKADE"



Item

ELLISISTEM
"ELLISISTEM" is the "last born" of our special equipments for producing arch frames. With "ELLISISTEM" the customer can execute a perfect geometrical ellipse. Suitable for house restoration where the double radius arch is difficult to fit. Simple and easy to use, it keeps the same work procedure and features as "ARKADE" + "ELLIX"

Watch the Video on
YouTube



Examples of windows made with "Arkade+Zinkel+Ellix"



TRIMATIC FOR HINGES

TRIMATIC are drilling jigs which allow making holes required in a single pass using a normal pillar drill or a portable electric drill. These articles are dedicated to craftsmen and hobbyists who have drilling problems when fitting hinges or positioning shelves with holes at a distance between centres of 32 mm.

The **TRIMATIC** unit with three tool-holders is suitable to make the three holes to fix the hinge in a single pass with distance between centres depending on the hinge to be fixed. Tools diameter depends on the hinge used. The central bit must have right hand rotation, the lateral bits have left hand rotation.

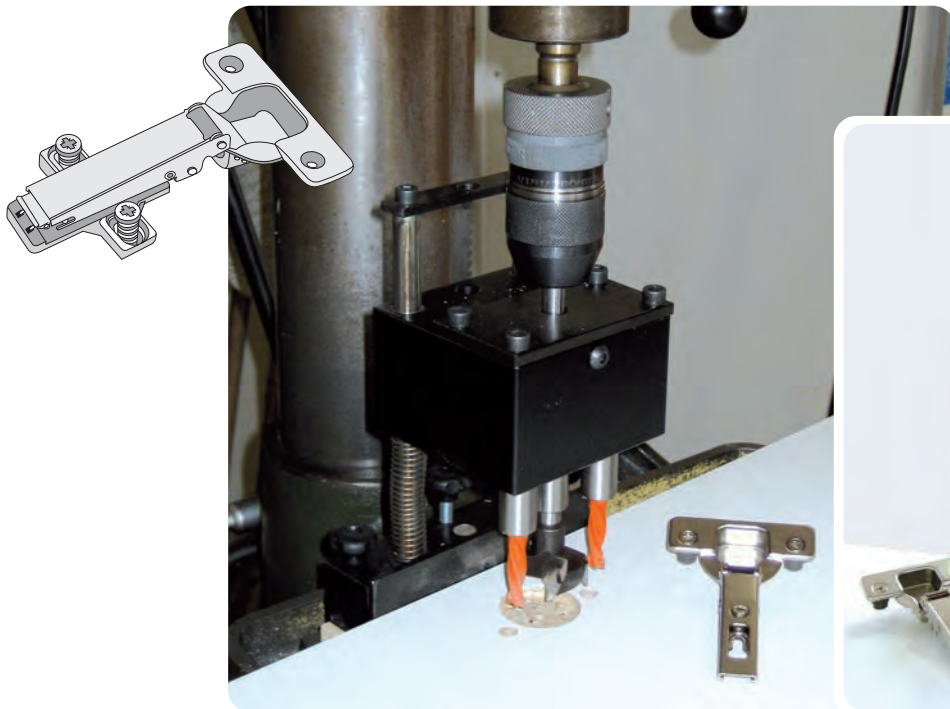

TRIMATIC 48/6 used with a pillar drilling machine



TRIMATIC 48/6 used with a portable drilling machine



Item	
TRIMATIC 38/7,5	Mini-hinges

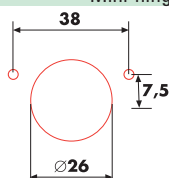

TRIMATIC 42/11	for hinges type "Grass"
----------------	-------------------------

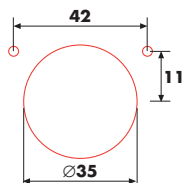

TRIMATIC 45/9,5	for hinges type "Blum"
-----------------	------------------------

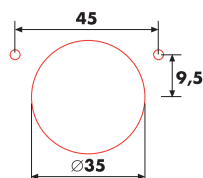

TRIMATIC 48/6	for hinges type "Salice"
---------------	--------------------------

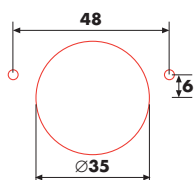

Item	
TRIMATIC 48/9	for hinges type "Mepla"

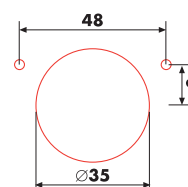

TRIMATIC 52/5,5	for hinges type "Hettich"
-----------------	---------------------------

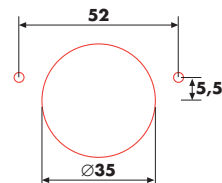

TRIMATIC 52/9	for hinges type "Hafele"
---------------	--------------------------

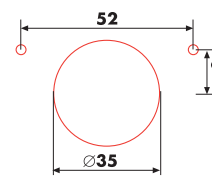

TRIMATIC 52/7,5	hinges for large thickness
-----------------	----------------------------

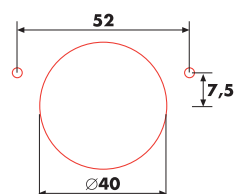

Designed in 1998 is one of the most innovative products in the woodworking field. Tested and appreciated by the most important hinges manufacturers, only our TRIMATIC boring jigs allow making more than **50.000** bores.

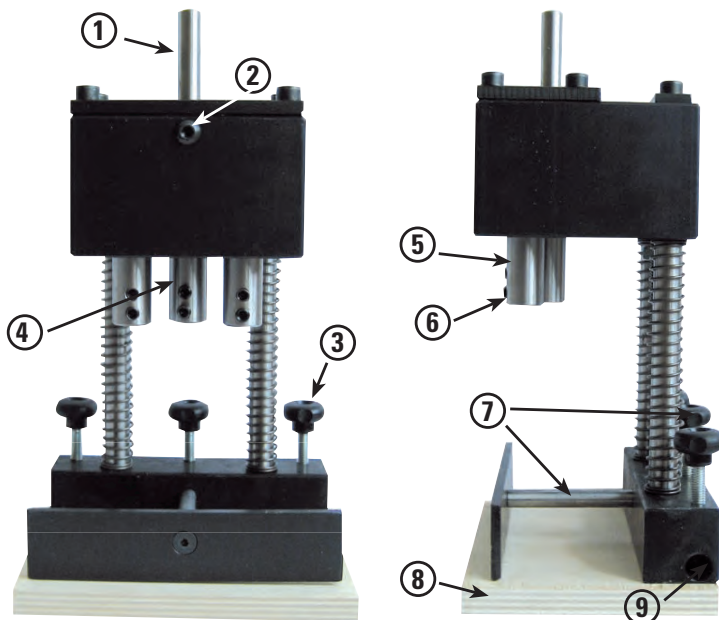

DESCRIPTION

- 1) Arbor for pillar drill spindle
- 2) Threaded hole for greasing
- 3) Locking knob for stop reference rod
- 4) Distance adjusting screw "B"
- 5) Tool holder bush
- 6) Tool locking screw
- 7) Distance adjusting screw "A"
- 8) Equipment support table
- 9) Stop rod sliding hole

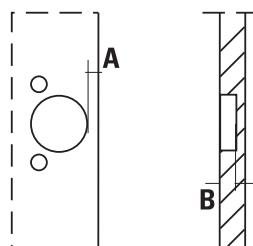

HW tools suitable for TRIMATIC

∅	Description	Rotation
3	L120.030.L + Z011.030.N	Lh
5	L103.050.L	Lh
8	L103.080.L	Lh
10	L103.100.L	Lh
26	L140.260.R	Rh
35	L140.350.R	Rh
40	L140.400.R	Rh

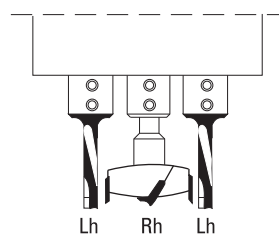

The central bit must have right hand rotation, the lateral bits have left hand rotation

DIMENSIONS

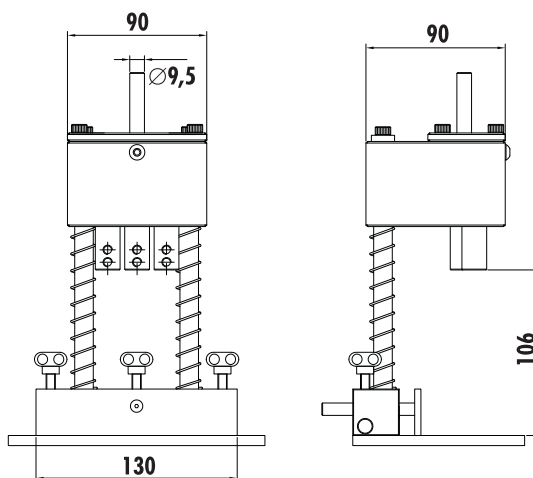

TRIMATIC 32

The **TRIMATIC** unit with five tool holders is suitable to make a five holes set with distance between centres of 32 mm in a single pass. This device is designed for drilling holes in lateral panels (sides) of furniture for both fixing the hinge and positioning the shelves at the height desired. In the **TRIMATIC 32** the tool diameters depend on the fittings used. The central bit and those mounted in the external positions have right hand rotation, the other tools have left hand rotation.

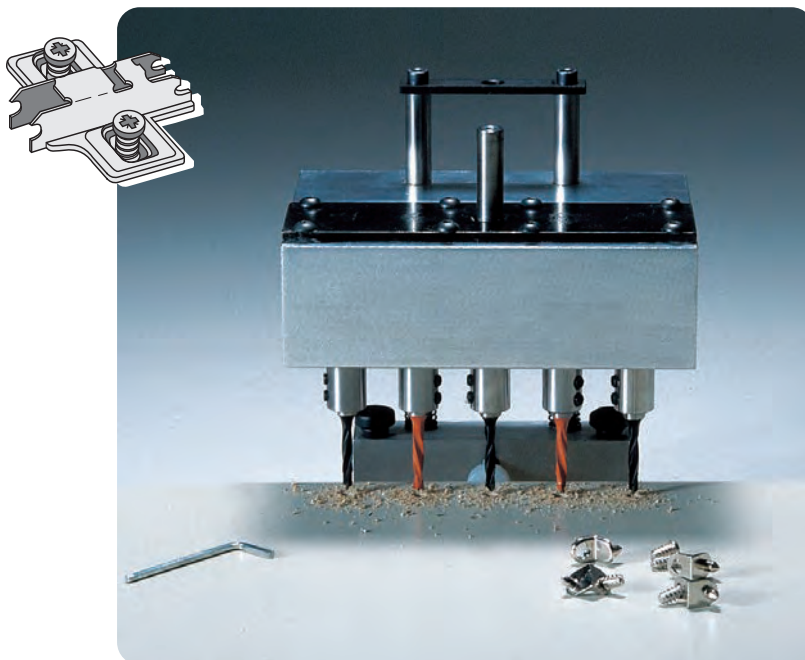

Item
TRIMATIC 32

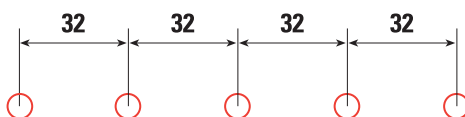

HW tools suitable for TRIMATIC 32

Ø	Description	Rotation
4	L103.040.R	Rh
4	L103.040.L	Lh
5	L103.050.R	Rh
5	L103.050.L	Lh

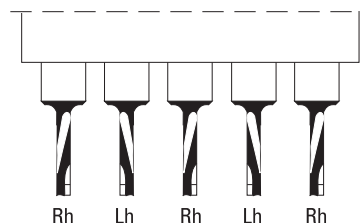

DIMENSIONS



The central bit and those mounted in the external positions have right hand rotation, the other tools have left hand rotation.

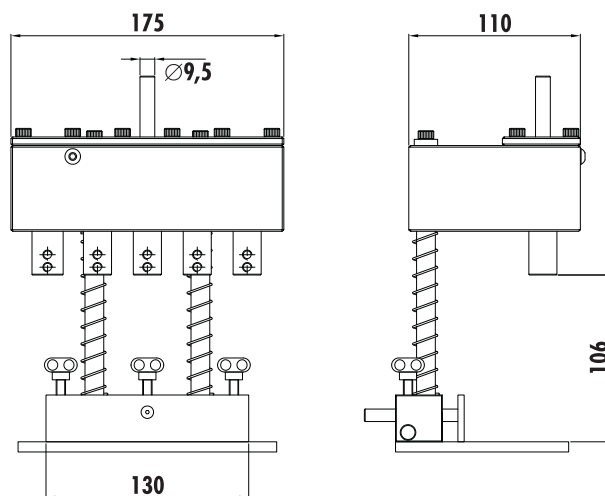

DRILLING JIG FOR CREMONE BOLTS

TRIMATIC 43/0 was designed for window frame makers who have problems with drilling holes to fit the handle on wood, wood/aluminium and PVC windows. **TRIMATIC 43/0** allows drilling the three holes necessary to fit the cremone bolt in one single pass with a normal pillar drill or a portable electric drill.

TRIMATIC 43/0, a drilling jig for handles with a distance between centres of the retaining screws of 43 mm.

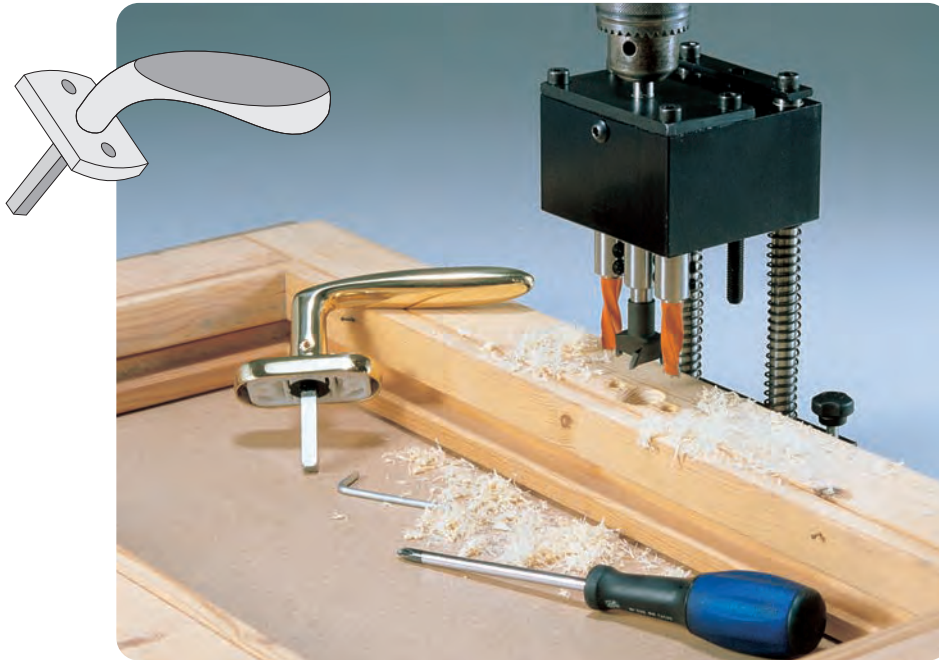

Drilling of wood and PVC window frames to fit cremone bolts

Item
TRIMATIC 43/0

HW tools suitable for TRIMATIC 43/0

Ø	Description	Rotation
4	L103.040.R	Rh
4	L103.040.L	Lh
5	L103.050.R	Rh
5	L103.050.L	Lh
8	L103.080.L	Lh
10	L103.100.R	Rh
10	L103.100.L	Lh
12	L103.120.R	Rh
12	L103.120.L	Lh
25	L140.250.R	Rh
26	L140.260.R	Rh

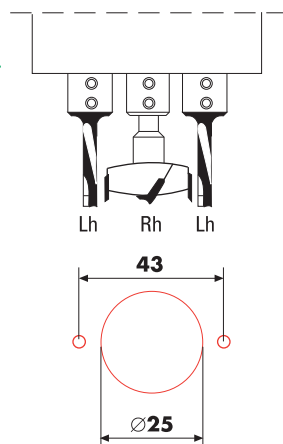

HSS tools suitable for TRIMATIC 43/0 for working PVC and Aluminium

Ø	Description	Rotation
8	U260.080.L	Lh
10	U260.100.L	Lh
12	U260.120.R	Rh
12	U260.120.L	Lh
14	U260.140.R	Rh

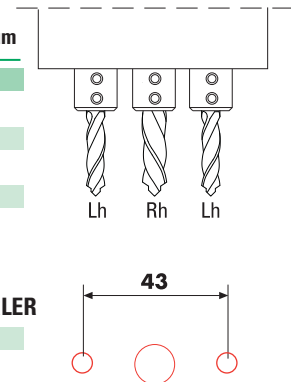

Some examples of drilling patterns

SIEGENIA-TRIAL		WEIDTMANN-KURLER	
U260.120.L	2	U260.100.L	2
U260.120.R	1	U260.140.R	1
G-U JET77		OLIVEN	
U260.100.L	2	U260.080.L	2
U260.120.R	1	U260.140.R	1



The central bit must have right hand rotation, the lateral bits have left hand rotation.

DIMENSIONS

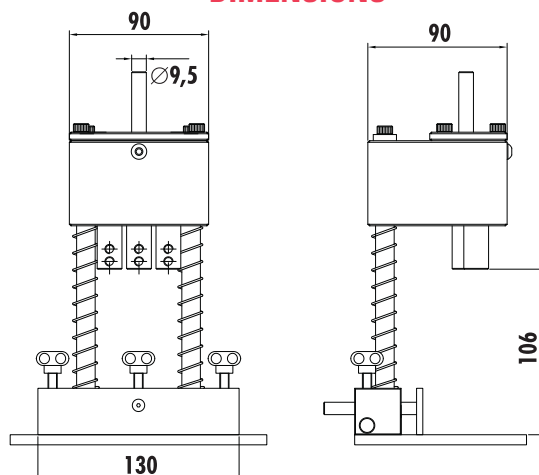

SPECIAL DEVICES FOR ANGULAR HINGES INSERTING

With constant attention paid to our customers' requirements and ongoing research for developing new technical solutions for helping craftsmen and small firms, our special equipments **TRIMATIC 22, 25 e 28** help the window makers to make holes for angular hinges to be mounted on windows and door-windows, in wood and wood-aluminium material. The **TRIMATIC 22, 25 e 28** can be used either with pillar drills or portable electric drills, and have distance between holes suitable for angular hinges of the following types: Siegenia (Trimatic 22), GU (Trimatic 25), Maico and AGB (Trimatic 28).



Fixing of edge hinge



Fixing of top hinge



Item

TRIMATIC 22 for angular hinges "SIEGENIA" (Ø30 and Ø34) with a distance between holes of 22 mm

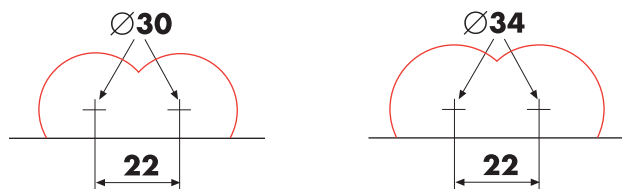

TRIMATIC 25 for angular hinges "GU" with a distance between holes of 25 mm

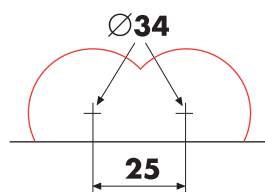

TRIMATIC 28 for angular hinges MAICO (type "Trend") and AGB with a distance between holes of 28 mm

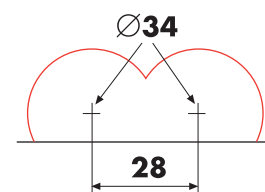

Mount the right-hand rotation bit on the bush related to the drill spindle and the left-hand rotation bit on the other bush.

DIMENSIONS

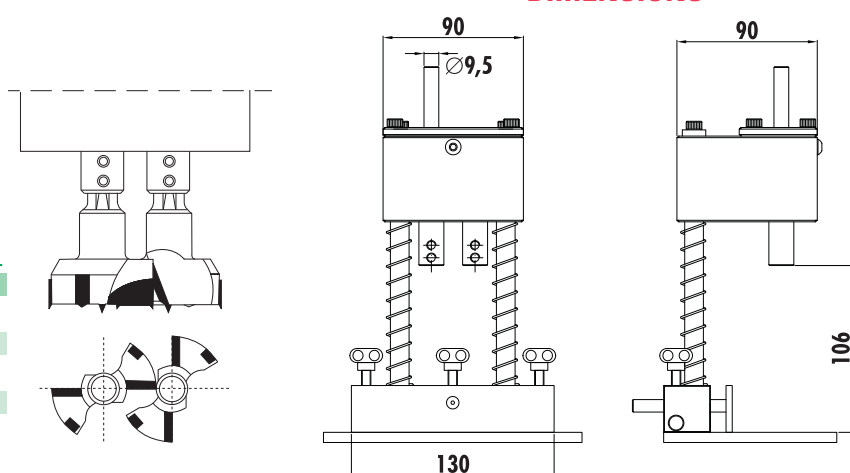

HW tools suitable for TRIMATIC 22 - 25 - 28

Ø	Description	Rotation
30	L160.300.R	Rh
30	L160.300.L	Lh
34	L160.340.R	Rh
34	L160.340.L	Lh

TRIMATIC 22,4 FOR "LAMELLO® CABINEO®"

SISTEMI has always paid special attention to the demands of woodworkers and their issues in the woodworking. For this reason, we have developed Trimatic 22,4: the new and only drilling jig on the market that can drill the required three blind holes for mounting **Lamello® Cabineo®** furniture connection, in a single pass simply using a power portable drill or stationary pillar drill. It is especially thought for hobbyists, artisans and craftsmen who do not own CNC router machines.

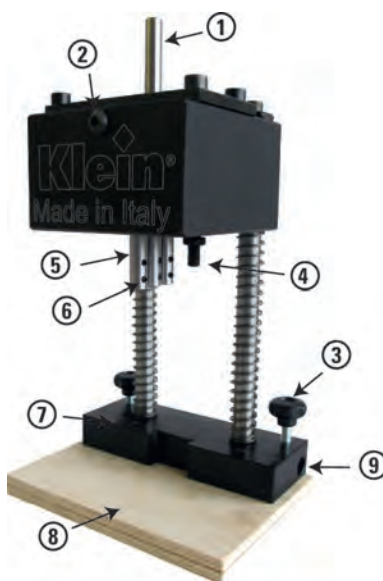

- 1) Arbor for pillar drill spindle
- 2) Threaded hole for greasing
- 3) Locking knob for stop reference rod
- 4) Threaded screw for depth adjustment
- 5) Tool holder bush
- 6) Tool locking screw
- 7) Basement with millimetric scale
- 8) Equipment support table
- 9) Stop rod sliding hole

The special millimetric scale on the basement will help you to make the 5 mm hole in the corresponding workpiece to tighten the screw of Cabineo® with accuracy



Item
TRIMATIC 22,4

TOOLING (not included)

A) Equip Trimatic 22,4 with HW drill bits (item L174.150.R e L174.150.L) as per drawing (1) to make the three holes for inserting "Lamello® Cabineo®" connections.

S Ø 6	Description	Rotation
L174.150.R	Ø 15x35	Rh
L174.150.L	Ø 15x35	Lh



L174.150.R



L174.150.L (x2)

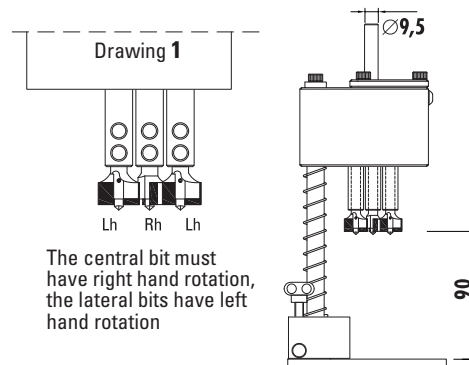
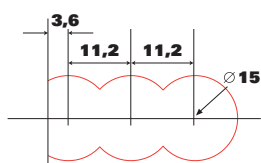

B) Equip Trimatic 22,4 (as per drawing 2) with one of the drill bits L175.050.L (for "Cabineo 8") or L175.051.L (for "Cabineo 12") to make ø 5 mm holes to fix Lamello® Cabineo® connections. The distance between this hole and the edge of the panel is achieved with an adjustment stop **C** (see drawing 2) whose thickness is determined by the thickness of the panel **D**, as per table (3) below.

S Ø 6	Description	Rotation
L175.050.L	Ø5x8x35 - "Cabineo 8"	Lh
L175.051.L	Ø5x12x39 - "Cabineo 12"	Lh



L175.050.L/L175.051.L



(3) Table to determine thickness of stop C in accordance with thickness of panel D

D= Panel thickness	C= Adjustment stop thickness
12 mm	19 mm
14 mm	17 mm
16 mm	15 mm
18 mm	13 mm (included)
20 mm	11 mm
22 mm	9 mm
24 mm	7 mm
25 mm	6 mm

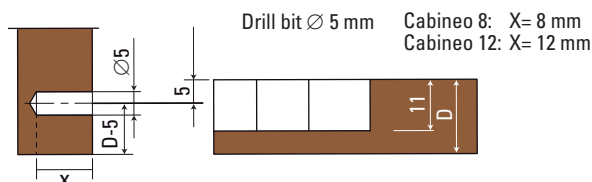
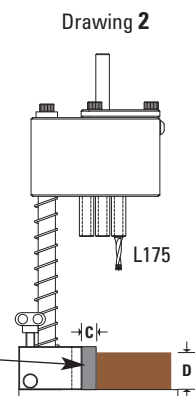

Cabineo® is a product of



DRILLING JIG FOR MAKING HOLES FOR HINGE INSERTING

The **TRIMATIC SUPER** is a very innovative drilling jig, suitable to solve many problems to craftsmen and small industries when fitting the hinges and handles on doors, windows and cabinet doors. The **TRIMATIC SUPER** can be easily and quickly mounted on the multi-spindles head of any automatic boring machine with 32 mm distance between centres chucks. The **TRIMATIC SUPER** is very precise and fast, making in one single pass the three holes required for fitting the hinges on the cabinet doors.

At the moment, 8 types **TRIMATIC SUPER** in different patterns are available, suitable for the most common hinges: Salice, Blum, Hettich, Grass, Mepla, Ferrari, ecc. The new model 43/0, is now available for the execution of the holes necessary to fit the cremone bolt on the handles of doors and windows. The **TRIMATIC SUPER** are small-sized, 12,5x5x3 cm, but they are very solid and long-lasting devices. The diameter of the drills has to be chosen with reference to the model of hinges being used. Now, just choose the type of **TRIMATIC SUPER** you need.

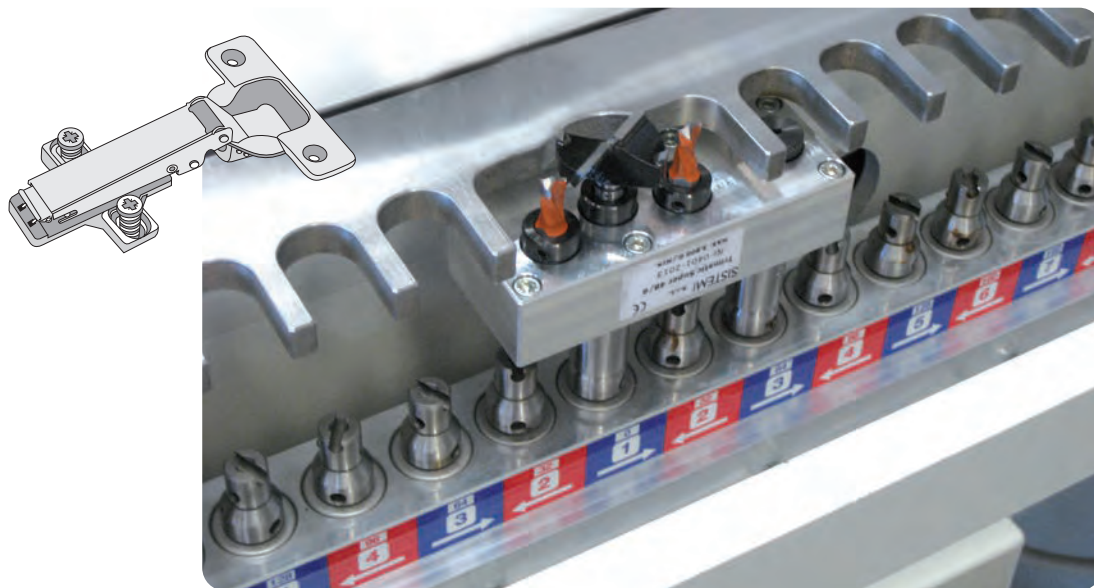

Item
TRIMATIC SUPER 38/7,5 Mini-hinges

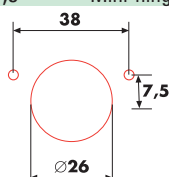

TRIMATIC SUPER 42/11 for hinges type "Grass"

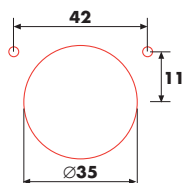

TRIMATIC SUPER 45/9,5 for hinges type "Blum"

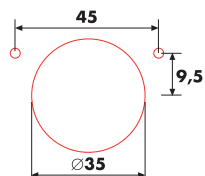

TRIMATIC SUPER 48/6 for hinges type "Salice"

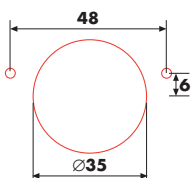

Item
TRIMATIC SUPER 48/9 for hinges type "Mepla"

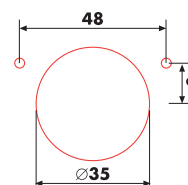

TRIMATIC SUPER 52/5,5 for hinges type "Hettich"

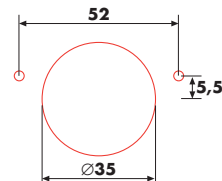

TRIMATIC SUPER 52/9 for hinges type "Hafele"

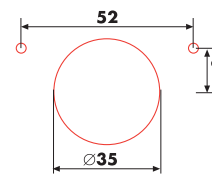

TRIMATIC SUPER 52/7,5 hinges for large thickness

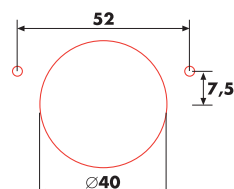

DRILLING JIG FOR MAKING HOLES FOR HINGE INSERTING



HW tools suitable for TRIMATIC SUPER

Ø	Description	Rotation
3	L120.030.L + Z011.030.N	Lh
5	L171.050.L	Lh
8	L171.080.L	Lh
10	L171.100.L	Lh
26	L170.260.R	Rh
35	L170.350.R	Rh
40	L170.400.R	Rh

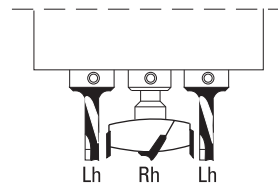

DIMENSIONS

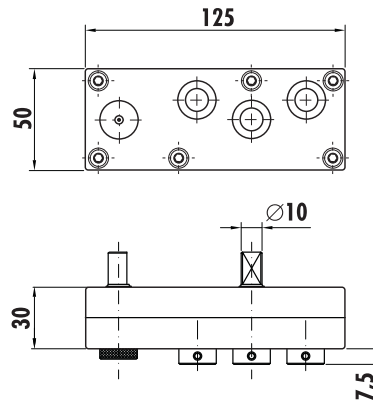

The central bit must have right hand rotation, the lateral bits have left hand rotation.

DRILLING OF WOOD AND PVC WINDOW FRAME TO FIT CREMONE BOLT

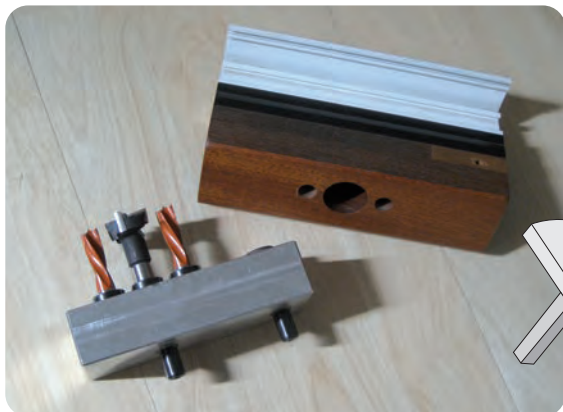

Item
TRIMATIC SUPER 43/0

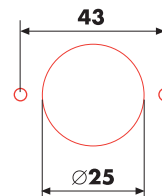

HW tools suitable for TRIMATIC SUPER 43/0

Ø	Description	Rotation
10	L103.100.L	Lh
12	L103.120.L	Lh
25	L140.250.R	Rh

TRIMATIC SUPER 22,4 FOR "LAMELLO® CABINEO®"

The new **TRIMATIC SUPER 22,4** allows to drill at the same time the three holes perpendicular to the machine boring axis suitable for mounting Cabineo® connections.



TRIMATIC SUPER 22,4 drilling jig for multi spindles machines

HW tools suitable for TRIMATIC SUPER 22,4

S Ø 6	Description	Rotation
L174.150.R	Ø 15x35	Rh
L174.150.L	Ø 15x35	Lh

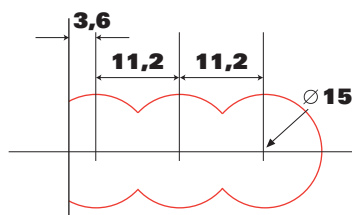

Item
TRIMATIC SUPER 22,4

DIMENSIONS

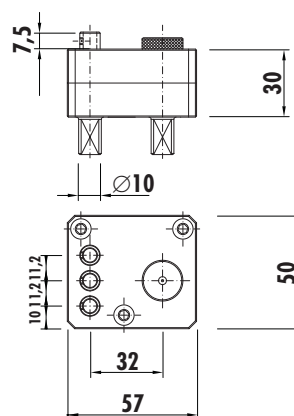

DRILLING JIG FOR MAKING HOLES FOR HINGE INSERTING

TRIMATIC SUPER 32/90° allows to drill at the same time 2 holes perpendicular to the machine boring axis.

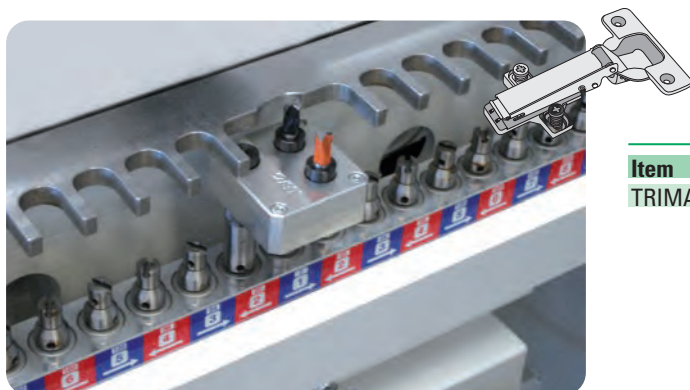

TRIMATIC SUPER 32/90° drilling jig for multi spindles machines 32 mm

HW tools suitable for TRIMATIC SUPER 32/90°

Ø	Description	Rotation
20	L170.200.L	Lh
10	L171.100.R	Rh

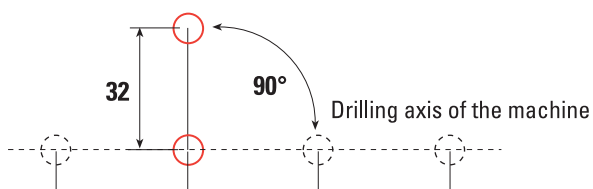

Item
TRIMATIC SUPER 32/90°

DIMENSIONS

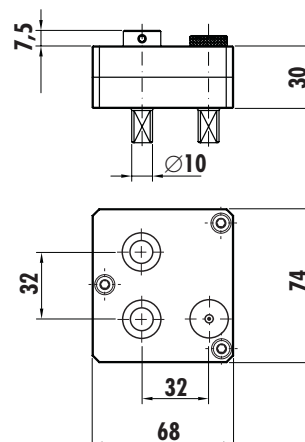

ECCENTRIC CLAMP

The eccentric clamp is suitable for keeping the glued wood sections with comb joints under pressure. It is tightened and slackened by turning the grip; the eccentric pressors are covered in rubber to prevent damage to the wood.

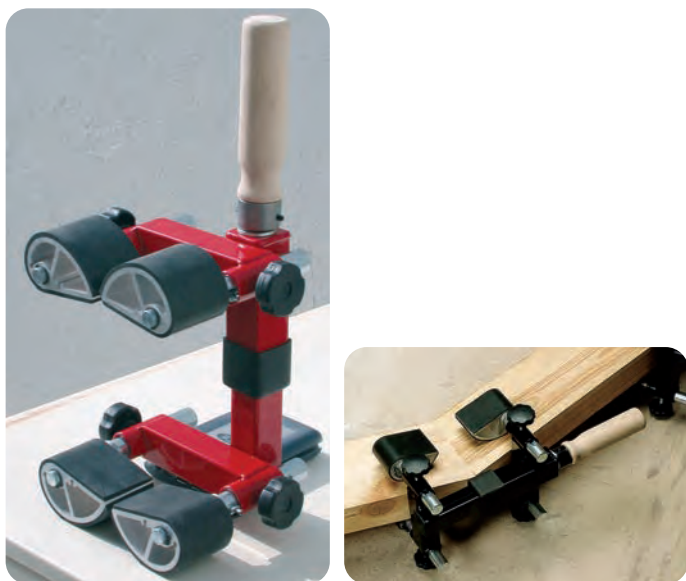

Item	Thickness range
SPP060029	Min. 25 mm - Max 75 mm
SPP060053	Min. 65 mm - Max 110 mm

DRIVER FOR CURVES

The driver for curves was conceived for greater safety during router machining on curves. It is equipped with a motor sufficient to guarantee a regular feed of about 2 m/min. so that a good quality of finish is obtained. The rubber wheel, apart from not damaging the wood, guarantees the perfect position of the piece with respect to the tools. The driver can already be applied with an arc of 25 cm radius.

2 feed rates=1,39 mt/min. + 2,78 mt/min.

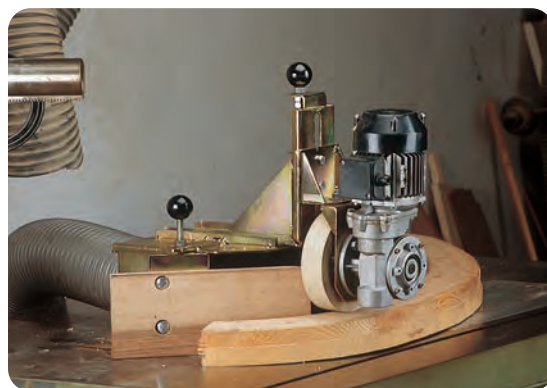

Item	Description
SPP060065	Drivers for curves 2 feed rate

LIFTING CLAMP

The lifting clamp facilitates the handling and transport of large panels. It features an anatomic wooden grip and rubber covered eccentric jaws.



Item	Thickness range
SPP060047	Min. 10 mm - Max 65 mm

EDGE CLAMP

The edge clamp is used to press the wooden lippings against the edge of the panel. The eccentric pressors are covered in rubber. This article is practically indispensable when gluing edge on curved or shaped panels.

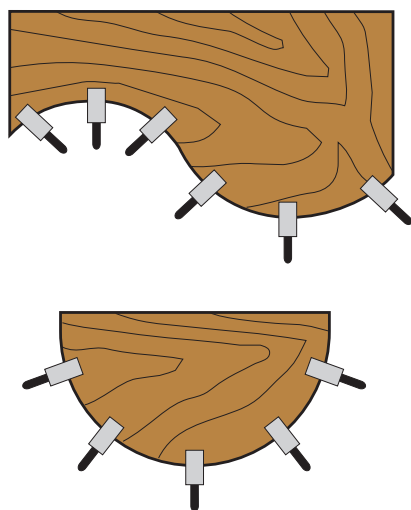
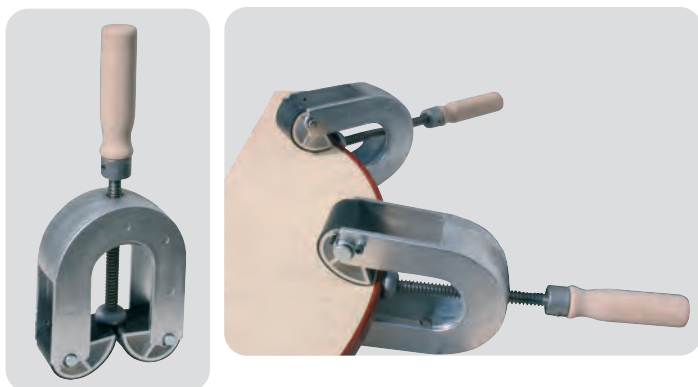

Item	Thickness range
SPP060052	Min. 10 mm - Max 65 mm

CARPENTER'S CLAMP

The carpenter's clamp is suitable for craftsmen who manufacture modern furniture. The clamp is tightened and loosened by turning the wooden handgrip. The ends which hold the panel are covered with ribbed rubber to protect and improve the grip. With a suitable number of extensions furniture of any dimension can be assembled.



Item	Thickness range
SPP020021	Min. 250 mm - Max 800 mm

EXTENSIONS

Item	Thickness range
SPP020022	800 mm

DOOR LIFTER

Lifts, swivels and lowers. Easy foot operation for weights up to 100 kg for the installation of doors including fire doors, windows, furniture, dry walls, partitions.



Item
LIFTER100

QUICK CLAMPING DEVICES

Devices for quick clamping workpieces and for numerous applications. By simply applying pressure on the grip, once dead centre has been passed, they close securely. Horizontal models with horizontal or vertical clamping, push rod and pneumatic. Maximum quality and a virtually unlimited lifespan.



HORIZONTAL TYPE WITH HORIZONTAL CLAMPING

ART. B.ORI



Item	Clamping strength
B.ORI.0240	Kg. 120
B.ORI.0400	Kg. 200
B.ORI.0600	Kg. 300
B.ORI.0700	Kg. 350

HORIZONTAL TYPE WITH VERTICAL CLAMPING

ART. B.VER



Item	Clamping strength
B.VER.0241	Kg. 120
B.VER.0401	Kg. 200
B.VER.0601	Kg. 300
B.VER.0701	Kg. 350

PNEUMATIC TYPE

ART. B.PNE



Operated by a cylinder 6,5 Atm.

Item	Clamping strength
B.PNE.0400	Kg. 200

PUSHER TYPE

ART. B.SPI



Item	Clamping strength
B.SPI.0400	Kg. 220

SPARE ENDPINS

ART. B.PUNTALE



SPARE ENDPINS made in rubber

Item	Description
B.PUNTALE.0240	M6 for B.ORI.0240
B.PUNTALE.0400	M8 for B.ORI.0400
B.PUNTALE.0600	M10 for B.ORI.0600
B.PUNTALE.0700	M12 for B.ORI.0700

KleinWASHER Automatic Tool Washer



Sealants, lubricants, cleaning products see section 14 page 14.03

- Suitable for washing any metal parts and tools from the industry to the smaller workshop
- For tools of various dimensions, also for tool groups for windows thanks to its rotating tank with an height of 350 mm
- Heated biological operating mode
- To be used only with water-based detergent (see our item **KleinCLEANUP**)

Includes:

- Stainless steel housing • Rotating tank D=600 mm • Tank's capacity: 75 L
- Maximum payload: 100 kg • Maximum height of the tools: 350mm
- Stainless steel upper, under and lateral washing arms • Timer
- Thermal resistance • Single-phase 1 hp pump • Dimensions: 940x790 h930 mm
- Dimensions packing: 1210x1050 h1200 mm • Weight: 65 kg

Item	Description
KLEINWASHER	Automatic tool washer

SHRINK FIT UNIT
ART. K.START.2



- Heating time from 2 to 7 seconds
- Provided with inductor stop rings (6 to 12) + (14 to 20) and chuck holder for HSK63F
- Heating located on the tool holder, no deterioration of the tool and tool holder
- Self-regulated power thanks to a microprocessor depending on parameters detected
- Inductor rotates 180° without disassembling
- Power supply 3x380/480V – 16A 50/60 Hz -14 kW
- Dimensions: L= 255 mm - D= 490 mm - H= 755 mm
- Weight (options excluded) 20 kgs

NB: This items cannot be sold in Germany due to commercial agreements between the producer (Elco) and their autorised dealers in these markets.

Item
K.START.2

KleinCLEANER Manual Tool Washer



Sealants, lubricants, cleaning products see section 14 page 14.03

- Can wash any type of tools or metal parts
- Easy to be used with water and spray gun
- Heated biological operating mode

Includes:

- Spray gun
- Tool holding grid
- Stainless steel tank with thermal resistance
- Air-operated double diaphragm pump 5 L/min
- Tank dimensions: 600x500 h 250 mm
- Tank capacity: 70L
- Dimensions: 700x560 h1000 mm
- Dimensions packing: 970x670 h1020
- Weight: 30 Kg

Item	Description
KLEINCLEANER	Manual tool washer

COOLING UNIT WITH AIR FLOW
ART. K.FG500



- Air cooling unit for shrink fit chucks
- Cooling time from 1,30 minute to 3 minutes
- Provided with cooling stop rings (6 to 12) + (14 to 20) and chuck holder for HSK63F
- Compressed air supply: 4-6 bars
- Dimensions: L= 220 mm - D= 190 mm - H= 615 mm
- Weight: 5 kgs

NB: This items cannot be sold in Germany due to commercial agreements between the producer (Elco) and their autorised dealers in these markets.

Item
K.FG500

ANGLE HEADS FOR CNC ROUTING MACHINES

For a quotation on a model not present in this catalogue, please specify:

Type of Machine and model - Type of tool holder (HSK, ISO etc.) - N° of tool exits - Tool used - Application and material to be processed

CNC Aggregate With One Exit Type MONO 90° Function line

ART. GR2.WS.FL

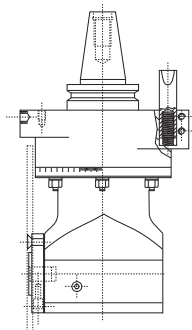

FUNCTION LINE. CNC Aggregate With One Exit

GREASE LUBRICATION

High performance in continuous operation with highest operator ease: these are the features of the aggregates of the FUNCTION LINE.
For Boring, Routing, and Sawing.

Technical Data:

- Machine connection per request
- Speed max.: 10,000 R.P.M. (drive)
- Speed max.: 15,000 R.P.M. (tool spindle)
- Gear ratio i= 1:1,5 - Torque max.: 20 Nm
- Temperature max.: 85° C / 185° F
- Tool interfaces: Collet ER 25, collet ER 32, saw blade connection with flange 30 mm and pitch circle 45 mm, alternatively 52 mm
- In conventional design or alternatively available with modular tool clamping system
- Rotating direction left or right
- Spindle rotating direction same as drive rotating direction
- Position of tool spindle 90°
- Aggregate can be rotated 360° around drive.

Accessories included:

- Collet nut for ER25 - Hook spanner
- 4 torx screws to fix the saw blade to the connection

CNC Aggregate With Two Exits Type DUO

ART. GR2.WZ.FL

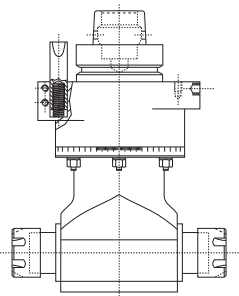

FUNCTION LINE. CNC Aggregate With Two Exits

GREASE LUBRICATION

High performance in continuous operation with highest operator ease: these are the features of the aggregates of the FUNCTION LINE. For Boring, Routing, and Sawing.

Technical Data:

- Machine connection per request - Speed max.: 10,000 R.P.M. (drive)
- Speed max.: 15,000 R.P.M. (tool spindle) - Gear ratio i: 1:1,5
- Torque max.: 20 Nm - Temperature max.: 85° C
- Tool interfaces: Collet ER 25, collet ER 32, saw blade connection with flange 30 mm and pitch circle 45 mm, alternatively 52 mm
- In conventional design or alternatively available with modular tool clamping system
- Rotating direction left or right
- Spindle rotating direction same as drive rotating direction – one tool running same direction, one tool opposite
- Position of tool spindle 90°
- Aggregate can be rotated 360° around drive

CNC Aggregate With Four Exits Type QUATTRO

ART. GR2.WV.FL

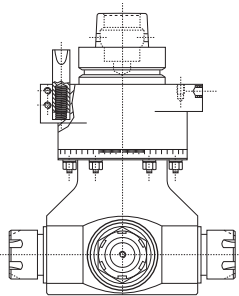

FUNCTION LINE. CNC Aggregate With Four Exits

GREASE LUBRICATION

High performance in continuous operation with highest operator ease: these are the features of the aggregates of the FUNCTION LINE. For Boring, Routing.

Technical Data:

- Machine connection per request
- Speed max.: 10,000 R.P.M. (drive)
- Speed max.: 15,000 R.P.M. (tool spindle)
- Gear ratio i: 1:1,5 - Torque max.: 20 Nm
- Temperature max.: 85° C
- Tool interfaces: collet ER 25 / ER 32, 2 x boring and 2 x routing
- Rotating direction left or right
- Spindle rotating direction same as drive rotating direction – three tools running same direction, one tool opposite direction
- Position of tool spindle 90°
- Aggregate can be rotated 360° around drive

CNC Aggregate With Adjustable Angle And Digital Display - Type VARIO VISO

ART. GR2.WD.FL

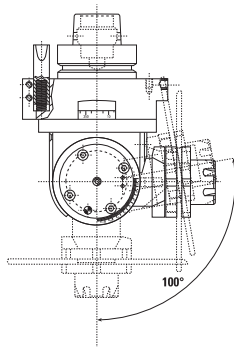

FUNCTION LINE. CNC Aggregate With Adjustable Angle And Digital Display GREASE LUBRICATION

High performance in continuous operation with highest operator ease: these are the features of the aggregates of the FUNCTION LINE. For Boring, Routing, and Sawing.

Technical Data:

- Machine connection per request - Speed max. 15,000 R.P.M. (drive)
- Speed max. 15,000 R.P.M. (tool spindle) - Gear ratio i 1:1
- Torque max. 20 Nm - Temperature max. 85° C / 185° F
- Angle adjustment 0 – 100°
- Tool interfaces: Combination connection ER 25, saw blade or saw blade connection flange 30 mm and pitch circle 45/52 mm with integrated Weldon connection diameter 10 mm
- Rotating direction left or right
- Spindle rotating direction opposite drive rotating direction
- Version with one single clamping screw and digital display of adjusted angle with conical pin for 0° reference adjustment
- Aggregate can be rotated 360° around drive

CNC Aggregate For The Machining Of Panels From Underneath - Type SOTTO

ART. GR2.W1.FL

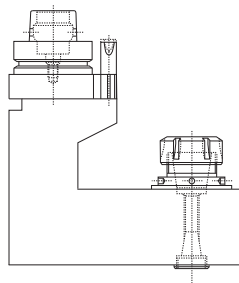

FUNCTION LINE. CNC Aggregate With One Exit From Underneath GREASE LUBRICATION

High performance in continuous operation with highest operator ease: these are the features of the aggregates of the FUNCTION LINE.

Technical Data:

- Machine connection per request
- Speed max. 15,000 R.P.M. (drive)
- Speed max. 15,000 R.P.M. (tool spindle)
- Gear ratio i 1:1
- Torque max. 15 Nm
- Temperature max. 85° C / 185° F
- Tool interface cylindrical 10 mm
- Rotating direction left or right
- Aggregate can be rotated 4 x 90° around drive
- Cycle operation required!

CNC Aggregate Vertical Version With Multiple Spindles In Line - Type VERTI-LINE

ART. GR2.W2.FL

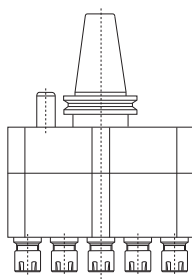

FUNCTION LINE. CNC Aggregate Vertical Version With Multiple Spindles In Line GREASE LUBRICATION

High performance in continuous operation with highest operator ease: these are the features of the aggregates of the FUNCTION LINE. For Boring and Light Duty Routing Operations.

Technical Data:

- Machine connection per request
- Speed max. 10,000 R.P.M. (drive)
- Speed max. 10,000 R.P.M. (tool spindle)
- Gear ratio i 1:1
- Torque max. 15 Nm (drive)
- Temperature max. 85° C / 185° F
- Tool interfaces ER 16 Mini, Weldon 10 mm
- Rotating direction left or right - Rotating direction spindles alternating left/right
- Aggregate can be rotated 360° around drive
- Amount of spindles variable, depending on motor spindle and collision dimensions
- Available with different patterns for hinges etc.

CNC Aggregate With One Exit Type MONO With Oil Lubrication

ART. GR3.WS.UL

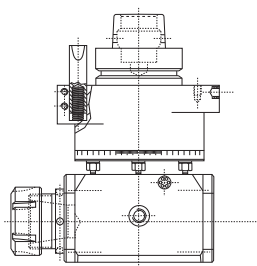

ULTRA LINE. CNC Aggregate With One Exit [90°]

OIL BATH LUBRICATED

No compromises! The aggregates of the ULTRA LINE have been designed for extreme applications in continuous operation, for the use with critical material and for highest loads. Ideal for the use with a large Diameter Saw Blade or a Rough Milling Tool. Using the Optimum Motorspindle Torque and the Optimum Saw Blade/Tool Speed. For Boring, Routing and Sawing.

Technical Data:

- Machine connection per request
- Speed max.: 10,000 R.P.M. (drive)
- Speed max.: 15,000 R.P.M. (tool spindle)
- Gear ratio i: 1:1,5
- Torque max.: 20 Nm
- Temperature max.: 85° C / 185° F
- Tool interfaces: Collet ER 25, collet ER 32, saw blade connection with flange 30 mm and pitch circle 45 mm, alternatively 52 mm
- In conventional design or alternatively available with modular tool clamping system
- Rotating direction left or right
- Spindle rotating direction same as drive rotating direction
- Position of tool spindle 90°
- Aggregate can be rotated 360° around drive

CNC Aggregate With Two Exits Type DUO With Oil Lubrication

ART. GR3.WZ.UL

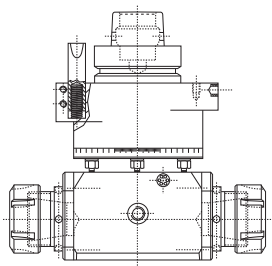

ULTRA LINE. CNC Aggregate With Two Exits

OIL BATH LUBRICATED

No compromises! The aggregates of the ULTRA LINE have been designed for extreme applications in continuous operation, for the use with critical material and for highest loads. For Boring, Routing and Sawing.

Technical Data:

- Machine connection per request
- Speed max.: 10,000 R.P.M. (drive)
- Speed max.: 15,000 R.P.M. (tool spindle)
- Gear ratio i: 1:1,5
- Torque max.: 20 Nm
- Temperature max.: 85° C
- Tool interfaces: Collet ER 25, collet ER 32, saw blade connection with flange 30 mm and pitch circle 45 mm, alternatively 52 mm in conventional design or alternatively available with modular tool clamping system
- Rotating direction left or right
- Spindle rotating direction same as drive rotating direction – one tool running same direction, one tool opposite
- Position of tool spindle 90°
- Aggregate can be rotated 360° around drive

CNC Aggregate With Moulder Spindle And Gear Reduction Now With Integrated Dust Exhaust Type MEGACUTTER

ART. GR3.WX.UL

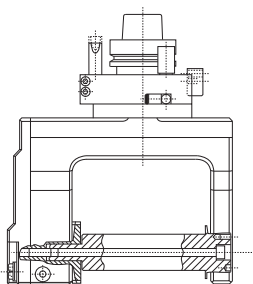

ULTRA LINE. CNC Aggregate For Moulder Knife tool

OIL BATH LUBRICATED

No compromises! The aggregates of the ULTRA LINE have been designed for extreme applications in continuous operation, for the use with critical material and for highest loads. Ideal For The Use With a Moulder Spindle or a Saw Blade Package. Using The Optimum Motorspindle Torque And The Optimum Saw Blade/Tool Speed.

Technical Data:

- Machine connection
- Speed max. 11.380 R.P.M. (drive)
- Speed max. 7,690 R.P.M. (tool spindle)
- Gear ratio i = 1:0,641
- Torque max. 20 Nm
- Temperature max. 85° C / 185° F
- Tool interfaces: arbour with 30 mm diameter, 120 clamping length
- Rotating direction left or right
- Spindle rotating direction same as drive rotating direction
- Position of tool spindle 90°
- Aggregate can be rotated 360° around drive

CNC Aggregate With Adjustable Angle Type VARIO VISO With Oil Lubrication

ART. GR3.WD.UL

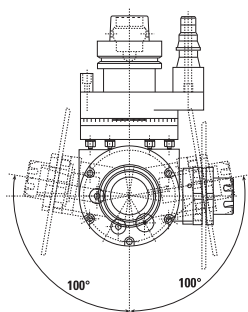

ULTRA LINE. CNC Aggregate With Adjustable Angle

OIL BATH LUBRICATED

No compromises! The aggregates of the ULTRA LINE have been designed for extreme applications in continuous operation, for the use with critical material and for highest loads. For Boring, Routing and Sawing.

Technical Data:

- Machine connection per request
- Speed max. 13.760 R.P.M (input)
- Speed max. 15.000 R.P.M (output)
- Gear ratio i 1:1,09
- Torque max. 22 Nm
- Temperature max. 85° C / 185° F
- Angle adjustment 2 x 0 – 100°
- Tool interfaces Combination connection ER 25/saw, collet connection ER 25 as well as saw blade connection with flange 30 mm, pitch circle 45 mm, alternatively 52 mm
- Rotating direction left or right
- Spindle rotating direction opposite drive rotating direction
- Adjustment regulation with nonius
- Aggregate can be rotated 360° around drive

DISPLAYS

BASE - STANDARD - PROFESSIONAL, these are the new displays **Klein** designed to have a modular system of slatted panels with two, three or four rows of hooks on which to hang products. In order to exhibit not packed items one or more shelves can be also hung. Standard and Professional displays can be supplied with sliding glass windows and locked with a safety lock. The great flexibility and visibility of the product assortment in the new displays improve the offer range and thus the service to customers.



Klein®

BASE

1 modular panel

Small display, ideal for starting with a basic assortment
Dimensions (cm): 110 (L) x 90 (H) x 30 (P)

**Display
 customizable**



Display code **Base 01**
 includes:
 Router bits S=6/8
 for portable routers
60 positions



Display code **Base 02**
 includes:
 Router bits S=12
 for portable routers
30 positions



Display code **Base 03**
 includes:
 Router bits for Elu machines
 code **F101**
 "Forstner" bits code **R213**
 Hinge boring bits code **R111**



Display code **Base 04**
 includes:
 Insert router bits
 "Novasystem"

SOME MORE EXAMPLES OF DISPLAYS "BASE"



Mortising bits code **S202**
 Diamond whetstones **DMT**

Circular saw blades
 for portable saws



STANDARD

2 modular panels

Consisting of two displays "BASE", can be composed according to customers' needs.
Suitable for those who want a good variety of products waiting to increase and improve the offer range.

Dimensions (cm): 110 (L) x 145 (H) x 36 (P)

Display code **Standard 01**
includes:
Router bits S=6/8 for portable routers
120 positions

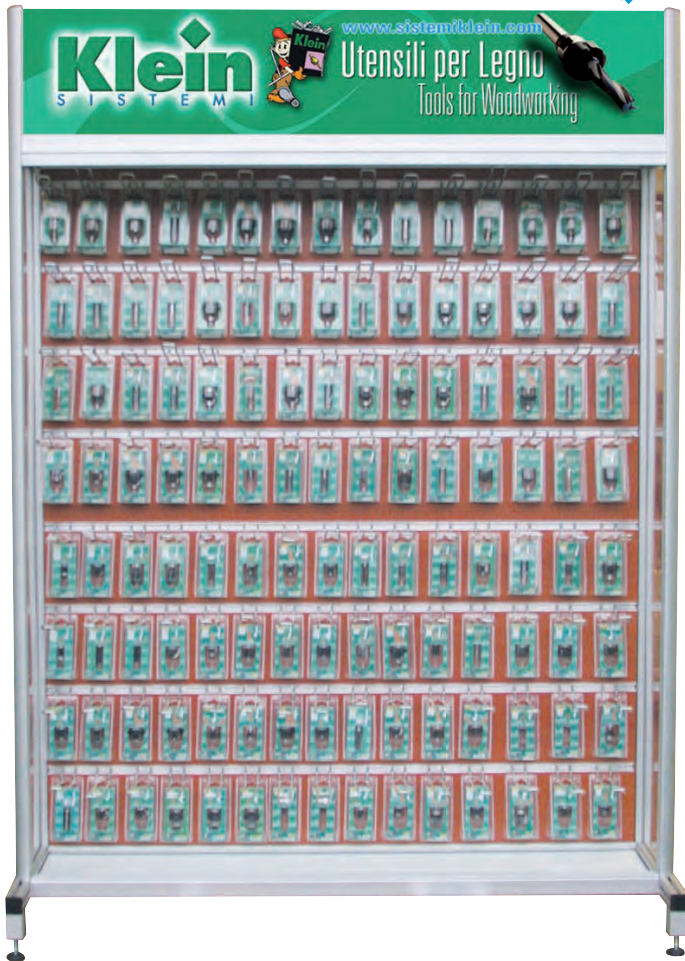

**Display
customizable**

Display code **Standard 02**
includes:
Router bits S=12 for portable routers
60 positions

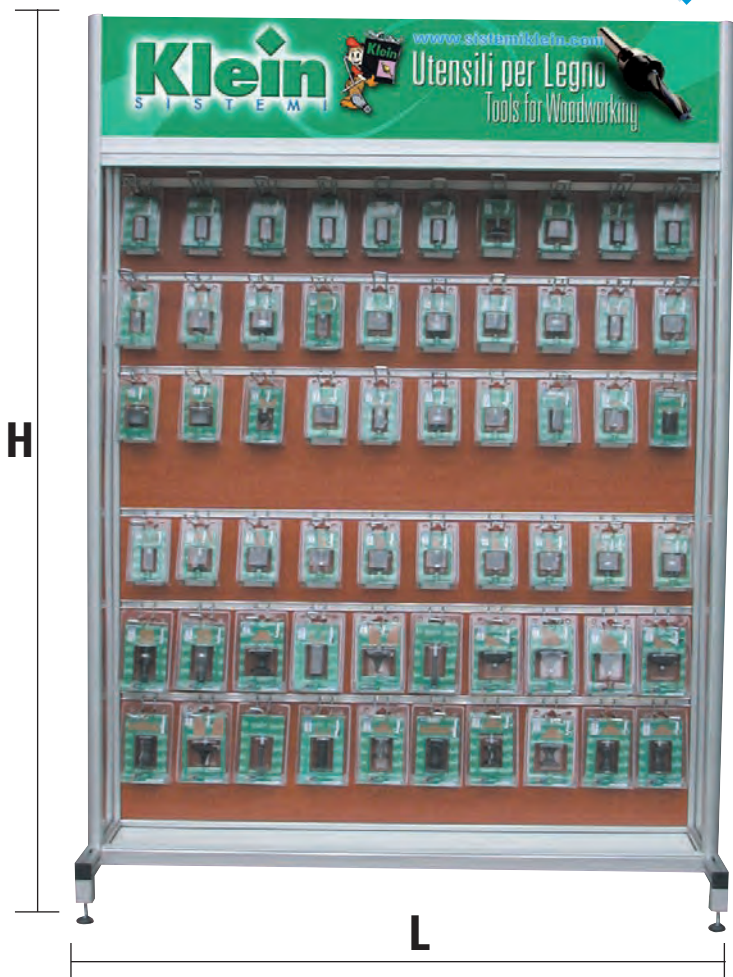

SOME MORE EXAMPLES OF DISPLAYS "STANDARD"



Router bits S=6/8 for portable routers
60 positions
 Router bits for ELU machines code **F101**
 "Forstner" bits code **R213**
 Hinge boring bits code **R111**

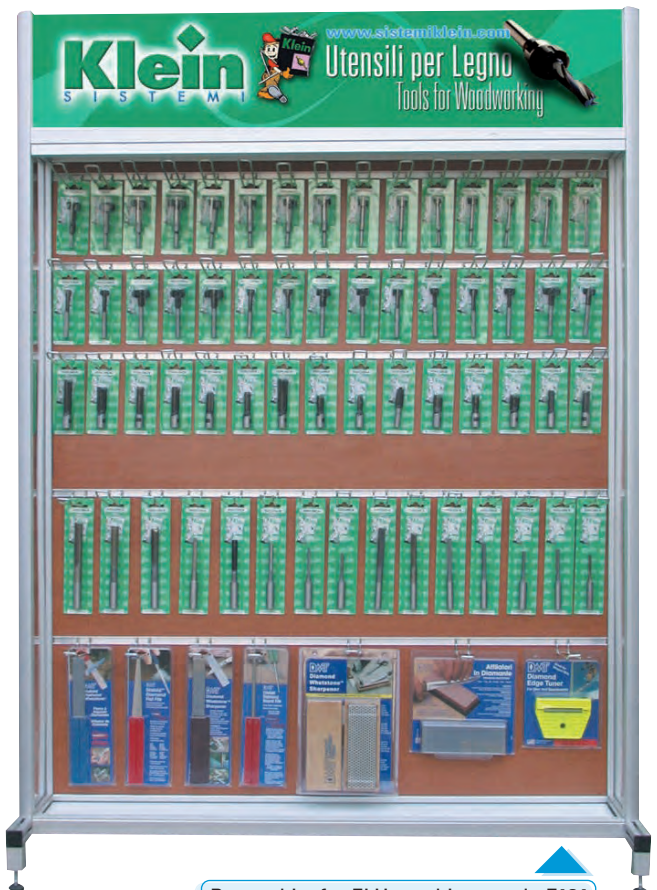

Router bits for ELU machines code **F101**
 "Forstner" bits code **R213**
 Hinge boring bits code **R111**
 Mortising bits code **S202**
 Diamond whetstones **DMT**



Router bits S=6/8 for portable routers
60 positions
 Circular saw blades for portable saws

PROFESSIONAL

3 modular panels

Big display consisting of three panels BASE, allows you to display a large variety of items.
With two or more displays you get the complete assortment to meet all the needs of professional woodworkers.

Dimensions (cm): 110 (L) x 200 (H) x 36 (P)

**Display
customizable**

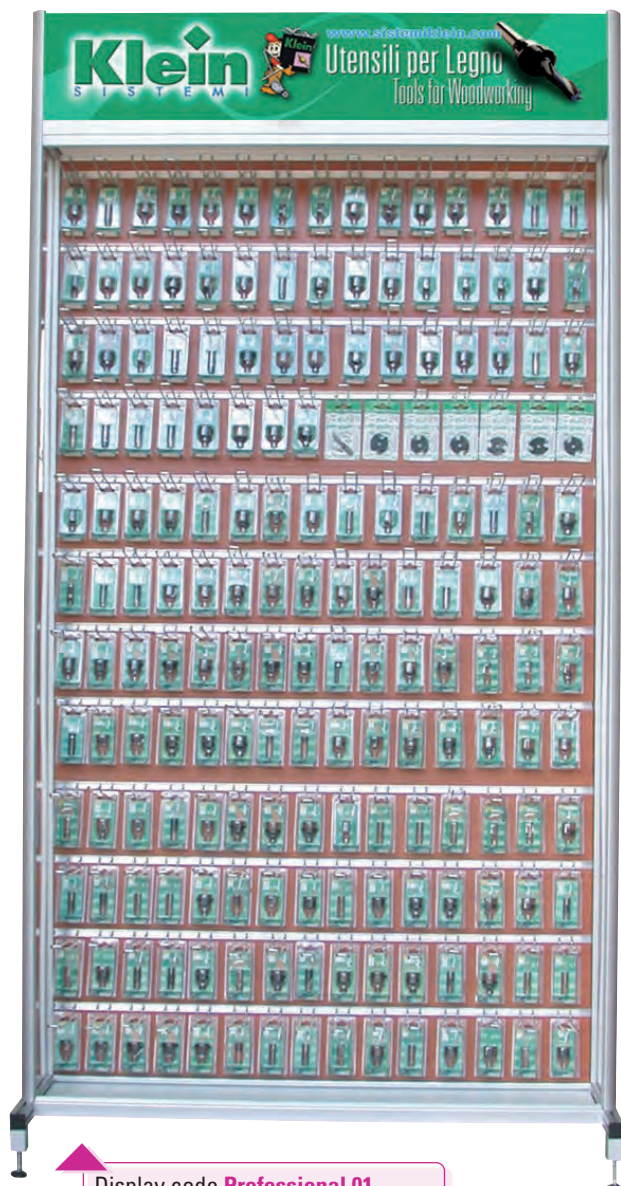

Display code **Professional 01**
includes:
Router bits for portable routers
S= 6/8 - 180 positions

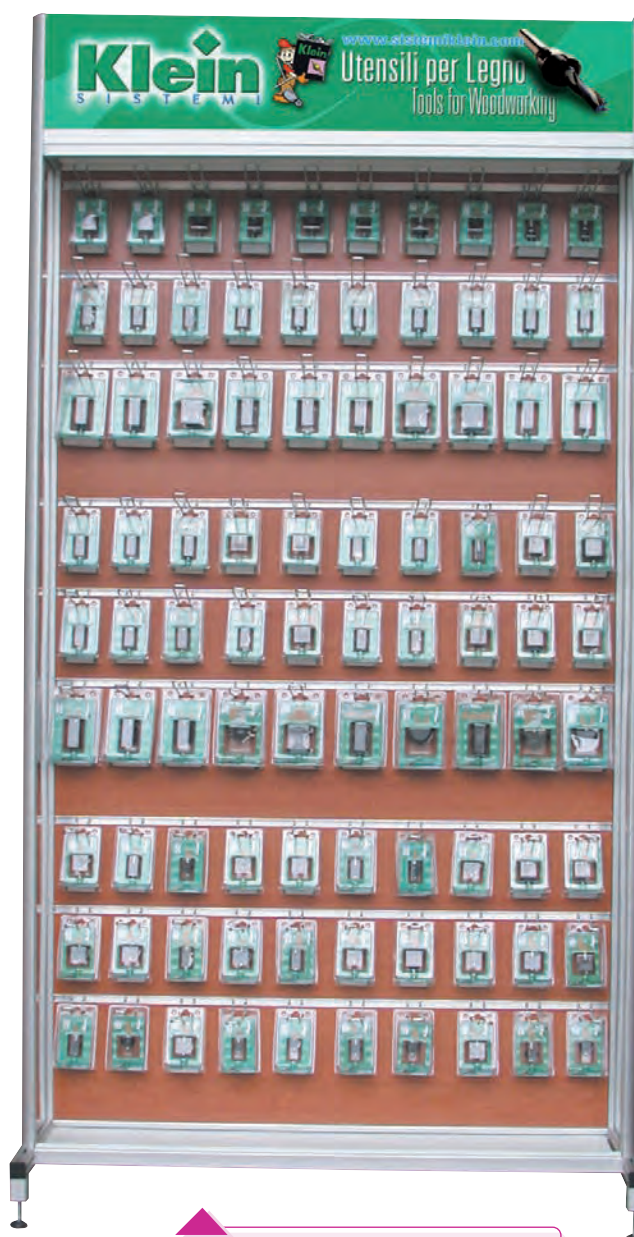

Display code **Professional 02**
includes:
Router bits for portable routers
S= 12 - 90 positions

SOME MORE EXAMPLES OF DISPLAYS "PROFESSIONAL"

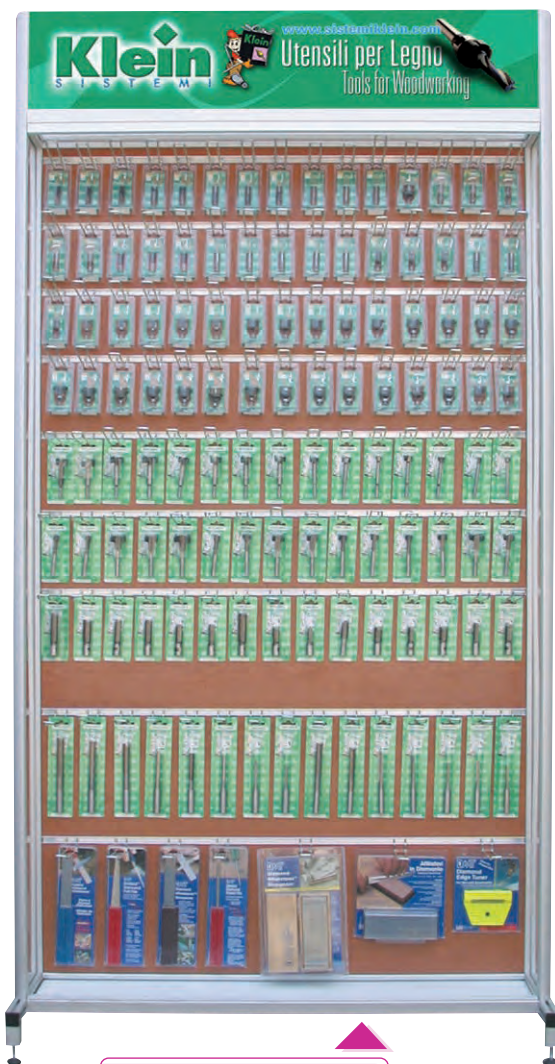

Router bits S=6/8 for portable routers
60 positions
 ELU machines code **F101**
 "Forstner" bits code **R213**
 Hinge boring bits code **R111**
 Mortising bits **S202**
 Diamond whetstones **DMT**



Router bits S=6/8 for portable routers
60 positions
 Router bits for ELU machines code **F101**
 "Forstner" bits code **R213**
 Hinge boring bits code **R111**
Circular saw blades for portable saws

Router bits S=6/8 for portable routers
60 positions
 ELU machines code **F101**
 "Forstner" bits code **R213**
 Hinge boring bits code **R111**
 Diamond whetstones **DMT**
 Accessories

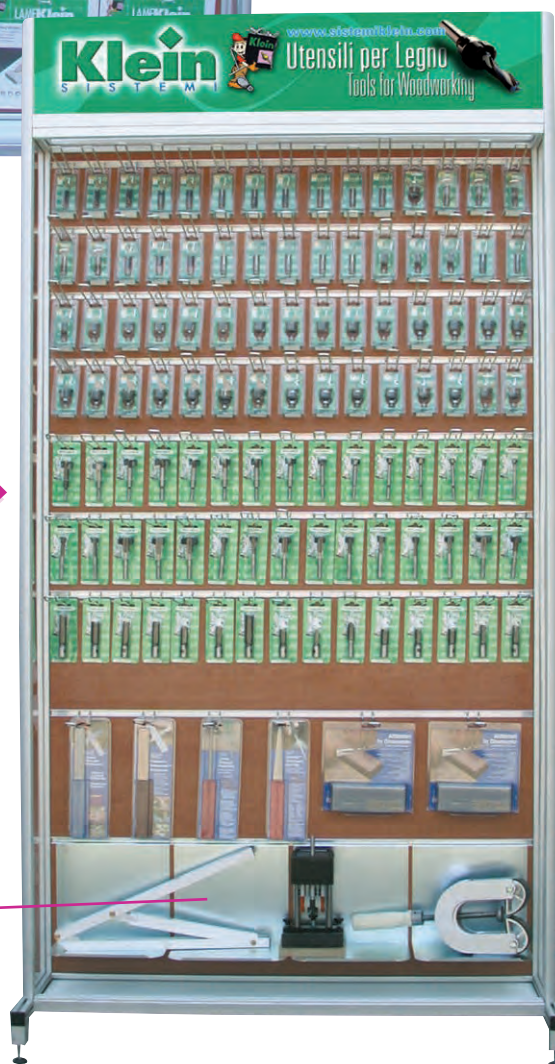

Aluminium shelf fitting on slatted panels with two rows for displaying products without hanging packaging



DRAWER UNIT

Modular drawer unit

Elegant, sturdy **Klein** drawer unit with an innovative, modern design and great modularity, where you can keep all your **Klein** tools in a clean, secure, well-organized place. Say good-bye to messiness and damaged tools. Now, with the new **Klein** drawer unit, you can put your storeroom in order in a convenient, functional way.

Dimensions (cm): 50 (L) x 110 (H) x 37 (P)



SMALL OUTSIDE BUT LARGE INSIDE
the **Klein** drawer unit takes up little space but can contain countless articles in its 10 drawers and 80 containers (8 containers per drawer).

- STURDY

since each drawer can hold around 8 kg.

- LIGHT

since it's made of a high-strength polypropylene co-polymer.

- SECURE

since each drawer has its own key.

- PRACTICAL

since it can be equipped with 4 casters for convenient movement or with slip-resistant feet.

- CONVENIENT

since it features a wooden top which acts as a practical surface for taking notes or keeping tools.

- VERSATILE

since the tubs in the drawers can be removed easily as desired.

Whether it's placed next to a CNC router, or close to a point-to-point boring machine, along the panel production line or in any carpentry shop, a new **Klein** drawer unit can be a real help in keeping the tools you use every day in perfect order and in good condition.



The new **Klein** drawer unit can hold a wide range of tools.

Ask our customer service how to receive it.



You can receive the new modular drawer by purchasing the following products

The drawer unit can be customized by replacing one or more drawers with others and/or replacing one or more single articles with others at your wish. The personalization must be agreed with our Customer Service

Modular drawer unit "Boring Machine"

Ideal to store dowel drills and boring bits beside your boring machine



1st Drawer

Drill holders

- Art. L001.100.R
- L001.100.L
- L002.100.R
- L002.100.L
- L030.100.R
- L030.100.L
- L031.100.R
- L032.100.R

2nd Drawer

Drills L=57,5

- Art. L103.040.R
- L103.040.L
- L103.050.R
- L103.050.L
- L103.060.R
- L103.060.L
- L103.070.R
- L103.070.L

3rd Drawer

Drills L=57,5

- Art. L103.080.R
- L103.080.L
- L103.100.R
- L103.100.L
- L103.120.R
- L103.120.L
- L103.140.R
- L103.140.L

4th Drawer

Drills L=70

- Art. L104.040.R
- L104.040.L
- L104.050.R
- L104.050.L
- L104.060.R
- L104.060.L
- L104.070.R
- L104.070.L

5th Drawer

Drills L=70

- Art. L104.080.R
- L104.080.L
- L104.100.R
- L104.100.L
- L104.120.R
- L104.120.L
- L104.140.R
- L104.140.L

6th Drawer

Through hole drills

- Art. L124.050.R
- L124.050.L
- L124.060.R
- L124.060.L
- L124.080.R
- L124.080.L
- L124.100.R
- L124.100.L

7th Drawer

Hinge boring bits

- Art. L140.150.R
- L140.150.L
- L140.180.R
- L140.180.L
- L140.200.R
- L140.200.L
- L140.250.R
- L140.250.L

8th Drawer

Hinge boring bits

- Art. L140.260.R
- L140.260.L
- L140.300.R
- L140.300.L
- L140.350.R
- L140.350.L
- L140.400.R
- L140.400.L

9th Drawer

High performance drills L=57,5

- Art. L114.050.R
- L114.050.L
- L114.060.R
- L114.060.L
- L114.080.R
- L114.080.L
- L114.100.R
- L114.100.L

10th Drawer

High performance drills L=70

- Art. L115.050.R
- L115.050.L
- L115.060.R
- L115.060.L
- L115.080.R
- L115.080.L
- L115.100.R
- L115.100.L

Modular drawer unit "CNC"

Ideal to store collet chucks, spring collets and spiral router bits beside your CNC machine



1st Drawer

Spring collets ER32

- Art. T119.060.N
- T119.080.N
- T119.100.N
- T119.120.N
- T119.140.N
- T119.160.N
- T119.180.N
- T119.200.N

2nd Drawer

Spring collets ER40

- Art. T123.080.N
- T123.100.N
- T123.120.N
- T123.140.N
- T123.160.N
- T123.180.N
- T123.200.N
- T123.250.N

3rd Drawer

Collet chucks and spring collets ER25

- Art. T118.700.R
- T118.800.R
- T118.976.R
- T118.980.R
- T125.060.N
- T125.080.N
- T125.100.N
- T125.120.N

4th Drawer

Spiral router bits Z=2

- Art. T142.040.R
- T142.050.R
- T142.061.R
- T142.080.R
- T142.081.R
- T142.100.R
- T142.101.R
- T142.121.R

5th Drawer

Spiral router bits Z=3

- Art. T143.081.R
- T143.100.R
- T143.101.R
- T143.121.R
- T143.161.R
- T143.180.R
- T143.200.R
- T143.201.R

6th Drawer

Spiral router bits Z=3 + chipbreaker

- Art. T144.081.R
- T144.100.R
- T144.101.R
- T144.121.R
- T144.161.R
- T144.180.R
- T144.200.R
- T144.201.R

7th Drawer

Spiral router bits Z=1

- Art. T141.030.R
- T141.040.R
- T141.050.R
- T141.061.R
- T141.081.R
- T141.100.R
- T151.061.R
- T151.081.R

8th Drawer

Spiral router bits Z=2 down-cut

- Art. T152.030.R
- T152.040.R
- T152.050.R
- T152.061.R
- T152.080.R
- T152.081.R
- T152.101.R
- T152.121.R

9th Drawer

Spiral router bits for locks

- Art. T153.100.R
- T153.120.R
- T153.160.R
- T154.081.R
- T154.120.R
- T154.160.R
- T157.140.R
- T157.162.R

10th Drawer

Straight cut router bits

- Art. D101.080.R
- D101.100.R
- D102.100.R
- D103.121.R
- D103.141.R
- D103.161.R
- D103.181.R
- D103.201.R

Modular drawer unit "Craftsman"

Ideal to store the most common tools in a workshop



1st Drawer

Router bits S=M12x1

- Art. F101.080.R
- F101.100.R
- F101.120.R
- F101.160.R
- F101.180.R
- F101.200.R
- F101.220.R
- F101.250.R

2nd Drawer

Router bits S=M12x1

- Art. F103.120.R
- F103.160.R
- F103.180.R
- F103.200.R
- F104.120.R
- F104.160.R
- F104.200.R
- F105.160.R

3rd Drawer

Hinge boring bits L=90

- Art. R111.150.R
- R111.180.R
- R111.200.R
- R111.250.R
- R111.260.R
- R111.300.R
- R111.350.R
- R111.400.R

4th Drawer

Forstner bits

- Art. R213.150.R
- R213.160.R
- R213.180.R
- R213.200.R
- R213.250.R
- R213.300.R
- R213.350.R
- R213.400.R

5th Drawer

Interchangeable hinge boring bits

- Art. R130.200.R
- R130.250.R
- R130.260.R
- R130.300.R
- R130.340.R
- R130.350.R
- R130.400.R
- Z021.408+410+412

6th Drawer

Interchangeable hinge boring bits

- Art. R130.450.R
- R130.480.R
- R130.500.R
- R130.550.R
- R130.600.R
- R130.650.R
- R130.700.R
- Z021.213+216+500

7th Drawer

Mortising bits R

- Art. S202.060.R
- S202.080.R
- S202.100.R
- S202.120.R
- S202.140.R
- S202.160.R
- S202.180.R
- S202.200.R

8th Drawer

Mortising bits L

- Art. S202.060.L
- S202.080.L
- S202.100.L
- S202.120.L
- S202.140.L
- S202.160.L
- S202.180.L
- S202.200.L

9th Drawer

Plug cutters

- Art. R220.080.R
- R220.100.R
- R220.120.R
- R220.150.R
- R220.200.R
- R220.250.R
- R220.300.R
- R220.350.R

10th Drawer

Reversible knives

- Art. Z055.000.N
- Z055.001.N
- Z055.003.N
- Z055.007.N
- Z055.008.N
- Z055.009.N
- Z055.010.N
- Z055.011.N

Instructions of use:

SAFE HANDLING:

 All European and National safety regulations shall be adhered to include the safety requirements as set out in EN 847-1.

TRANSPORT :

 Transport only in suitable packaging. Danger of damaging the cutting parts.

 **Caution:** danger of injuring by sharp cutting edges! Wear safety gloves.

ASSEMBLING THE TOOL AND SETTING THE MACHINE:

 Inspect the tool body and cutting parts for damage before mounting it in the machine. Damaged tools are to be checked by an expert. Do not use a deformed tool. All clamping area shall be free of pollution, grease, oil and water. Tighten clamping screws and nuts by using appropriate spanners and the recommended torque value. Danger of injuring by parts coming off!

 While mounting, it shall be ensured, that the tool is clamped on the special clamping area. Cutting parts shall not come in contact with clamping elements and/or machine parts. When using stacked tooling ensure that the cutting parts do not foul each other. Check the cutting parts and basic bodies for damages.

 The tools shall be mounted, locked and activated as per instructions of the machine manufacturer. Check the machine data and the direction of rotation.

 Starting the machine during the tool, change is not allowed (see handling instructions of the machine). Danger of injuring! Improper stopping of the tool, e.g. by lateral pressing, is not allowed.

 After a tool breakage the collets also have to be exchanged. Tools with cracked bodies have to be taken out of service. Repairing such tools is not allowed. Carefully demount the tool.

MAINTENANCE:

Clean the collet and the tool holder regularly and before inserting the tool. Regular cleaning increases the operational safety. For reason of working safety, the cutting parts at the latest have to be serviced when:

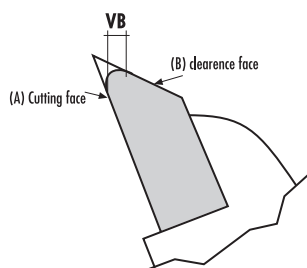

When the wear mark VB on the cutting parts has become more than 0.2mm – especially observe the main wear zones. (see section Servicing, modifying, sharpening)

 Woodworking tools are to be protected against humidity in order to avoid corrosion. The cutting parts have to be regularly cleaned from resin and glue (built-up edges) this increasing thus the performance time and the operational safety.

 Detergent can irritate skin and eyes and damage the tool. Protect hands and eyes while cleaning. Only use appropriate detergents and follow the instruction of the detergent producer.

Instructions of use:

SERVICING, MODIFYING AND SHARPENING:



Only experienced specialists are allowed to sharpen the tools as per instructions of the manufacturer.



Service and modification shall only be done by the manufacturer or by specialised workshops. Risk of tool-breakage. Only those spare parts are allowed to be used, which match the requirements of the original spare parts of the tool manufacturer. Tolerances, that guarantee a precise clamping, have to be kept.



Markings of the tool, which have been affected by modification / re-tipping, have to be updated. Name and logo of the modifying / re-tipping company have to be added. Specialists/specialized workshops shall be experienced in the relevant:

- up-to-date engineering referring construction and design;
- national regulation;
- appropriate safety regulations and standard.

They shall have:



- the standard equipment and
- the capability of doing these operations.

After any sharpening, servicing or modification process, it shall be ensured, that the tool meets the requirements of the European Standard EN 847-1, EN 847-2 and EN 847-3.



Re-tipping of cutting plates is only allowed by specialists who are experienced in brazing process referring tensions in the body and the cutting material. The design of composite tools (e.g. tools with brazed cutting plates) is not allowed to be changed.

Symbols

	Consult service manual
	Insert safety lock before getting in hazardous area
	General modatory action
	Wear safety gloves
	Danger (general prohibition)
	Do not operate with damaged blade
	General danger

Safety regulations

The most important rules in the production of tools are regulated by the European standards En 847, sections 1 to 3 "Tools for Woodworking - Safety requirements". Here are defined the minimum requirements to which, according to the current state of technology, must meet a tool for working wood, in order to be considered safe.

European standards:

EN 847-1	EN 847-1 Milling tools, circular saw blades
EN 847-2	EN 847-2 Requirements for the shank of shank-mounted milling tools
EN 847-3	EN 847-3 Requirements for clamping devices

Wood

Wood is a natural resource that is both always renewable and crucial to mankind. Other resources come to an end, but wood will always be there, as long as we look after our forests and only cut down plants once they are fully grown, so that can give new plants the space they need to grow. Wood is healthy, strong, durable and diverse, and is available in an infinite range of colours, grains, shades and knots. A wood product will never be an exact copy of another; it will always be inimitable and exceptional.



HARDNESS:

Wood is classified according to its hardness into one of three categories: hardwood, semi-hardwood or softwood. This order respects its values as well. Exotic woods are among the hardest ones, which is why they are held in greater esteem. Nonetheless, others include our native hornbeam, boxwood, acacia, olive tree, pear tree and ash - just to name some of the most popular hardwoods used in modern woodworking. In terms of semi-hardwoods, some of the most commonly used are cherry, beech, chestnut, walnut, elm, plane tree and alder, while the following are softwoods: fir, birch, poplar and linden. Balsa and samba (exotic) are so soft that they can be scratched using your nails.

LIGHT AND HEAVY:

some woods sink like stones as soon as they are placed in water, others instead are as light as polystyrene. Some woods are beautiful, others are not particularly attractive, but all are useful. Recognising different types of woods without hesitating, weighing up their potential and being able to see how they can be used to the best of their advantage are essential skills required of all those who want to work with wood in a proficient manner and achieve good results. Wood is classified according to its origin, and can be either European or exotic. The first, obviously, comes from trees that grow on the European continent, such as birch, elm, linden, maple, walnut etc., and include a number of resinous woods, such as fir, pine, Swiss pine, cypress, yew and larch. The second are exotic tree species from continents other than Europe (North America, Africa, etc.). Without wanting to disparage local woods, we must say that the latter are held in higher regard as a whole.

The most popular woods for woodworking



Cherry



Ebony



Beech

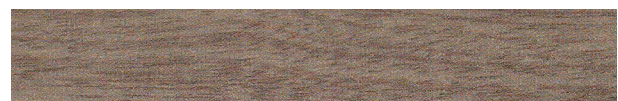

Mahogany

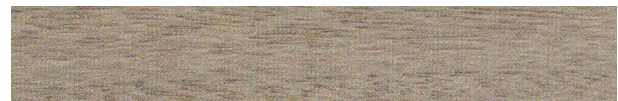

Walnut



Rosewood

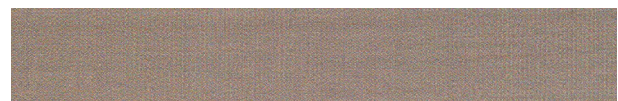

Pera Tree



Pine

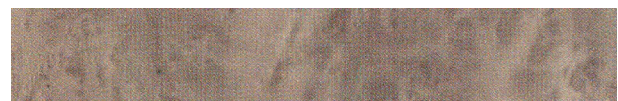

Briarwood



Oak

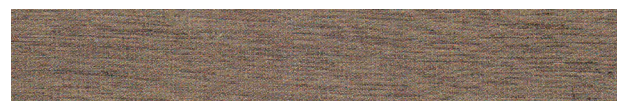

Teak



Wengè

General sale conditions

Unless otherwise agreed in writing

ORDERS

Whether direct or indirect, these are only accepted with our approval and irrevocable on the part of the purchaser.

PRICES

Are only a guide and are not binding. Those correct at the time of forwarding will be applied.

Prices for special tools may be varied at any time to allow for increased costs of materials and manufacturing as well as any further costs arising during the time taken to execute the order.

PACKAGING

Is always invoiced at cost price.

FORWARDING

Ex-factory (Pesaro). Goods always travel at the purchaser's risk. In the case of forwarding by postal service, Sistemi s.r.l. can accept no responsibility for goods which fail to arrive at destination or which arrive damaged in any way.

DELIVERY

Is not binding and therefore, apart from our company being exonerated from any claims, it is implicitly dependent upon the supply of raw materials as well as any production difficulties arising due to events beyond our control.

GARANTEE

Under conditions of normal usage we undertake to replace tools we consider to be defective.

This guarantee does not extend to tools showing normal wear and tear, evidence of damage or tools which have been used incorrectly.

CLAIMS

Must be made in writing within 8 days upon receipt of goods. If the claim is made within the specified limits, is valid and justified, the purchaser has the exclusive right to substitution of good or credit for the same amount, excluding any other indemnity from the company.

SMALL ORDERS

For administrative reasons the minimum order value is set at 100,00 €.

SPECIAL TOOLS

In cases where these are specifically requested, the order carried out may involve quantities higher or lower than those specified in the order, depending on the number of items.



PAYMENT TERMS

Must be made directly to our head office in the form agreed. If payment is delayed for any reason, interest at bank rates will accrue from the date payment is due, including any eventual further expenses.



JURISDICTION

In the case of any legal contention the Court of PESARO will have full power of jurisdiction.













Item and Page Index

Item	Page	Item	Page	Item	Page
A101/2/3 - B101/2/3 - C101/2/3	1.07, 1.08	A165 - B165 - C165	1.22	CDS.X6F	12.30
A104 - B104 - C104	1.08	A166 - B166 - C166	1.22	CDT 	12.28
A105 - B105 - C105	1.10	A167 - B167	1.23	CE-CES	12.29
A106 - C106	1.10	A168 - B168	1.23	CERT.	15.21
A107 - B107 - C107	1.10	A169 - B169	1.23	CES.X6F	12.30
A108 - B108 - C108	1.10, 1.11	A170 - C170	1.23	CET 	12.29
A109 - B109 - C109	1.11	A180 - B180	1.23	CF	12.31
A109 - B109	8.13	A181 - C181	1.24	CG	12.31
A110 - B110 - C110	1.11	A182 - C182	1.24	CH	12.32
A111 - B111 - C111	1.12	A185	1.24	CP	12.33
A112 - B112 - C112	1.12	A186 - B186	1.24	D101	2.07
A113 - B113 - C113	1.12	A191	1.24	D102	2.07
A114 - C114	1.12	A195 - C195	1.24	D103	2.07
A115 - B115 - C115	1.12	A196 - B196 - C196	1.24	D4	14.07
A116 - B116 - C116	1.13	A199	1.25, 6.04	D6	14.07
A117 - B117 - C117 - E117 - G117	1.13, 1.14, 2.15	A4	14.04	DA	12.33
A118	1.13	AA	12.18, 12.19	DC	12.34
A119 - B119 - C119	1.14	AB	12.20	DIGIT950	15.22
A120 - B120 - C120	1.15	AH	12.23, 13.03	DIGIT950	15.26
A121 - B121 - C121	1.15	AL	12.20	DIGIT955	15.22
A122 - B122 - C122	1.15	AG	1.25	DIGIT980/985/986/987	15.25
A123 - B123 - C123	1.16	ANGOLFAST	15.14	DIGIT990	15.23
A124 - B124 - C124	1.16	AP	12.21	DIGIT990	15.26
A125 - B125 - C125	1.16	AR	12.22	DIGIT991	15.23
A126 - B126 - C126	1.17	ARKADE	16.03	DIGIT992	15.24
A127 - B127 - C127	1.17	AT	12.22	DISPLAY UNITS	XI÷XVI
A128 - B128 - C128	1.17	B.ORI	16.15	DL	12.35
A129 - B129 - C129	1.17	B.PNE	16.15	DOOR LIFTER	16.14
A130 - B130 - C130	1.17	B.PUNTALE	16.15	DRAWER UNIT	XVII
A131 - B131 - C131	1.17	B.SPI	16.15	DRIVER FOR CURVES	16.13
A132 - B132 - C132	1.17	B.VER	16.15	E101 - G101	2.07
A133 - B133 - C133	1.18	B139	1.18	E102 - G102	2.08
A134 - B134 - C134	1.18	BCE	15.28, 15.29	E103 - G103	2.08
A135 - B135 - C135	1.18	C.DIGIT.Z3	15.14	E104 - G104	2.08
A136 - B136 - C136	1.18	C.INT	15.16	E105 - G105	2.08
A137 - B137 - C137	1.18	C.INV	15.16	E106 - G106	2.08
A138 - B138	1.18	C.L45	15.20	E107 - G107	2.08
A141 - B141	1.19	C.LETTORE	15.21	E108 - G108	2.08
A142 - B142	1.19	C.LIE	15.17	E109 - G109	2.09
A143 - B143	1.19	C.LIE.PA	15.17	E110 - G110	2.09
A144 - B144	1.19	C.LIN	15.15	E111 - G111	2.09
A145 - C145	1.19	C.LIN.D	15.20	E112 - G112	2.09
A146 - C146	1.19	C.LIN.L	15.19	E113 - G113	2.09
A147 - B147 - C147	1.20	C.LIN.L.PA	15.19	E114 - G114	2.09
A150 - C150	1.20	C.LIN.PA	15.15	E115 - G115	2.10
A151 - C151	1.20	C.LIN.PB	15.18	E116 - G116	2.10
A152 - C152	1.20	C.LIN.PI	15.18	E118 - G118	2.10
A153 - B153 - C153	1.20	C112	1.12	E119 - G119	2.10
A154 - C154	1.20	C118	1.13, 1.14, 2.15	E120 - G120	2.10
A155	1.20	C173	1.13, 8.13	E121 - G121	2.10
A156	1.21	C175	1.10	E122 - G122	2.11
A157 - B157	1.21	C190	1.08	E123 - G123	2.11
A158 - B158	1.21	C192	1.25, 6.08	E124 - G124	2.11
A159 - B159	1.21	C323	1.16 - 3.07	E125 - G125	2.11
A160 - B160 - C160	1.21	CA	12.26	E127 - G127	2.11
A161 - B161	1.22	CARPENTER'S CLAMP	16.14	E128 - G128	2.11
A162 - B162	1.22	CB-CBS	12.27	E129 - G129	2.11
A163 - B163	1.22	CCS	12.27	E130 - G130	2.12
A164 - B164	1.22	CD-CDS	12.28	E131 - G131	2.12

Item and Page Index

Item	Page	Item	Page	Item	Page
E132 - G132	2.12	E199 - C199	2.22	FH	12.40
E133	2.12	E300 - G300	3.05	FI	12.46
E134 - G134	2.12	E301 - G301	3.05	FK	12.41
E135 - G135	2.13	E302 - G302	3.05	FL	12.48
E136 - G136	2.13	E305 - E306 - E307	3.05	FM	12.53
E137 - G137	2.13	E310 - G310	3.06	FP	12.53
E138 - G138	2.13	E312 - G312	3.06	FR	12.54
E139 - G139	2.13	E315	3.06	FSK	14.05
E140 - G140	2.13	E316 - G316	3.06	FW	14.05
E141 - G141	2.14	E317 - G317	3.06	GA	12.34
E142 - G142	2.14	E321	3.07	GR2.W1.FL	16.18
E143 - G143	2.14	E325 - G325	3.07	GR2.W2.FL	16.18
E144 - G144	2.14	E326 - G326	3.07	GR2.WD.FL	16.18
E145 - G145	2.14	E330 - G330	3.07	GR2.WS.FL	16.17
E146 - G146	2.16	E334 - G334	3.08	GR2.WV.FL	16.17
E147 - G147	2.14	E335 - G335	3.08	GR2.WZ.FL	16.17
E148 - G148	2.20	E336 - G336	3.08	GR3.WD.UL	16.19
E149 - G149	2.20	E340 - G340	3.08	GR3.WS.UL	16.19
E150 - G150	2.18	E342 - G342	3.09	GR3.WX.UL	16.19
E151 - G151	2.18	E350 - G350	2.17, 2.18, 3.09	GR3.WZ.UL	16.19
E152 - G152	2.19	E360	3.09	HA101 - HB101 - HC101	4.03
E153	2.19	E361	3.09	HA108 - HB108 - HC108	4.03
E154 - G154	2.19	E362	3.09	HA109 - HB109 - HC109	4.03
E156 - G156	2.19	E363	3.09	HA110 - HB110 - HC110	4.03
E157 - G157	2.19	E364	3.10	HA111 - HB111 - HC111	4.03
E158 - G158	2.20	E365	3.10	HA115 - HB115 - HC115	4.03
E160	2.20	E366	3.10	HA119 - HB119 - HC119	4.03
E161 - G161	2.21	E367	3.10	HA121 - HB121 - HC121	4.03
E162 - G162	2.21	E370	3.10	HA122 - HB122 - HC122	4.04
E163 - G163	2.21	E371	3.10	HA123 - HB123 - HC123	4.04
E165 - G165	2.21	E373	3.11	HA124 - HB124 - HC124	4.04
E166 - G166	2.21	E375	3.11	HA125 - HB125 - HC125	4.04
E167 - G167	2.21	E376	3.11	HA127 - HB127 - HC127	4.04
E168 - G168	2.22	E377	3.11	HA128 - HB128 - HC128	4.04
E169 - G169	2.22	E378	3.11	HB190	4.05
E170 - G170	2.22	E380 - G380	3.11	HB191	4.05
E171 - G171	2.23	E381	3.12	HB192	4.05
E172 - G172	2.23	E382 - G382	3.12	HBS 	12.49
E173 - G173	2.23	E383 - G383	3.12	HCS 	12.50, 12.51
E174 - G174	2.23	E384	3.12	HX002	4.06
E175 - G175	2.23	ECCENTRIC CLAMP	16.13	HX005	4.06
E176 - G176	2.23	EDGE CLAMP	16.14	K.FG500	16.16, 7.37
E177 - G177	2.24	F101	3.13	K.M.	15.27
E178 - G178	2.24	F103 - F104 - F105	3.13	K.START.2	16.16, 7.37
E179 - G179	2.24	F108	3.14	KA	12.25
E180 - G180	2.25	F110	3.14	KLEINCLEANER	16.16
E181 - G181	2.25	F111	3.14	KLEINWASHER	16.16
E182 - G182	2.26	F112	3.14	L001	5.04
E186 - G186 - C186	2.26	F114	3.14	L002	5.04
E187 - G187 - C187	2.27	F152 - F153	3.13	L003	5.04
E188 - G188 - C188	2.27	F160 - F161	3.14	L004	5.04
E189 - G189 - C189	2.28	F70	14.05	L005	5.04
E191 - G191 - C191	2.28	FAS	12.26	L006	5.04
E193 - G193 - C193	2.29	FB	12.36	L030	5.05
E194 - G194 - C194	2.29	FCS	12.37	L031	5.05
E195 - G195 - C195	2.30	FCT 	12.37	L032	5.05
E196 - G196 - C196	2.30	FE	12.39	L033	5.05
E197 - G197 - C197	2.31	FF	14.05	L034	5.06
E198 - G198 - C198	2.31	FG	12.39	L035	5.06

Item and Page Index

Item	Page	Item	Page	Item	Page
L036	5.06	N101-N111	5.22	SX003-SXL003	13.08
L040	5.06	N131	5.22	SX004-SXL004	13.09
L050	5.06	N135 - N136	5.22	T110	7.53
L051	5.06	PA-PB	12.60	T112	7.53, 8.07
L052	5.07	PDW6	14.06	T116	7.11
L053	5.07	PRE SET LEADER PLUS	15.06, 15.07	T116-X116	7.11
L054	5.07	PRE SET P322	15.14	T117	7.11
L060	5.06	PRE SET P368LR	15.12	T118 COLLET CHUCKS	7.12÷7.19, 7.22
L101 - L102	5.07	PRE SET P368XL	15.13	T118 DRILL CHUCK	7.40
L103 - L104	5.08	PRE SET PERFORMANCE	15.04, 15.05	T118 INOX	7.23
L105 - L106 - L107 - L108	5.08	PRE SET PRIME	15.10, 15.11	T118 MULTIAX	7.24
L109	5.09	PRE SET UNIKO	15.08, 15.09	T118 RETAINING PAWLS	7.35
L110	5.09	QUICK CLAMPING DEVICES	16.15	T119	7.26
L112 - L113	5.10	R100	6.03	T119.UP	7.26
L114 - L115	5.11	R101	6.03	T120 SHRINK FIT CHUCK EXTENSIONS	7.37
L116 - L117	5.11	R102	6.03	T120 SHRINK FIT CHUCKS	7.36
L116KD - L117KD 	5.11	R104-R204	6.06	T120 SHRINK FIT CHUCKS HOTBLOCK	7.36
L118	5.12	R108-R209	6.06	T121	7.22
L119	5.12	R110	6.07	T123	7.27
L120	5.13, 8.14	R111	6.07	T123.UP	7.27
L121 - L122	5.07	R112	6.08	T124	7.27
L123 - L124 - L125	5.14	R125	6.03	T125	7.28
L126 - L127	5.14	R130	6.08	T125.UP	7.28
L129	5.15	R150-R250	6.09	T126	7.28
L129KD 	5.15	R151-R251	6.12	T126.UP	7.28
L130	5.16	R152	6.12	T127	7.29
L131	5.16	R155	6.10	T127.UP	7.29
L132 - L133	5.17	R156	6.10	T128	7.38 7.39 7.42÷7.44
L134 - L135	5.17	R158	6.11	T129	7.29
L134KD - L135KD 	5.17	R159	6.11	T130-T131-T132	7.45
L136 - L137	5.16	R160-R260	6.12	T132	7.45
L138 - L139	5.16	R200	6.03	T133	7.30
L140 - L141	5.18	R201	6.04	T134	7.30
L142	5.18	R202	6.05	T135	7.30
L143 - L144	5.19	R203	6.06	T136	7.29
L150 - L151	5.18	R205	6.04	T137	7.48
L155 - L156	5.19	R206	6.04	T138	7.29
L160	5.20	R207	6.05	T139	7.32, 7.49
L170	5.20	R208	6.06	T141	7.53
L171	5.20	R210-R215-R216	6.11	T142	7.54
L174	5.20	R213	6.09	T142.KD 	7.54
L175	5.20	R220	6.09	T143	7.55
LA 	12.55	R221	6.11	T143.KD 	7.55
LB 	12.56	R225	6.05	T144	7.56
LE 	12.57	R226	6.05	T144.KD 	7.56
LIFTING CLAMP	16.13	RA	13.03	T146-T147	7.57
LZ	12.59	S110-S111	6.13	T151	7.57
M101 - M102 - M103	5.21	S120-S220	6.13	T152	7.57
M111 - M112 - M113	5.21	S121-S221	6.13	T153	7.58
M121 - M122 - M123	5.21	S122-S222	6.14	T154	7.58
M132	5.21	S123-S223	6.14	T155	7.59
M141 - M142	5.22	S180	6.14	T155.KD 	7.59
M151	5.22	S201-S202	6.12	T156	1.09, 7.59
MES	12.58	S210-S211-S212-S213	6.13	T156.KD 	7.60
MGS	12.57	S260	6.14	T156.M	7.60
MLS	12.35	SA	13.04, 13.05	T156.MKD 	7.60
MMS 	12.36	SAL	13.05	T157	7.62
MP	12.38	SX001-SXL001	13.06	T158	7.62
MRS	12.54	SX002-SXL002	13.07		

Item and Page Index

Item	Page	Item	Page	Item	Page
T159	7.63	TRIMATIC SUPER 48/9	16.10	W117-W118-WG118	1.27, 9.06
T160	1.09, 7.63	TRIMATIC SUPER 52/5,5	16.10	W122	9.07
T161 - T163	1.09, 7.63	TRIMATIC SUPER 52/7,5	16.10	W123-W124	9.07
T162	7.63	TRIMATIC SUPER 52/9	16.10	W126-W127	9.08
T164	1.09, 7.63	TS	13.30	W138	3.12, 9.08
T166	1.09, 7.64	TSL	13.30	W140	9.08
T168	7.64	TTL	13.31, 12.32	W155	9.08
T169.KD KleinDIA	7.64	TVL	13.34	W160	9.09
T170	7.64	TWL	13.33	W161	9.10
T171	7.65	TX	13.29, 13.32, 13.34, 13.38	W162	9.10
T173	7.65, 8.13	TYL	13.35	W165	9.09
T175	7.65, 8.13	TZA	13.37	W168	9.12
T177-T178	7.62	TZL	13.36	W170	9.13
T244	7.65	U101	8.07	W171	9.13
T344.KD KleinDIA	7.66	U101.KD KleinDIA	8.07	W171.UKD KleinDIA	9.13
T354.KD KleinDIA	7.66	U102	8.07	W172-W173	9.14
T356	7.61	U102.KD KleinDIA	8.07	W174-W175	9.14
T356.KD KleinDIA	7.61	U108	8.16	W176-W177	9.14
T356.M	7.61	U111KD-U112.KD KleinDIA	8.08	W179	9.14
T356.MKD KleinDIA	7.61	U111-U112	8.08	W183	9.15
T357.KD KleinDIA	7.62	U115.KD KleinDIA	8.10	W187	9.15
T501	7.47	U120	8.10	W190	9.16
TA	13.20	U120.KD KleinDIA	8.10	W190.RU-WE190.RU-WG190.RU	8.14
TAH	13.21	U121.KD-U122.KD KleinDIA	8.09	W190-WC190-WE190-WG190	9.15
TB	13.21	U121-U122	8.09	W200-W201	9.21
TC	13.22	U125	8.09	W202-W203-W204-W205	9.21
TEL	13.22	U125.KD KleinDIA	8.09	W206-W207-W208	9.21
TF	13.23	U130.KD KleinDIA	8.15	W209-W210	9.21
TGL	13.23	U140	8.14	W211-W212-W213	9.22
THL	13.24	U150	8.12	W214-W215-W216	9.22
TI	13.25	U155-U156	8.12	W250-W251	9.22
TIL	13.25	U180	8.17	W252-W253	9.22
TJ118	7.21	U181	8.17	W254	9.23
TK118	7.20	U190	8.14	W4	14.04
TLL	13.26	U201.KD KleinDIA	8.11	W6-W8-WT	14.06
TML	13.27	U201-U211-U212	8.11	WAVF	14.07
TNL	13.28	U202	8.12	WC101	1.26, 9.17
TRIMATIC 22	16.08	U202.KD KleinDIA	8.12	WC109	1.26, 9.17
TRIMATIC 22,4	16.09	U230	8.15	WC111	1.26, 9.17
TRIMATIC 25	16.08	U240	8.15	WC120	1.26, 9.17
TRIMATIC 28	16.08	U241	8.15	WC121	1.26, 9.17
TRIMATIC 32	16.06	U250	8.12	WC122	1.26, 9.18
TRIMATIC 32/90°	16.12	U260	8.15	WC123	1.27, 9.18
TRIMATIC 38/7,5	16.04	U270	8.15	WC125	1.27, 9.18
TRIMATIC 42/11	16.04	U290-U291	8.14	WC129	1.27, 9.18
TRIMATIC 43/0	16.07	U302.KD KleinDIA	8.16	WC190	1.10
TRIMATIC 45/9,5	16.04	UT100	7.41	WE100	9.19
TRIMATIC 48/6	16.04	UT105	7.41	WE101	9.19
TRIMATIC 48/9	16.04	UT118	7.40	WE112	9.19
TRIMATIC 52/5,5	16.04	W101-W102	9.05	WE150	9.19, 9.20
TRIMATIC 52/7,5	16.04	W103-W104	9.05	WE178	9.20
TRIMATIC 52/9	16.04	W105-W106	9.05	WM	14.04
TRIMATIC SUPER 22,4	16.12	W107-W108	9.05	WM8FC-WB	14.07
TRIMATIC SUPER 32/90°	16.12	W109-W110	9.05	WS7	14.04
TRIMATIC SUPER 38/7,5	16.10	W111-W112	9.05	X001	1.28
TRIMATIC SUPER 42/11	16.10	W113-W114-WG114	1.27, 9.06	X002	1.28
TRIMATIC SUPER 43/0	16.11	W114	9.06	X003	1.29
TRIMATIC SUPER 45/9,5	16.10	W115-W116-WG116	1.27, 9.06	X005	1.31
TRIMATIC SUPER 48/6	16.10	W116	9.06	X006	1.32

Item and Page Index

Item	Page	Item	Page	Item	Page
X007	1.33	Y200	11.12		
X008	1.34	YC320	8.18		
X011	1.29	YD300-YD350-YD400-YD500-YD600	7.46, 10.16		
X012	1.30	YD320	8.18		
X013	1.35	YF060-YF120	8.18		
X015	8.11	YU120-YU121	8.17		
X021	2.32	Z001	10.03		
X022	2.32	Z002	10.03		
X023	2.33	Z003	6.10, 6.11, 10.03		
X024	2.33	Z010	5.13, 10.03, 13.38		
X025	2.34	Z011	5.13, 10.04, 13.38		
X026	2.34	Z021	10.04, 10.05		
X118	7.31	Z050	10.05, 13.37		
X118 TOOL KIT FOR CNC ROUTERS	7.67, 7.68	Z051	10.06, 10.07, 7.34		
X119	7.26	Z052	10.07, 10.08, 10.09		
X123	7.27	Z052 TOR. WRENCHES	7.32, 7.33, 7.34		
X125	7.28	Z053	10.10		
X137	7.48	Z054	10.10		
X139	7.32	Z055	10.10, 10.11, 11.05, 11.06		
X500-X501-X502-X503	9.23	Z055.KD KleinDIA	11.08, 11.09		
X505-X506	9.24	Z055-Z155-Z255-Z355-Z455-Z555	11.04		
X508-X509	9.24	Z055-Z155-Z255-Z455-Z555	11.05		
X510	9.24	Z055-Z255-Z355-Z555	11.05		
X512	9.24	Z055-Z355	11.04		
X523	9.25	Z056	10.12		
X528	9.25	Z057	10.12		
X530-X531	5.12, 9.25	Z058	10.12, 13.37		
X532-X533	5.15, 9.25	Z059	10.12		
X540-X541	5.19, 9.26	Z060	10.12, 11.06		
X569	9.26	Z060.KD KleinDIA	11.09		
X900	14.08	Z090	10.13		
X901	14.08	Z091	10.13, 10.14, 7.34		
X902	14.09	Z092	7.39, 7.44, 10.14		
X903	14.09	Z455	11.06		
X904	14.09	Z455.KD KleinDIA	11.09		
X905	14.09	ZA	12.58		
X920	14.09	ZA000	10.15		
X921	14.09	ZA010	10.15, 13.38		
X922	14.10	ZA011	10.15, 13.38		
X923	14.10	ZB	11.11		
X930	14.10	ZC30-ZC35	11.12, 11.13		
X940	14.10	ZC50-ZC60-ZC70	11.14		
X950	14.10	ZE01	11.15		
XA119-XB119	8.16	ZE02	11.15		
XA119-XB119-XC119	9.26	ZE03	11.15		
XA183-XB183	8.16	ZE04	11.16		
XAH	12.23, 12.14, 9.27	ZE05	11.16		
XC123	9.26	ZE06	11.16		
XE146-XG146	8.16	ZE07	11.16		
XFC	12.38, 9.28	ZE08	11.17		
XFI	12.47, 9.28	ZE09	11.17		
XFL	12.48	ZE10	11.18		
XGE	12.24, 9.27	ZE11	11.18		
XHC	9.29, 12.52				
XW160	9.11				
XW162	9.11				
XWC	1.36, 9.18				
XZ055	9.29, 11.10				
Y100	11.12				

The B2B shop Sistemi Klein

Home | The B2B shop Sistemi Klein

Find out how our b2b e-commerce works

TO VIEW THE SHOP PLEASE
LOG IN AND START BROWSING!

[SIGN IN](#)



Our shop is thought and designed exclusively for our customers/dealers and companies of woodworking, aluminum and PVC. We decided to develop an e-commerce to meet the needs of all our customers who want to purchase a limited quantity of products. check our stock in real time or who want to speed up the purchasing process.

Following the trends, the idea of implementing a shop to our corporate website seemed to us the best solution to grow and meet the many demands of today's market. Because we at Sistemi Klein pay attention to what is new and what is happening around us. We always want the best for our customers, which is why we offer a service specifically tailored to their needs.

The Sistemi Klein e-commerce works like a classic online shop with purchasable products, personal account and shopping cart. The only special feature is that you must be logged in to the site in order to consult the prices. In this way we make the consultation of our online catalogue exclusive only to customers who really intend to make a purchase or those who are most loyal.

Home | Router bits for hand portable machines | Vhw Double Flush Trimming Bits



VHW DOUBLE FLUSH TRIMMING BITS A101

- The high quality Klein router bits satisfy the most accurate applications required by the marketplace today. In order to achieve the highest level of quality, our production department has continually invested in and equipped with the advanced technologies. Moreover we always pay detail attention to the choice of raw material, producing router bits for top market performance, precision and cutting life.
- Solid Carbide

[View Catalog](#)

[Download PDF](#)

If you are interested in this product:

[CONTACT US](#)

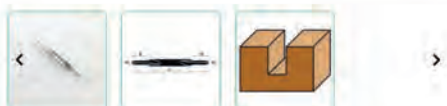

Item	S	D	B	L	Z	Price	Quantity
A101.031.R	6	3	11	65	2+1	€42.00 €21.00	- 0 + Add to Cart Availability 1 Pieces

ROUTER BITS CARE AND MAINTENANCE GUIDE

A correct cutter care is essential in order to preserve cutter performance and prolong its life. Keeping in mind our advices will guarantee the maximum tool protection, increasing its productive efficiency.

Router cutter care

Keeping cutters always clean is fundamental. After having used the router cutter in routing operations, remove it from the collet and clean it with an anticorrosion agent, like our **Klein**PROTECT, avoiding, in this way, any rust or oxidation problems. Cutting edges must be kept clean, without resin or other residues. Doing so, you will limit overheating during routing operations and avoid material finishing problems. It is important that the shank's surface is clean and smooth. In case the shank appears damaged or with corrosion signs, it is necessary to clean it with a fine wire wool and then spray it with our protective lubricant **Klein**DRYUP. Ball-bearing guides and solid pilot pins must be kept clean as well. When you handle solvents, it is recommended to wear rubber gloves to prevent skin irritation and use protective glasses.

Note: You should clean your router bits more frequently when cutting solid wood (like pine, fir, oak...) or other timbers rich with resin. The regular use of our **Klein**DRYUP over the surface of your tool, before cutting operations, will reduce the accumulation of resin and other residues, by creating a protective and resistant micro barrier which will reduce friction during cutting operations. This will allow for an increase in tool life up to 30% more.



Prolonging the life of your cutter

When working on a router table, modify and adapt the height of the cut in order to prevent the excessive wear of the cutter. In this way, the wear will spread along the cutter more evenly. The life of a flush trim router bit can be extended up to 200% more by cutting only 3mm at a time.

Keep the cutting edges efficient

Using router cutters not sharpened can lead to poor results, overheating and adding unnecessary pressure to the cutter. Therefore, the cutting edges must be kept sharp. When the router cutter does not appear sharp, it is recommended to make it re-sharpen professionally.

Cutter Maintenance

In order to maintain the cutter ready to use, it is recommended the usage of a diamond sharpening stone. This can be done by sharpening on the flat face of the tip only. Remember to hone each face an equal number of times. To carry out this operation, we suggest you to use one of our diamond sharpening stones, like our item A4F or WS7F.



Router cutter re-sharpening

If the cutter appears blunt, chipped or not sharpen, it must be re-sharpened professionally. This procedure, however, will remove a good quantity of carbide and, consequentially, weaken it. In a few cases, the chips may be so deep that it would not be possible to sharpen because the tungsten carbide left would be too thin. In many case with cheaper and less expensive cutters it can result uneconomic to re-sharpen them. Using our professional **Klein** router bits, in normal circumstances, is possible to carry out a professional re-sharpening up to 4 times. This characteristic turns our router bits into the best deal in the market in terms of duration for a given price.

Storing your router cutters

After using your cutters, it is essential that you store them in a way that the cutting edges do not touch. Therefore, avoid storing them together in a drawer or a box. The best way is to perform holes, apart from each other, with a diameter of the size of your cutter's shank, on a large piece of wood or plastic. In this way, your router cutters will not be touching and, also, will be easily recognizable. Alternatively, you can also use a specific router cutter holder.



USEFUL TIPS

In order to avoid a poor finishing is important that the router cutter is well sharpened. When the cutter edge consumes too rapidly, the cutter's wear increases and, consequentially, his productivity diminishes. If this happens, try to reduce tool's vibrations to the minimum and, increasing its feed speed, reduce also the rotation speed.

When your router cutter overheats, also turning the wood black (in jargon, burning the part), try to slow its rotation speed down, increasing, also in this case, its feed speed.

Conversion table

0"		1"		2"		3"		4"		5"		6"		7"		8"	
+	= mm	+	= mm	+	= mm	+	= mm	+	= mm	+	= mm	+	= mm	+	= mm	+	= mm
1/64	0,397	0	25,400	0	50,800	0	76,200	0	101,600	0	127,000	0	152,400	0	177,800	0	203,200
1/32	0,794	1/64	25,797	1/64	51,197	1/64	76,597	1/64	101,997	1/64	127,397	1/64	152,797	1/64	178,197	1/64	203,597
3/64	1,191	1/32	26,194	1/32	51,594	1/32	76,994	1/32	102,394	1/32	127,794	1/32	153,194	1/32	178,594	1/32	203,994
1/20	1,270	3/64	26,591	3/64	51,991	3/64	77,391	3/64	102,791	3/64	128,191	3/64	153,591	3/64	178,991	3/64	204,391
1/16	1,588	1/16	26,988	1/16	52,388	1/16	77,788	1/16	103,188	1/16	128,588	1/16	153,988	1/16	179,388	1/16	204,788
5/64	1,984	5/64	27,384	5/64	52,784	5/64	78,184	5/64	103,584	5/64	128,984	5/64	154,384	5/64	179,784	5/64	205,184
3/32	2,381	3/32	27,781	3/32	53,181	3/32	78,581	3/32	103,981	3/32	129,381	3/32	154,781	3/32	180,181	3/32	205,581
7/64	2,778	7/64	28,178	7/64	53,578	7/64	78,978	7/64	104,378	7/64	129,778	7/64	155,178	7/64	180,578	7/64	205,978
1/8	3,175	1/8	28,575	1/8	53,975	1/8	79,375	1/8	104,775	1/8	130,175	1/8	155,575	1/8	180,975	1/8	206,375
9/64	3,572	9/64	28,972	9/64	54,372	9/64	79,772	9/64	105,172	9/64	130,572	9/64	155,972	9/64	181,372	9/64	206,772
5/32	3,969	5/32	29,369	5/32	54,769	5/32	80,169	5/32	105,569	5/32	130,969	5/32	156,369	5/32	181,769	5/32	207,169
11/64	4,366	11/64	29,766	11/64	55,166	11/64	80,566	11/64	105,966	11/64	131,366	11/64	156,766	11/64	182,166	11/64	207,566
3/16	4,762	3/16	30,162	3/16	55,562	3/16	80,962	3/16	106,362	3/16	131,762	3/16	157,163	3/16	182,563	3/16	207,963
13/64	5,159	13/64	30,559	13/64	55,959	13/64	81,359	13/64	106,759	13/64	132,159	13/64	157,559	13/64	182,959	13/64	208,359
7/32	5,556	7/32	30,956	7/32	56,356	7/32	81,756	7/32	107,156	7/32	132,556	7/32	157,956	7/32	183,356	7/32	208,756
15/64	5,953	15/64	31,353	15/64	56,753	15/64	82,153	15/64	107,553	15/64	132,953	15/64	158,353	15/64	183,753	15/64	209,153
1/4	6,350	1/4	31,750	1/4	57,150	1/4	82,550	1/4	107,950	1/4	133,350	1/4	158,750	1/4	184,150	1/4	209,550
17/64	6,747	17/64	32,147	17/64	57,547	17/64	82,947	17/64	108,347	17/64	133,747	17/64	159,147	17/64	184,547	17/64	209,947
9/32	7,144	9/32	32,544	9/32	57,944	9/32	83,344	9/32	108,744	9/32	134,144	9/32	159,544	9/32	184,944	9/32	210,344
19/64	7,541	19/64	32,941	19/64	58,341	19/64	83,741	19/64	109,141	19/64	134,541	19/64	159,941	19/64	185,341	19/64	210,741
5/16	7,938	5/16	33,338	5/16	58,738	5/16	84,138	5/16	109,538	5/16	134,938	5/16	160,338	5/16	185,738	5/16	211,138
21/64	8,334	21/64	33,734	21/64	59,134	21/64	84,534	21/64	109,934	21/64	135,334	21/64	160,734	21/64	186,134	21/64	211,534
11/32	8,731	11/32	34,131	11/32	59,531	11/32	84,931	11/32	110,331	11/32	135,731	11/32	161,131	11/32	186,531	11/32	211,931
23/64	9,128	23/64	34,528	23/64	59,928	23/64	85,328	23/64	110,728	23/64	136,128	23/64	161,528	23/64	186,928	23/64	212,328
3/8	9,525	3/8	34,925	3/8	60,325	3/8	85,725	3/8	111,125	3/8	136,525	3/8	161,925	3/8	187,325	3/8	212,725
25/64	9,922	25/64	35,322	25/64	60,722	25/64	86,122	25/64	111,522	25/64	136,922	25/64	162,322	25/64	187,722	25/64	213,122
13/32	10,319	13/32	35,719	13/32	61,119	13/32	86,519	13/32	111,919	13/32	137,319	13/32	162,719	13/32	188,119	13/32	213,519
27/64	10,716	27/64	36,116	27/64	61,516	27/64	86,916	27/64	112,316	27/64	137,716	27/64	163,116	27/64	188,516	27/64	213,916
7/16	11,112	7/16	36,512	7/16	61,912	7/16	87,312	7/16	112,712	7/16	138,112	7/16	163,512	7/16	188,912	7/16	214,312
29/64	11,509	29/64	36,909	29/64	62,309	29/64	87,709	29/64	113,109	29/64	138,509	29/64	163,909	29/64	189,309	29/64	214,709
15/32	11,906	15/32	37,306	15/32	62,706	15/32	88,106	15/32	113,506	15/32	138,906	15/32	164,306	15/32	189,706	15/32	215,106
31/64	12,303	31/64	37,703	31/64	63,103	31/64	88,503	31/64	113,903	31/64	139,303	31/64	164,703	31/64	190,103	31/64	215,503
1/2	12,700	1/2	38,100	1/2	63,500	1/2	88,900	1/2	114,300	1/2	139,700	1/2	165,100	1/2	190,500	1/2	215,900
33/64	13,097	33/64	38,497	33/64	63,897	33/64	89,297	33/64	114,697	33/64	140,097	33/64	165,497	33/64	190,897	33/64	216,297
17/32	13,494	17/32	38,894	17/32	64,294	17/32	89,694	17/32	115,094	17/32	140,494	17/32	165,894	17/32	191,294	17/32	216,694
35/64	13,891	35/64	39,291	35/64	64,691	35/64	90,091	35/64	115,491	35/64	140,891	35/64	166,291	35/64	191,691	35/64	217,091
9/16	14,288	9/16	39,688	9/16	65,088	9/16	90,488	9/16	115,888	9/16	141,288	9/16	166,688	9/16	192,088	9/16	217,488
37/64	14,684	37/64	40,084	37/64	65,484	37/64	90,884	37/64	116,284	37/64	141,684	37/64	167,084	37/64	192,484	37/64	217,884
19/32	15,081	19/32	40,481	19/32	65,881	19/32	91,281	19/32	116,681	19/32	142,081	19/32	167,481	19/32	192,881	19/32	218,281
39/64	15,478	39/64	40,878	39/64	66,278	39/64	91,678	39/64	117,078	39/64	142,478	39/64	167,878	39/64	193,278	39/64	218,678
5/8	15,875	5/8	41,275	5/8	66,675	5/8	92,075	5/8	117,475	5/8	142,875	5/8	168,275	5/8	193,675	5/8	219,075
41/64	16,272	41/64	41,672	41/64	67,072	41/64	92,472	41/64	117,872	41/64	143,272	41/64	168,672	41/64	194,072	41/64	219,472
21/32	16,669	21/32	42,069	21/32	67,469	21/32	92,869	21/32	118,269	21/32	143,669	21/32	169,069	21/32	194,469	21/32	219,869
43/64	17,066	43/64	42,466	43/64	67,866	43/64	93,266	43/64	118,666	43/64	144,066	43/64	169,466	43/64	194,866	43/64	220,266
11/16	17,462	11/16	42,862	11/16	68,262	11/16	93,662	11/16	119,062	11/16	144,462	11/16	169,862	11/16	195,262	11/16	220,662
45/64	17,859	45/64	43,259	45/64	68,659	45/64	94,059	45/64	119,459	45/64	144,859	45/64	170,259	45/64	195,659	45/64	221,059
23/32	18,256	23/32	43,656	23/32	69,056	23/32	94,456	23/32	119,856	23/32	145,256	23/32	170,656	23/32	196,056	23/32	221,456
47/64	18,653	47/64	44,053	47/64	69,453	47/64	94,853	47/64	120,253	47/64	145,653	47/64	171,053	47/64	196,453	47/64	221,853
3/4	19,050	3/4	44,450	3/4	69,850	3/4	95,250	3/4	120,650	3/4	146,050	3/4	171,450	3/4	196,850	3/4	222,250
49/64	19,447	49/64	44,847	49/64	70,247	49/64	95,647	49/64	121,047	49/64	146,447	49/64	171,847	49/64	197,247	49/64	222,647
25/32	19,844	25/32	45,244	25/32	70,644	25/32	96,044	25/32	121,444	25/32	146,844	25/32	172,244	25/32	197,644	25/32	223,044
51/64	20,241	51/64	45,641	51/64	71,041	51/64	96,441	51/64	121,841	51/64	147,241	51/64	172,641	51/64	198,041	51/64	223,441
13/16	20,638	13/16	46,038	13/16	71,438	13/16	96,838	13/16	122,238	13/16	147,638	13/16	173,038	13/16	198,438	13/16	223,838
53/64	21,034	53/64	46,434	53/64	71,834	53/64	97,234	53/64	122,634	53/64	148,034	53/64	173,434	53/64	198,834	53/64	224,234
27/32	21,431	27/32	46,831	27/32	72,231	27/32	97,631	27/32	123,031	27/32	148,431	27/32	173,831	27/32	199,231	27/32	224,631
55/64	21,828	55/64	47,228	55/64	72,628	55/64	98,028	55/64	123,428	55/64	148,828	55/64	174,228	55/64	199,628	55/64	225,028
7/8	22,225	7/8	47,625	7/8	73,025	7/8	98,425	7/8	123,825	7/8	149,225	7/8	174,625	7/8	200,025	7/8	225,425
57/64	22,622	57/64	48,022	57/64	73,422	57/64	98,822	57/64	124,222	57/64	149,622	57/64	175,022	57/64	200,422	57/64	225,822
29/32	23,019	29/32	48,419	29/32	73,819	29/32	99,219	29/32	124,619	29/32	150,019	29/32	175,419	29/32	200,819	29/32	226,219
59/64	23,416	59/64	48,816	59/64	74,216	59/64	99,616	59/64	125,016	59/64	150,416	59/64	175,816	59/64	201,216	59/64	226,616
15/16	23,812	15/16	49,212	15/16	74,612	15/16	100,012	15/16	125,412	15/16	150,812	15/16	176,212	15/16	201,612	15/16	227,012
61/64	24,209	61/64	49,609	61/64	75,009	61/64	100,409	61/64	125,809	61/64	151,209	61/64	176,609	61/64	202,009	61/64	227,409

Klein

Klein

Klein

Klein

Klein

Klein

Klein



Klein

SISTEMI S.r.l. - 61122 Pesaro - Italy - Via Montanelli, 70
Tel. +39.0721.28950 - Fax +39.0721.283476
www.sistemiklein.com
info@sistemiklein.com

